

The GNU C++ Library Manual

Copyright © 2000, 2001, 2002, 2003, 2004, 2005, 2006, 2007, 2008, 2009, 2010, 2011, 2012 **FSF**

COLLABORATORS

	<i>TITLE :</i>		
	The GNU C++ Library Manual		
<i>ACTION</i>	<i>NAME</i>	<i>DATE</i>	<i>SIGNATURE</i>
WRITTEN BY	, Paolo Carlini, Phil Edwards, Doug Gregor, Benjamin Kosnik, Dhruv Matani, Jason Merrill, Mark Mitchell, Nathan Myers, Felix Natter, Stefan Olsson, Silvius Rus, Johannes Singler, Ami Tavory, and Jonathan Wakely	October 30, 2014	

REVISION HISTORY

NUMBER	DATE	DESCRIPTION	NAME

Contents

I	Introduction	1
1	Status	2
1.1	Implementation Status	2
1.1.1	C++ 1998/2003	2
1.1.1.1	Implementation Status	2
1.1.1.2	Implementation Specific Behavior	2
1.1.2	C++ 2011	4
1.1.2.1	Implementation Specific Behavior	4
1.1.3	C++ 2014	6
1.1.4	C++ TR1	6
1.1.4.1	Implementation Specific Behavior	9
1.1.5	C++ TR 24733	9
1.2	License	9
1.2.1	The Code: GPL	9
1.2.2	The Documentation: GPL, FDL	11
1.3	Bugs	12
1.3.1	Implementation Bugs	12
1.3.2	Standard Bugs	12
2	Setup	16
2.1	Prerequisites	16
2.2	Configure	17
2.3	Make	20
3	Using	21
3.1	Command Options	21
3.2	Headers	21
3.2.1	Header Files	21
3.2.2	Mixing Headers	23

3.2.3	The C Headers and namespace <code>std</code>	24
3.2.4	Precompiled Headers	24
3.3	Macros	25
3.4	Namespaces	26
3.4.1	Available Namespaces	26
3.4.2	namespace <code>std</code>	26
3.4.3	Using Namespace Composition	26
3.5	Linking	27
3.5.1	Almost Nothing	27
3.5.2	Finding Dynamic or Shared Libraries	27
3.6	Concurrency	28
3.6.1	Prerequisites	28
3.6.2	Thread Safety	28
3.6.3	Atomics	30
3.6.4	IO	30
3.6.4.1	Structure	30
3.6.4.2	Defaults	30
3.6.4.3	Future	31
3.6.4.4	Alternatives	31
3.6.5	Containers	31
3.7	Exceptions	32
3.7.1	Exception Safety	32
3.7.2	Exception Neutrality	32
3.7.3	Doing without	33
3.7.4	Compatibility	34
3.7.4.1	With C	34
3.7.4.2	With POSIX thread cancellation	34
3.7.5	Bibliography	34
3.8	Debugging Support	35
3.8.1	Using <code>g++</code>	35
3.8.2	Debug Versions of Library Binary Files	35
3.8.3	Memory Leak Hunting	36
3.8.4	Data Race Hunting	36
3.8.5	Using <code>gdb</code>	37
3.8.6	Tracking uncaught exceptions	37
3.8.7	Debug Mode	38
3.8.8	Compile Time Checking	38
3.8.9	Profile-based Performance Analysis	38

II	Standard Contents	39
4	Support	40
4.1	Types	40
4.1.1	Fundamental Types	40
4.1.2	Numeric Properties	41
4.1.3	NULL	41
4.2	Dynamic Memory	42
4.3	Termination	42
4.3.1	Termination Handlers	42
4.3.2	Verbose Terminate Handler	43
5	Diagnostics	45
5.1	Exceptions	45
5.1.1	API Reference	45
5.1.2	Adding Data to <code>exception</code>	45
5.2	Concept Checking	45
6	Utilities	47
6.1	Functors	47
6.2	Pairs	47
6.3	Memory	48
6.3.1	Allocators	48
6.3.1.1	Requirements	48
6.3.1.2	Design Issues	48
6.3.1.3	Implementation	49
6.3.1.3.1	Interface Design	49
6.3.1.3.2	Selecting Default Allocation Policy	49
6.3.1.3.3	Disabling Memory Caching	49
6.3.1.4	Using a Specific Allocator	50
6.3.1.5	Custom Allocators	50
6.3.1.6	Extension Allocators	50
6.3.1.7	Bibliography	51
6.3.2	<code>auto_ptr</code>	51
6.3.2.1	Limitations	51
6.3.2.2	Use in Containers	52
6.3.3	<code>shared_ptr</code>	53
6.3.3.1	Requirements	53
6.3.3.2	Design Issues	53
6.3.3.3	Implementation	53

6.3.3.3.1	Class Hierarchy	53
6.3.3.3.2	Thread Safety	54
6.3.3.3.3	Selecting Lock Policy	54
6.3.3.3.4	Related functions and classes	55
6.3.3.4	Use	55
6.3.3.4.1	Examples	55
6.3.3.4.2	Unresolved Issues	55
6.3.3.5	Acknowledgments	55
6.3.3.6	Bibliography	56
6.4	Traits	56
7	Strings	57
7.1	String Classes	57
7.1.1	Simple Transformations	57
7.1.2	Case Sensitivity	58
7.1.3	Arbitrary Character Types	59
7.1.4	Tokenizing	59
7.1.5	Shrink to Fit	60
7.1.6	CString (MFC)	61
8	Localization	63
8.1	Locales	63
8.1.1	locale	63
8.1.1.1	Requirements	63
8.1.1.2	Design	63
8.1.1.3	Implementation	64
8.1.1.3.1	Interacting with "C" locales	64
8.1.1.4	Future	69
8.1.1.5	Bibliography	69
8.2	Facets	70
8.2.1	ctype	70
8.2.1.1	Implementation	70
8.2.1.1.1	Specializations	70
8.2.1.2	Future	70
8.2.1.3	Bibliography	70
8.2.2	codecvt	71
8.2.2.1	Requirements	71
8.2.2.2	Design	71
8.2.2.2.1	wchar_t Size	71

8.2.2.2	Support for Unicode	72
8.2.2.2.3	Other Issues	72
8.2.2.3	Implementation	73
8.2.2.4	Use	74
8.2.2.5	Future	74
8.2.2.6	Bibliography	75
8.2.3	messages	75
8.2.3.1	Requirements	75
8.2.3.2	Design	76
8.2.3.3	Implementation	76
8.2.3.3.1	Models	76
8.2.3.3.2	The GNU Model	77
8.2.3.4	Use	77
8.2.3.5	Future	78
8.2.3.6	Bibliography	78
9	Containers	80
9.1	Sequences	80
9.1.1	list	80
9.1.1.1	list::size() is O(n)	80
9.2	Associative	80
9.2.1	Insertion Hints	80
9.2.2	bitset	81
9.2.2.1	Size Variable	81
9.2.2.2	Type String	82
9.3	Unordered Associative	83
9.3.1	Insertion Hints	83
9.3.2	Hash Code	83
9.3.2.1	Hash Code Caching Policy	83
9.4	Interacting with C	84
9.4.1	Containers vs. Arrays	84
10	Iterators	86
10.1	Predefined	86
10.1.1	Iterators vs. Pointers	86
10.1.2	One Past the End	86
11	Algorithms	88
11.1	Mutating	88
11.1.1	swap	88
11.1.1.1	Specializations	88

12 Numerics	89
12.1 Complex	89
12.1.1 complex Processing	89
12.2 Generalized Operations	89
12.3 Interacting with C	90
12.3.1 Numerics vs. Arrays	90
12.3.2 C99	90
13 Input and Output	91
13.1 Iostream Objects	91
13.2 Stream Buffers	92
13.2.1 Derived streambuf Classes	92
13.2.2 Buffering	93
13.3 Memory Based Streams	94
13.3.1 Compatibility With strstream	94
13.4 File Based Streams	95
13.4.1 Copying a File	95
13.4.2 Binary Input and Output	95
13.5 Interacting with C	96
13.5.1 Using FILE* and file descriptors	96
13.5.2 Performance	97
14 Atomics	98
14.1 API Reference	98
15 Concurrency	99
15.1 API Reference	99
III Extensions	100
16 Compile Time Checks	102
17 Debug Mode	103
17.1 Intro	103
17.2 Semantics	103
17.3 Using	104
17.3.1 Using the Debug Mode	104
17.3.2 Using a Specific Debug Container	104
17.4 Design	106
17.4.1 Goals	106
17.4.2 Methods	107

17.4.2.1	The Wrapper Model	107
17.4.2.1.1	Safe Iterators	107
17.4.2.1.2	Safe Sequences (Containers)	107
17.4.2.2	Precondition Checking	108
17.4.2.3	Release- and debug-mode coexistence	108
17.4.2.3.1	Compile-time coexistence of release- and debug-mode components	108
17.4.2.3.2	Link- and run-time coexistence of release- and debug-mode components	109
17.4.2.3.3	Alternatives for Coexistence	110
17.4.3	Other Implementations	111
18	Parallel Mode	112
18.1	Intro	112
18.2	Semantics	113
18.3	Using	113
18.3.1	Prerequisite Compiler Flags	113
18.3.2	Using Parallel Mode	114
18.3.3	Using Specific Parallel Components	114
18.4	Design	114
18.4.1	Interface Basics	114
18.4.2	Configuration and Tuning	116
18.4.2.1	Setting up the OpenMP Environment	116
18.4.2.2	Compile Time Switches	117
18.4.2.3	Run Time Settings and Defaults	117
18.4.3	Implementation Namespaces	118
18.5	Testing	118
18.6	Bibliography	118
19	Profile Mode	119
19.1	Intro	119
19.1.1	Using the Profile Mode	119
19.1.2	Tuning the Profile Mode	120
19.2	Design	121
19.2.1	Wrapper Model	121
19.2.2	Instrumentation	121
19.2.3	Run Time Behavior	121
19.2.4	Analysis and Diagnostics	121
19.2.5	Cost Model	122
19.2.6	Reports	122
19.2.7	Testing	122

19.3	Extensions for Custom Containers	122
19.4	Empirical Cost Model	123
19.5	Implementation Issues	123
19.5.1	Stack Traces	123
19.5.2	Symbolization of Instruction Addresses	123
19.5.3	Concurrency	123
19.5.4	Using the Standard Library in the Instrumentation Implementation	123
19.5.5	Malloc Hooks	123
19.5.6	Construction and Destruction of Global Objects	123
19.6	Developer Information	124
19.6.1	Big Picture	124
19.6.2	How To Add A Diagnostic	124
19.7	Diagnostics	125
19.7.1	Diagnostic Template	125
19.7.2	Containers	126
19.7.2.1	Hashtable Too Small	126
19.7.2.2	Hashtable Too Large	126
19.7.2.3	Inefficient Hash	127
19.7.2.4	Vector Too Small	127
19.7.2.5	Vector Too Large	128
19.7.2.6	Vector to Hashtable	128
19.7.2.7	Hashtable to Vector	129
19.7.2.8	Vector to List	129
19.7.2.9	List to Vector	130
19.7.2.10	List to Forward List (Slist)	130
19.7.2.11	Ordered to Unordered Associative Container	131
19.7.3	Algorithms	131
19.7.3.1	Sort Algorithm Performance	131
19.7.4	Data Locality	131
19.7.4.1	Need Software Prefetch	132
19.7.4.2	Linked Structure Locality	132
19.7.5	Multithreaded Data Access	133
19.7.5.1	Data Dependence Violations at Container Level	133
19.7.5.2	False Sharing	134
19.7.6	Statistics	134
19.8	Bibliography	134

20	The <code>mt_allocator</code>	135
20.1	Intro	135
20.2	Design Issues	135
20.2.1	Overview	135
20.3	Implementation	136
20.3.1	Tunable Parameters	136
20.3.2	Initialization	137
20.3.3	Deallocation Notes	137
20.4	Single Thread Example	138
20.5	Multiple Thread Example	139
21	The <code>bitmap_allocator</code>	141
21.1	Design	141
21.2	Implementation	141
21.2.1	Free List Store	141
21.2.2	Super Block	142
21.2.3	Super Block Data Layout	142
21.2.4	Maximum Wasted Percentage	143
21.2.5	<code>allocate</code>	143
21.2.6	<code>deallocate</code>	144
21.2.7	Questions	144
21.2.7.1	1	144
21.2.7.2	2	144
21.2.7.3	3	144
21.2.8	Locality	145
21.2.9	Overhead and Grow Policy	145
22	Policy-Based Data Structures	146
22.1	Intro	146
22.1.1	Performance Issues	146
22.1.1.1	Associative	146
22.1.1.2	Priority Que	147
22.1.2	Goals	147
22.1.2.1	Associative	147
22.1.2.1.1	Policy Choices	147
22.1.2.1.2	Underlying Data Structures	148
22.1.2.1.3	Iterators	150
22.1.2.1.3.1	Using Point Iterators for Range Operations	151
22.1.2.1.3.2	Cost to Point Iterators to Enable Range Operations	151

22.1.2.1.3.3	Invalidation Guarantees	152
22.1.2.1.4	Functional	154
22.1.2.1.4.1	erase	154
22.1.2.1.4.2	split and join	155
22.1.2.1.4.3	insert	155
22.1.2.1.4.4	operator== and operator<=	155
22.1.2.2	Priority Queues	155
22.1.2.2.1	Policy Choices	155
22.1.2.2.2	Underlying Data Structures	156
22.1.2.2.3	Binary Heaps	157
22.2	Using	158
22.2.1	Prerequisites	158
22.2.2	Organization	158
22.2.3	Tutorial	159
22.2.3.1	Basic Use	159
22.2.3.2	Configuring via Template Parameters	161
22.2.3.3	Querying Container Attributes	161
22.2.3.4	Point and Range Iteration	162
22.2.4	Examples	163
22.2.4.1	Intermediate Use	163
22.2.4.2	Querying with <code>container_traits</code>	163
22.2.4.3	By Container Method	164
22.2.4.3.1	Hash-Based	164
22.2.4.3.1.1	size Related	164
22.2.4.3.1.2	Hashing Function Related	164
22.2.4.3.2	Branch-Based	164
22.2.4.3.2.1	split or join Related	164
22.2.4.3.2.2	Node Invariants	164
22.2.4.3.2.3	trie	164
22.2.4.3.3	Priority Queues	164
22.3	Design	165
22.3.1	Concepts	165
22.3.1.1	Null Policy Classes	165
22.3.1.2	Map and Set Semantics	165
22.3.1.2.1	Distinguishing Between Maps and Sets	165
22.3.1.2.2	Alternatives to <code>std::multiset</code> and <code>std::multimap</code>	166
22.3.1.3	Iterator Semantics	169
22.3.1.3.1	Point and Range Iterators	169
22.3.1.3.2	Distinguishing Point and Range Iterators	169

22.3.1.3.3	Invalidation Guarantees	170
22.3.1.4	Genericity	171
22.3.1.4.1	Tag	172
22.3.1.4.2	Traits	173
22.3.2	By Container	173
22.3.2.1	hash	173
22.3.2.1.1	Interface	173
22.3.2.1.2	Details	174
22.3.2.1.2.1	Hash Policies	174
22.3.2.1.2.2	General	174
22.3.2.1.2.3	Range Hashing	176
22.3.2.1.2.4	Ranged Hash	177
22.3.2.1.2.5	Implementation	177
22.3.2.1.2.6	Range-Hashing and Ranged-Hashes in Collision-Chaining Tables	178
22.3.2.1.2.7	Probing tables	179
22.3.2.1.2.8	Pre-Defined Policies	179
22.3.2.1.2.9	Resize Policies	181
22.3.2.1.2.10	General	181
22.3.2.1.2.11	Size Policies	181
22.3.2.1.2.12	Trigger Policies	181
22.3.2.1.2.13	Implementation	182
22.3.2.1.2.14	Decomposition	182
22.3.2.1.2.15	Predefined Policies	187
22.3.2.1.2.16	Controlling Access to Internals	187
22.3.2.1.2.17	Policy Interactions	187
22.3.2.1.2.18	probe/size/trigger	188
22.3.2.1.2.19	hash/trigger	188
22.3.2.1.2.20	equivalence functors/storing hash values/hash	188
22.3.2.1.2.21	size/load-check trigger	188
22.3.2.2	tree	188
22.3.2.2.1	Interface	188
22.3.2.2.2	Details	189
22.3.2.2.2.1	Node Invariants	189
22.3.2.2.2.2	Node Iterators	192
22.3.2.2.2.3	Node Updator	192
22.3.2.2.2.4	Split and Join	197
22.3.2.3	Trie	197
22.3.2.3.1	Interface	197
22.3.2.3.2	Details	198

22.3.2.3.2.1	Element Access Traits	198
22.3.2.3.2.2	Node Invariants	199
22.3.2.3.2.3	Split and Join	200
22.3.2.4	List	200
22.3.2.4.1	Interface	200
22.3.2.4.2	Details	201
22.3.2.4.2.1	Underlying Data Structure	201
22.3.2.4.2.2	Policies	202
22.3.2.4.2.3	Use in Multimaps	203
22.3.2.5	Priority Queue	203
22.3.2.5.1	Interface	203
22.3.2.5.2	Details	204
22.3.2.5.2.1	Iterators	204
22.3.2.5.2.2	Underlying Data Structure	205
22.3.2.5.2.3	Traits	206
22.4	Testing	207
22.4.1	Regression	207
22.4.2	Performance	207
22.4.2.1	Hash-Based	207
22.4.2.1.1	Text <code>find</code>	207
22.4.2.1.1.1	Description	207
22.4.2.1.1.2	Results	208
22.4.2.1.1.3	Observations	209
22.4.2.1.2	Integer <code>find</code>	209
22.4.2.1.2.1	Description	209
22.4.2.1.2.2	Results	209
22.4.2.1.2.3	Observations	212
22.4.2.1.3	Integer Subscript <code>find</code>	212
22.4.2.1.3.1	Description	212
22.4.2.1.3.2	Results	212
22.4.2.1.3.3	Observations	215
22.4.2.1.4	Integer Subscript <code>insert</code>	215
22.4.2.1.4.1	Description	215
22.4.2.1.4.2	Results	215
22.4.2.1.4.3	Observations	218
22.4.2.1.5	Integer <code>find</code> with Skewed-Distribution	218
22.4.2.1.5.1	Description	218
22.4.2.1.5.2	Results	219
22.4.2.1.5.3	Observations	220

22.4.2.1.6	Erase Memory Use	220
22.4.2.1.6.1	Description	220
22.4.2.1.6.2	Results	220
22.4.2.1.6.3	Observations	222
22.4.2.2	Branch-Based	222
22.4.2.2.1	Text <code>insert</code>	222
22.4.2.2.1.1	Description	222
22.4.2.2.1.2	Results	222
22.4.2.2.1.3	Observations	224
22.4.2.2.2	Text <code>find</code>	224
22.4.2.2.2.1	Description	224
22.4.2.2.2.2	Results	225
22.4.2.2.2.3	Observations	225
22.4.2.2.3	Text <code>find</code> with Locality-of-Reference	226
22.4.2.2.3.1	Description	226
22.4.2.2.3.2	Results	226
22.4.2.2.3.3	Observations	227
22.4.2.2.4	<code>split</code> and <code>join</code>	227
22.4.2.2.4.1	Description	227
22.4.2.2.4.2	Results	227
22.4.2.2.4.3	Observations	228
22.4.2.2.5	Order-Statistics	229
22.4.2.2.5.1	Description	229
22.4.2.2.5.2	Results	229
22.4.2.2.5.3	Observations	230
22.4.2.3	Multimap	230
22.4.2.3.1	Text <code>find</code> with Small Secondary-to-Primary Key Ratios	230
22.4.2.3.1.1	Description	230
22.4.2.3.1.2	Results	230
22.4.2.3.1.3	Observations	233
22.4.2.3.2	Text <code>find</code> with Large Secondary-to-Primary Key Ratios	234
22.4.2.3.2.1	Description	234
22.4.2.3.2.2	Results	234
22.4.2.3.2.3	Observations	237
22.4.2.3.3	Text <code>insert</code> with Small Secondary-to-Primary Key Ratios	237
22.4.2.3.3.1	Description	237
22.4.2.3.3.2	Results	237
22.4.2.3.3.3	Observations	240
22.4.2.3.4	Text <code>insert</code> with Small Secondary-to-Primary Key Ratios	241

22.4.2.3.4.1	Description	241
22.4.2.3.4.2	Results	241
22.4.2.3.4.3	Observations	244
22.4.2.3.5	Text <code>insert</code> with Small Secondary-to-Primary Key Ratios Memory Use	244
22.4.2.3.5.1	Description	244
22.4.2.3.5.2	Results	244
22.4.2.3.5.3	Observations	247
22.4.2.3.6	Text <code>insert</code> with Small Secondary-to-Primary Key Ratios Memory Use	248
22.4.2.3.6.1	Description	248
22.4.2.3.6.2	Results	248
22.4.2.3.6.3	Observations	251
22.4.2.4	Priority Queue	251
22.4.2.4.1	Text <code>push</code>	251
22.4.2.4.1.1	Description	251
22.4.2.4.1.2	Results	251
22.4.2.4.1.3	Observations	253
22.4.2.4.2	Text <code>push</code> and <code>pop</code>	253
22.4.2.4.2.1	Description	253
22.4.2.4.2.2	Results	254
22.4.2.4.2.3	Observations	255
22.4.2.4.3	Integer <code>push</code>	255
22.4.2.4.3.1	Description	255
22.4.2.4.3.2	Results	256
22.4.2.4.3.3	Observations	257
22.4.2.4.4	Integer <code>push</code>	257
22.4.2.4.4.1	Description	257
22.4.2.4.4.2	Results	257
22.4.2.4.4.3	Observations	258
22.4.2.4.5	Text <code>pop</code> Memory Use	259
22.4.2.4.5.1	Description	259
22.4.2.4.5.2	Results	259
22.4.2.4.5.3	Observations	260
22.4.2.4.6	Text <code>join</code>	260
22.4.2.4.6.1	Description	260
22.4.2.4.6.2	Results	260
22.4.2.4.6.3	Observations	261
22.4.2.4.7	Text <code>modify Up</code>	262
22.4.2.4.7.1	Description	262
22.4.2.4.7.2	Results	262

22.4.2.4.7.3	Observations	263
22.4.2.4.8	Text modify Down	264
22.4.2.4.8.1	Description	264
22.4.2.4.8.2	Results	264
22.4.2.4.8.3	Observations	265
22.4.2.5	Observations	266
22.4.2.5.1	Associative	266
22.4.2.5.1.1	Underlying Data-Structure Families	266
22.4.2.5.1.2	Hash-Based Containers	266
22.4.2.5.1.3	Hash Policies	266
22.4.2.5.1.4	Branch-Based Containers	266
22.4.2.5.1.5	Mapping-Semantics	267
22.4.2.5.2	Priority_Queue	268
22.4.2.5.2.1	Complexity	268
22.4.2.5.2.2	Amortized push and pop operations	269
22.4.2.5.2.3	Graph Algorithms	269
22.5	Acknowledgments	269
22.6	Bibliography	270
23	HP/SGI Extensions	272
23.1	Backwards Compatibility	272
23.2	Deprecated	272
24	Utilities	274
25	Algorithms	275
26	Numerics	276
27	Iterators	277
28	Input and Output	278
28.1	Derived filebufs	278
29	Demangling	279
30	Concurrency	281
30.1	Design	281
30.1.1	Interface to Locks and Mutexes	281
30.1.2	Interface to Atomic Functions	281
30.2	Implementation	282
30.2.1	Using Builtin Atomic Functions	282
30.2.2	Thread Abstraction	283
30.3	Use	283

IV	Appendices	285
A	Contributing	286
A.1	Contributor Checklist	286
A.1.1	Reading	286
A.1.2	Assignment	286
A.1.3	Getting Sources	286
A.1.4	Submitting Patches	287
A.2	Directory Layout and Source Conventions	287
A.3	Coding Style	289
A.3.1	Bad Identifiers	289
A.3.2	By Example	292
A.4	Design Notes	299
B	Porting and Maintenance	315
B.1	Configure and Build Hacking	315
B.1.1	Prerequisites	315
B.1.2	Overview	315
B.1.2.1	General Process	315
B.1.2.2	What Comes from Where	316
B.1.3	Configure	316
B.1.3.1	Storing Information in non-AC files (like configure.host)	316
B.1.3.2	Coding and Commenting Conventions	316
B.1.3.3	The acinclude.m4 layout	316
B.1.3.4	GLIBCXX_ENABLE, the <code>--enable</code> maker	317
B.1.4	Make	318
B.2	Writing and Generating Documentation	319
B.2.1	Introduction	319
B.2.2	Generating Documentation	319
B.2.3	Doxygen	320
B.2.3.1	Prerequisites	320
B.2.3.2	Generating the Doxygen Files	320
B.2.3.3	Debugging Generation	321
B.2.3.4	Markup	321
B.2.4	Docbook	322
B.2.4.1	Prerequisites	322
B.2.4.2	Generating the DocBook Files	323
B.2.4.3	Debugging Generation	324
B.2.4.4	Editing and Validation	324

B.2.4.5	File Organization and Basics	325
B.2.4.6	Markup By Example	326
B.3	Porting to New Hardware or Operating Systems	326
B.3.1	Operating System	327
B.3.2	CPU	328
B.3.3	Character Types	328
B.3.4	Thread Safety	330
B.3.5	Numeric Limits	331
B.3.6	Libtool	331
B.4	Test	332
B.4.1	Organization	332
B.4.1.1	Directory Layout	332
B.4.1.2	Naming Conventions	333
B.4.2	Running the Testsuite	334
B.4.2.1	Basic	334
B.4.2.2	Variations	334
B.4.2.3	Permutations	336
B.4.3	Writing a new test case	336
B.4.4	Test Harness and Utilities	337
B.4.4.1	Dejagnu Harness Details	337
B.4.4.2	Utilities	338
B.4.5	Special Topics	339
B.4.5.1	Qualifying Exception Safety Guarantees	339
B.4.5.1.1	Overview	339
B.4.5.1.2	Existing tests	339
B.4.5.1.3	C++11 Requirements Test Sequence Descriptions	340
B.5	ABI Policy and Guidelines	340
B.5.1	The C++ Interface	340
B.5.2	Versioning	341
B.5.2.1	Goals	341
B.5.2.2	History	341
B.5.2.3	Prerequisites	347
B.5.2.4	Configuring	348
B.5.2.5	Checking Active	348
B.5.3	Allowed Changes	349
B.5.4	Prohibited Changes	349
B.5.5	Implementation	349
B.5.6	Testing	350
B.5.6.1	Single ABI Testing	350

B.5.6.2	Multiple ABI Testing	351
B.5.7	Outstanding Issues	352
B.5.8	Bibliography	352
B.6	API Evolution and Deprecation History	352
B.6.1	3.0	352
B.6.2	3.1	353
B.6.3	3.2	353
B.6.4	3.3	353
B.6.5	3.4	353
B.6.6	4.0	354
B.6.7	4.1	354
B.6.8	4.2	354
B.6.9	4.3	355
B.6.10	4.4	356
B.6.11	4.5	356
B.7	Backwards Compatibility	357
B.7.1	First	357
B.7.1.1	No <code>ios_base</code>	357
B.7.1.2	No <code>cout</code> in <code><ostream.h></code> , no <code>cin</code> in <code><istream.h></code>	357
B.7.2	Second	357
B.7.2.1	Namespace <code>std::</code> not supported	357
B.7.2.2	Illegal iterator usage	358
B.7.2.3	<code>isspace</code> from <code><cctype></code> is a macro	358
B.7.2.4	No <code>vector::at</code> , <code>deque::at</code> , <code>string::at</code>	359
B.7.2.5	No <code>std::char_traits<char>::eof</code>	359
B.7.2.6	No <code>string::clear</code>	359
B.7.2.7	Removal of <code>ostream::form</code> and <code>istream::scan</code> extensions	360
B.7.2.8	No <code>basic_stringbuf</code> , <code>basic_stringstream</code>	360
B.7.2.9	Little or no wide character support	361
B.7.2.10	No templated iostreams	361
B.7.2.11	Thread safety issues	361
B.7.3	Third	362
B.7.3.1	Pre-ISO headers moved to backwards or removed	362
B.7.3.2	Extension headers <code>hash_map</code> , <code>hash_set</code> moved to ext or backwards	363
B.7.3.3	No <code>ios::nocreate/ios::noreplace</code> .	364
B.7.3.4	No <code>stream::attach(int fd)</code>	365
B.7.3.5	Support for C++98 dialect.	365
B.7.3.6	Support for C++TR1 dialect.	366
B.7.3.7	Support for C++11 dialect.	367
B.7.3.8	<code>Container::iterator_type</code> is not necessarily <code>Container::value_type*</code>	371
B.7.4	Bibliography	371

C	Free Software Needs Free Documentation	372
D	GNU General Public License version 3	374
E	GNU Free Documentation License	383
31	Index	389

List of Figures

22.1 Node Invariants	148
22.2 Underlying Associative Data Structures	149
22.3 Range Iteration in Different Data Structures	151
22.4 Point Iteration in Hash Data Structures	152
22.5 Effect of erase in different underlying data structures	153
22.6 Underlying Priority Queue Data Structures	157
22.7 Exception Hierarchy	159
22.8 Non-unique Mapping Standard Containers	167
22.9 Effect of embedded lists in <code>std::multimap</code>	167
22.10 Non-unique Mapping Containers	168
22.11 Point Iterator Hierarchy	170
22.12 Invalidation Guarantee Tags Hierarchy	171
22.13 Container Tag Hierarchy	172
22.14 Hash functions, ranged-hash functions, and range-hashing functions	175
22.15 Insert hash sequence diagram	178
22.16 Insert hash sequence diagram with a null policy	179
22.17 Hash policy class diagram	180
22.18 Balls and bins	181
22.19 Insert resize sequence diagram	183
22.20 Standard resize policy trigger sequence diagram	185
22.21 Standard resize policy size sequence diagram	186
22.22 Tree node invariants	190
22.23 Tree node invalidation	191
22.24 A tree and its update policy	192
22.25 Restoring node invariants	193
22.26 Insert update sequence	194
22.27 Useless update path	196
22.28 A PATRICIA trie	199
22.29 A trie and its update policy	200
22.30 A simple list	201

22.31	The counter algorithm	202
22.32	Underlying Priority-Queue Data-Structures.	205
22.33	Priority-Queue Data-Structure Tags.	206
B.1	Configure and Build File Dependencies	316

List of Tables

1.1	C++ 1998/2003 Implementation Status	3
1.2	C++ 2011 Implementation Status	5
1.3	C++ 2014 Implementation Status	6
1.4	C++ Technical Specifications Implementation Status	7
1.5	C++ TR1 Implementation Status	8
1.6	C++ TR 24733 Implementation Status	10
3.1	C++ Command Options	21
3.2	C++ 1998 Library Headers	22
3.3	C++ 1998 Library Headers for C Library Facilities	22
3.4	C++ 2011 Library Headers	22
3.5	C++ 2011 Library Headers for C Library Facilities	22
3.6	C++ TR 1 Library Headers	22
3.7	C++ TR 1 Library Headers for C Library Facilities	22
3.8	C++ TR 24733 Decimal Floating-Point Header	23
3.9	C++ ABI Headers	23
3.10	Extension Headers	23
3.11	Extension Debug Headers	24
3.12	Extension Profile Headers	24
3.13	Extension Parallel Headers	24
17.1	Debugging Containers	105
17.2	Debugging Containers C++11	105
18.1	Parallel Algorithms	115
19.1	Profile Code Location	121
19.2	Profile Diagnostics	125
21.1	Bitmap Allocator Memory Map	142
B.1	Doxygen Prerequisites	320

B.2	HTML to Doxygen Markup Comparison	323
B.3	Docbook Prerequisites	323
B.4	HTML to Docbook XML Markup Comparison	326
B.5	Docbook XML Element Use	326
B.6	Extension Allocators	354
B.7	Extension Allocators Continued	354

Part I

Introduction

Chapter 1

Status

1.1 Implementation Status

1.1.1 C++ 1998/2003

1.1.1.1 Implementation Status

This status table is based on the table of contents of ISO/IEC 14882:2003.

This page describes the C++ support in mainline GCC SVN, not in any particular release.

1.1.1.2 Implementation Specific Behavior

The ISO standard defines the following phrase:

[1.3.5] implementation-defined behavior Behavior, for a well-formed program construct and correct data, that depends on the implementation *and that each implementation shall document*.

We do so here, for the C++ library only. Behavior of the compiler, linker, runtime loader, and other elements of "the implementation" are documented elsewhere. Everything listed in Annex B, Implementation Qualities, are also part of the compiler, not the library.

For each entry, we give the section number of the standard, when applicable. This list is probably incomplet and inkorrekt.

[1.9]/11 #3 If `isatty(3)` is true, then interactive stream support is implied.

[17.4.4.5] Non-reentrant functions are probably best discussed in the various sections on multithreading (see above).

[18.1]/4 The type of `NULL` is described under **Support**.

[18.3]/8 Even though it's listed in the library sections, `libstdc++` has zero control over what the cleanup code hands back to the runtime loader. Talk to the compiler people. :-)

[18.4.2.1]/5 (`bad_alloc`), [18.5.2]/5 (`bad_cast`), [18.5.3]/5 (`bad_typeid`), [18.6.1]/8 (`exception`), [18.6.2.1]/5 (`bad_exception`): The `what()` member function of class `std::exception`, and these other classes publicly derived from it, simply returns the name of the class. But they are the *mangled* names; you will need to call `c++filt` and pass the names as command-line parameters to demangle them, or call a **runtime demangler function**. (The classes in `<stdexcept>` have constructors which require an argument to use later for `what()` calls, so the problem of `what()`'s value does not arise in most user-defined exceptions.)

[18.5.1]/7 The return value of `std::type_info::name()` is the mangled type name (see the previous entry for more).

Section	Description	Status	Comments
<i>18</i>	<i>Language support</i>		
18.1	Types	Y	
18.2	Implementation properties	Y	
18.2.1	Numeric Limits		
18.2.1.1	Class template <code>numeric_limits</code>	Y	
18.2.1.2	<code>numeric_limits</code> members	Y	
18.2.1.3	<code>float_round_style</code>	Y	
18.2.1.4	<code>float_denorm_style</code>	Y	
18.2.1.5	<code>numeric_limits</code> specializations	Y	
18.2.2	C Library	Y	
18.3	Start and termination	Y	
18.4	Dynamic memory management	Y	
18.5	Type identification		
18.5.1	Class <code>type_info</code>	Y	
18.5.2	Class <code>bad_cast</code>	Y	
18.5.3	Class <code>bad_typeid</code>	Y	
18.6	Exception handling		
18.6.1	Class <code>exception</code>	Y	
18.6.2	Violation exception-specifications	Y	
18.6.3	Abnormal termination	Y	
18.6.4	<code>uncaught_exception</code>	Y	
18.7	Other runtime support	Y	
<i>19</i>	<i>Diagnostics</i>		
19.1	Exception classes	Y	
19.2	Assertions	Y	
19.3	Error numbers	Y	
<i>20</i>	<i>General utilities</i>		
20.1	Requirements	Y	
20.2	Utility components		
20.2.1	Operators	Y	
20.2.2	<code>pair</code>	Y	
20.3	Function objects		
20.3.1	Base	Y	
20.3.2	Arithmetic operation	Y	
20.3.3	Comparisons	Y	
20.3.4	Logical operations	Y	
20.3.5	Negators	Y	
20.3.6	Binders	Y	
20.3.7	Adaptors for pointers to functions	Y	
20.3.8	Adaptors for pointers to members	Y	
20.4	Memory		
20.4.1	The default allocator	Y	
20.4.2	Raw storage iterator	Y	
20.4.3	Temporary buffers	Y	
20.4.4	Specialized algorithms	Y	
20.4.4.1	<code>uninitialized_copy</code>	Y	
20.4.4.2	<code>uninitialized_fill</code>	Y	
20.4.4.3	<code>uninitialized_fill_n</code>	Y	
20.4.5	Class template <code>auto_ptr</code>	Y	
20.4.6	C library	Y	
<i>21</i>	<i>Strings</i>		
21.1	Character traits		
21.1.1	Character traits requirements	Y	
21.1.2	<code>char_traits</code>	Y	

[20.1.5]/5 "Implementors are encouraged to supply libraries that can accept allocators that encapsulate more general memory models and that support non-equal instances. In such implementations, any requirements imposed on allocators by containers beyond those requirements that appear in Table 32, and the semantics of containers and algorithms when allocator instances compare non-equal, are implementation-defined." There is experimental support for non-equal allocators in the standard containers in C++98 mode. There are no additional requirements on allocators. It is undefined behaviour to swap two containers if their allocators are not equal.

[21.1.3.1]/3,4, [21.1.3.2]/2, [23.*]'s `foo::iterator`, [27.*]'s `foo::*_type`, others... Nope, these types are called implementation-defined because you shouldn't be taking advantage of their underlying types. Listing them here would defeat the purpose. :-)

[21.1.3.1]/5 I don't really know about the `mbstate_t` stuff... see the [codecvr notes](#) for what does exist.

[22.*] Anything and everything we have on locale implementation will be described under [Localization](#).

[26.2.8]/9 I have no idea what `complex<T>`'s `pow(0, 0)` returns.

[27.4.2.4]/2 Calling `std::ios_base::sync_with_stdio` after I/O has already been performed on the standard stream objects will flush the buffers, and destroy and recreate the underlying buffer instances. Whether or not the previously-written I/O is destroyed in this process depends mostly on the `--enable-libio` choice: for `stdio`, if the written data is already in the `stdio` buffer, the data may be completely safe!

[27.6.1.1.2], [27.6.2.3] The I/O sentry ctor and dtor can perform additional work than the minimum required. We are not currently taking advantage of this yet.

[27.7.1.3]/16, [27.8.1.4]/10 The effects of `pubsetbuf/setbuf` are described in the [Input and Output](#) chapter.

[27.8.1.4]/16 Calling `fstream::sync` when a get area exists will... whatever `fflush()` does, I think.

1.1.2 C++ 2011

This table is based on the table of contents of ISO/IEC JTC1 SC22 WG21 Doc No: N3290 Date: 2011-04-11 Final Draft International Standard, Standard for Programming Language C++

In this implementation `-std=gnu++11` or `-std=c++11` flags must be used to enable language and library features. See [dialect](#) options. The pre-defined symbol `__cplusplus` is used to check for the presence of the required flag.

This page describes the C++11 support in mainline GCC SVN, not in any particular release.

1.1.2.1 Implementation Specific Behavior

For behaviour which is also specified by the 1998 and 2003 standards, see [C++ 1998/2003 Implementation Specific Behavior](#). This section only documents behaviour which is new in the 2011 standard.

20.8.9.1.3 [*func.bind.place*]/1 There are 29 placeholders defined and the placeholder types are `CopyAssignable`.

23.5.4.2 [*unord.map.cnstr*], 23.5.5.2 [*unord.multimap.cnstr*], 23.5.6.2 [*unord.set.cnstr*], 23.5.7.2 [*unord.multiset.cnstr*] The default bucket count is 10 for the default constructors and 0 for the range constructors and initializer-list constructors.

30.2.3 [*thread.req.native*]/1 `native_handle_type` and `native_handle` are provided. The handle types are defined in terms of the Gthreads abstraction layer.

- `thread`: The native handle type is a typedef for `__gthread_t` i.e. `pthread_t` when GCC is configured with the `posix` thread model. The value of the native handle is undefined for a thread which is not joinable.
- `mutex` and `timed_mutex`: The native handle type is `__gthread_mutex_t*` i.e. `pthread_mutex_t*` for the `posix` thread model.
- `recursive_mutex` and `recursive_timed_mutex`: The native handle type is `__gthread_recursive_mutex_t*` i.e. `pthread_mutex_t*` for the `posix` thread model.
- `condition_variable`: The native handle type is `__gthread_cond_t*` i.e. `pthread_cond_t*` for the `posix` thread model.

30.6.1 [*futures.overview*]/2 `launch` is a scoped enumeration type with overloaded operators to support bitmask operations. There are no additional bitmask elements defined.

Section	Description	Status	Comments
<i>18</i>	<i>Language support</i>		
18.1	General	Y	
18.2	Types	Partial	Missing offsetof
18.3	Implementation properties		
18.3.2	Numeric Limits		
18.3.2.3	Class template numeric_limits	Y	
18.3.2.4	numeric_limits members	Y	
18.3.2.5	float_round_style	N	
18.3.2.6	float_denorm_style	N	
18.3.2.7	numeric_limits specializations	Y	
18.3.3	C Library	Y	
18.4	Integer types		
18.4.1	Header <cstdint> synopsis	Y	
18.5	Start and termination	Partial	C library dependency for quick_exit, at_quick_exit
18.6	Dynamic memory management	Y	
18.7	Type identification		
18.7.1	Class type_info	Y	
18.7.2	Class bad_cast	Y	
18.7.3	Class bad_typeid	Y	
18.8	Exception handling		
18.8.1	Class exception	Y	
18.8.2	Class bad_exception	Y	
18.8.3	Abnormal termination	Y	
18.8.4	uncaught_exception	Y	
18.8.5	Exception Propagation	Y	
18.8.6	nested_exception	Y	
18.9	Initializer lists		
18.9.1	Initializer list constructors	Y	
18.9.2	Initializer list access	Y	
18.9.3	Initializer list range access	Y	
18.10	Other runtime support	Y	
<i>19</i>	<i>Diagnostics</i>		
19.1	General	Y	
19.2	Exception classes	Partial	Missing const char* constructors.
19.3	Assertions	Y	
19.4	Error numbers	Y	
19.5	System error support		
19.5.1	Class error_category	Y	
19.5.2	Class error_code	Y	
19.5.3	Class error_condition	Y	
19.5.4	Comparison operators	Y	
19.5.5	Class system_error	Partial	Missing const char* constructors.
<i>20</i>	<i>General utilities</i>		
20.1	General		
20.2	Utility components		
20.2.1	Operators	Y	
20.2.2	Swap	Y	
20.2.3	forward and move helpers	Y	
20.2.4	Function template declval	Y	
20.3	Pairs		
20.3.1	In general		
20.3.2	Class template pair	Y	

1.1.3 C++ 2014

In this implementation `-std=gnu++1y` or `-std=c++1y` flags must be used to enable language and library features. See [dialect](#) options. The pre-defined symbol `__cplusplus` is used to check for the presence of the required flag.

This page describes the C++14 and library TS support in mainline GCC SVN, not in any particular release.

Paper	Title	Status	Comments
N3669	Fixing constexpr member functions without const	Y	
N3668	<code>exchange()</code> utility function	Y	
N3670	Wording for Addressing Tuples by Type	Y	
N3656	<code>make_unique</code>	Y	
N3462	<code>std::result_of</code> and SFINAE	Y	
N3545	An Incremental Improvement to <code>integral_constant</code>	Y	
N3642	User-defined Literals for Standard Library Types	Y	
N3671	Making non-modifying sequence operations more robust	Y	
N3654	Quoted Strings Library Proposal	Y	
N3469	Constexpr Library Additions: chrono	Y	
N3470	Constexpr Library Additions: containers	Y	
N3471	Constexpr Library Additions: utilities	Y	
N3658	Compile-time integer sequences	Y	
N3659	Shared Locking in C++	Y	Need tests
N3421	Making Operator Functors <code>greater<></code>	Y	
N3657	Adding heterogeneous comparison lookup to associative containers	WIP	
N3655	TransformationTraits Redux	Y	
N3644	Null Forward Iterators	N	

Table 1.3: C++ 2014 Implementation Status

1.1.4 C++ TR1

This table is based on the table of contents of ISO/IEC DTR 19768 Doc No: N1836=05-0096 Date: 2005-06-24 Draft Technical Report on C++ Library Extensions

In this implementation the header names are prefixed by `tr1/`, for instance `<tr1/functional>`, `<tr1/memory>`, and so on.

This page describes the TR1 support in mainline GCC SVN, not in any particular release.

Paper	Title	Status	Comments
N3662	C++ Dynamic Arrays	N	Array Extensions TS
N3783	Network byte order conversion	N	Library Fundamentals TS
N3793	A proposal to add a utility class to represent optional objects	Y	Library Fundamentals TS
N3804	Any library proposal	N	Library Fundamentals TS
N3843	A SFINAE-Friendly <code>std::common_type</code> (option 2 was approved)	N	Library Fundamentals TS
N3866	Invocation type traits, but dropping <code>function_call_operator</code> .	N	Library Fundamentals TS
N3905	Faster string searching (Boyer-Moore et al.)	N	Library Fundamentals TS
N3915	<code>apply()</code> call a function with arguments from a tuple	N	Library Fundamentals TS
N3916	Polymorphic memory resources	N	Library Fundamentals TS
N3920	Extending <code>shared_ptr</code> to support arrays	N	Library Fundamentals TS
N3921	<code>string_view</code> : a non-owning reference to a string	Y	Library Fundamentals TS
N3923	A SFINAE-Friendly <code>std::iterator_traits</code>	N	Library Fundamentals TS
N3925	A sample proposal	N	Library Fundamentals TS
N3932	Variable Templates For Type Traits	N	Library Fundamentals TS
N3940	File System	WIP	

Table 1.4: C++ Technical Specifications Implementation Status

Section	Description	Status	Comments
2	<i>General Utilities</i>		
2.1	Reference wrappers		
2.1.1	Additions to header <functional> synopsis	Y	
2.1.2	Class template reference_wrapper		
2.1.2.1	reference_wrapper construct/copy/destroy	Y	
2.1.2.2	reference_wrapper assignment	Y	
2.1.2.3	reference_wrapper access	Y	
2.1.2.4	reference_wrapper invocation	Y	
2.1.2.5	reference_wrapper helper functions	Y	
2.2	Smart pointers		
2.2.1	Additions to header <memory> synopsis	Y	
2.2.2	Class bad_weak_ptr	Y	
2.2.3	Class template shared_ptr		Uses code from boost::shared_ptr .
2.2.3.1	shared_ptr constructors	Y	
2.2.3.2	shared_ptr destructor	Y	
2.2.3.3	shared_ptr assignment	Y	
2.2.3.4	shared_ptr modifiers	Y	
2.2.3.5	shared_ptr observers	Y	
2.2.3.6	shared_ptr comparison	Y	
2.2.3.7	shared_ptr I/O	Y	
2.2.3.8	shared_ptr specialized algorithms	Y	
2.2.3.9	shared_ptr casts	Y	
2.2.3.10	get_deleter	Y	
2.2.4	Class template weak_ptr		
2.2.4.1	weak_ptr constructors	Y	
2.2.4.2	weak_ptr destructor	Y	
2.2.4.3	weak_ptr assignment	Y	
2.2.4.4	weak_ptr modifiers	Y	
2.2.4.5	weak_ptr observers	Y	
2.2.4.6	weak_ptr comparison	Y	
2.2.4.7	weak_ptr specialized algorithms	Y	
2.2.5	Class template enable_s hared_from_this	Y	
3	<i>Function Objects</i>		
3.1	Definitions	Y	
3.2	Additions to <functional> synopsis	Y	
3.3	Requirements	Y	
3.4	Function return types	Y	
3.5	Function template mem_fn	Y	
3.6	Function object binders		
3.6.1	Class template is_bind_expression	Y	
3.6.2	Class template is_placeholder	Y	
3.6.3	Function template bind	Y	
3.6.4	Placeholders	Y	
3.7	Polymorphic function wrappers		
	Class		

1.1.4.1 Implementation Specific Behavior

For behaviour which is specified by the 1998 and 2003 standards, see [C++ 1998/2003 Implementation Specific Behavior](#). This section documents behaviour which is required by TR1.

3.6.4 [*tr.func.bind.place*]/1 There are 29 placeholders defined and the placeholder types are Assignable.

1.1.5 C++ TR 24733

This table is based on the table of contents of ISO/IEC TR 24733 Date: 2009-08-28 Extension for the programming language C++ to support decimal floating-point arithmetic

This page describes the TR 24733 support in mainline GCC SVN, not in any particular release.

1.2 License

There are two licenses affecting GNU libstdc++: one for the code, and one for the documentation.

There is a license section in the FAQ regarding common [questions](#). If you have more questions, ask the FSF or the [gcc mailing list](#).

1.2.1 The Code: GPL

The source code is distributed under the [GNU General Public License version 3](#), with the addition under section 7 of an exception described in the "GCC Runtime Library Exception, version 3.1" as follows (or see the file COPYING.RUNTIME):

```
GCC RUNTIME LIBRARY EXCEPTION
```

```
Version 3.1, 31 March 2009
```

```
Copyright (C) 2009 Free Software Foundation, Inc.
```

```
Everyone is permitted to copy and distribute verbatim copies of this license document, but changing it is not allowed.
```

```
This GCC Runtime Library Exception ("Exception") is an additional permission under section 7 of the GNU General Public License, version 3 ("GPLv3"). It applies to a given file (the "Runtime Library") that bears a notice placed by the copyright holder of the file stating that the file is governed by GPLv3 along with this Exception.
```

```
When you use GCC to compile a program, GCC may combine portions of certain GCC header files and runtime libraries with the compiled program. The purpose of this Exception is to allow compilation of non-GPL (including proprietary) programs to use, in this way, the header files and runtime libraries covered by this Exception.
```

```
0. Definitions.
```

```
A file is an "Independent Module" if it either requires the Runtime Library for execution after a Compilation Process, or makes use of an interface provided by the Runtime Library, but is not otherwise based on the Runtime Library.
```

```
"GCC" means a version of the GNU Compiler Collection, with or without modifications, governed by version 3 (or a specified later version) of
```

Section	Description	Status	Comments
0	<i>Introduction</i>		
1	<i>Normative references</i>		
2	<i>Conventions</i>		
3	<i>Decimal floating-point types</i>		
3.1	Characteristics of decimal floating-point types		
3.2	Decimal Types		
3.2.1	Class <code>decimal</code> synopsis	Partial	Missing declarations for formatted input/output; non-conforming extension for functions converting to integral type
3.2.2	Class <code>decimal32</code>	Partial	Missing 3.2.2.5 conversion to integral type; conforming extension for conversion from scalar decimal floating-point
3.2.3	Class <code>decimal64</code>	Partial	Missing 3.2.3.5 conversion to integral type; conforming extension for conversion from scalar decimal floating-point
3.2.4	Class <code>decimal128</code>	Partial	Missing 3.2.4.5 conversion to integral type; conforming extension for conversion from scalar decimal floating-point
3.2.5	Initialization from coefficient and exponent	Y	
3.2.6	Conversion to generic floating-point type	Y	
3.2.7	Unary arithmetic operators	Y	
3.2.8	Binary arithmetic operators	Y	
3.2.9	Comparison operators	Y	
3.2.10	Formatted input	N	
3.2.11	Formatted output	N	
3.3	Additions to header <code>limits</code>	N	
3.4	Headers <code>cfloat</code> and <code>float.h</code>		
3.4.2	Additions to header <code>cfloat</code> synopsis	Y	
3.4.3	Additions to header <code>float.h</code> synopsis	N	
3.4.4	Maximum finite value	Y	
3.4.5	Epsilon	Y	
3.4.6	Minimum positive normal value	Y	
3.4.7	Minimum positive subnormal value	Y	
3.4.8	Evaluation format	Y	
3.5	Additions to <code>cfloat</code> and <code>float.h</code>	Outside the scope of GCC	
3.6	Additions to <code>cmath</code> and <code>math.h</code>	Outside the scope of GCC	
3.7	Additions to <code>cstdio</code> and <code>stdio.h</code>	Outside the scope of GCC	
3.8	Additions to <code>cstdlib</code> and <code>stdlib.h</code>	Outside the scope of GCC	
3.9	Additions to <code>cwchar</code> and <code>wchar.h</code>	Outside the scope of GCC	
3.10	Facets	N	
3.11	Type traits	N	

the GNU General Public License (GPL) with the option of using any subsequent versions published by the FSF.

"GPL-compatible Software" is software whose conditions of propagation, modification and use would permit combination with GCC in accord with the license of GCC.

"Target Code" refers to output from any compiler for a real or virtual target processor architecture, in executable form or suitable for input to an assembler, loader, linker and/or execution phase. Notwithstanding that, Target Code does not include data in any format that is used as a compiler intermediate representation, or used for producing a compiler intermediate representation.

The "Compilation Process" transforms code entirely represented in non-intermediate languages designed for human-written code, and/or in Java Virtual Machine byte code, into Target Code. Thus, for example, use of source code generators and preprocessors need not be considered part of the Compilation Process, since the Compilation Process can be understood as starting with the output of the generators or preprocessors.

A Compilation Process is "Eligible" if it is done using GCC, alone or with other GPL-compatible software, or if it is done without using any work based on GCC. For example, using non-GPL-compatible Software to optimize any GCC intermediate representations would not qualify as an Eligible Compilation Process.

1. Grant of Additional Permission.

You have permission to propagate a work of Target Code formed by combining the Runtime Library with Independent Modules, even if such propagation would otherwise violate the terms of GPLv3, provided that all Target Code was generated by Eligible Compilation Processes. You may then convey such a combination under terms of your choice, consistent with the licensing of the Independent Modules.

2. No Weakening of GCC Copyleft.

The availability of this Exception does not imply any general presumption that third-party software is unaffected by the copyleft requirements of the license of GCC.

Hopefully that text is self-explanatory. If it isn't, you need to speak to your lawyer, or the Free Software Foundation.

1.2.2 The Documentation: GPL, FDL

The documentation shipped with the library and made available over the web, excluding the pages generated from source comments, are copyrighted by the Free Software Foundation, and placed under the [GNU Free Documentation License version 1.3](#). There are no Front-Cover Texts, no Back-Cover Texts, and no Invariant Sections.

For documentation generated by doxygen or other automated tools via processing source code comments and markup, the original source code license applies to the generated files. Thus, the doxygen documents are licensed [GPL](#).

If you plan on making copies of the documentation, please let us know. We can probably offer suggestions.

1.3 Bugs

1.3.1 Implementation Bugs

Information on known bugs, details on efforts to fix them, and fixed bugs are all available as part of the [GCC bug tracking system](#), with the category set to `libstdc++`.

1.3.2 Standard Bugs

Everybody's got issues. Even the C++ Standard Library.

The Library Working Group, or LWG, is the ISO subcommittee responsible for making changes to the library. They periodically publish an Issues List containing problems and possible solutions. As they reach a consensus on proposed solutions, we often incorporate the solution.

Here are the issues which have resulted in code changes to the library. The links are to the specific defect reports from a *partial copy* of the Issues List. You can read the full version online at the [ISO C++ Committee homepage](#), linked to on the [GCC "Readings" page](#). If you spend a lot of time reading the issues, we recommend downloading the ZIP file and reading them locally.

(NB: *partial copy* means that not all links within the `lwg-*.html` pages will work. Specifically, links to defect reports that have not been accorded full DR status will probably break. Rather than trying to mirror the entire issues list on our overworked web server, we recommend you go to the LWG homepage instead.)

If a DR is not listed here, we may simply not have gotten to it yet; feel free to submit a patch. Search the `include/bits` and `src` directories for appearances of `_GLIBCXX_RESOLVE_LIB_DEFECTS` for examples of style. Note that we usually do not make changes to the code until an issue has reached **DR** status.

- 5: *string::compare specification questionable*** This should be two overloaded functions rather than a single function.
- 17: *Bad bool parsing*** Apparently extracting Boolean values was messed up...
- 19: *"Noconv" definition too vague*** If `codecvt::do_in` returns `noconv` there are no changes to the values in `[to, to_limit)`.
- 22: *Member open vs flags*** Re-opening a file stream does *not* clear the state flags.
- 23: *Num_get overflow result*** Implement the proposed resolution.
- 25: *String operator<< uses width() value wrong*** Padding issues.
- 48: *Use of non-existent exception constructor*** An instance of `ios_base::failure` is constructed instead.
- 49: *Underspecification of ios_base::sync_with_stdio*** The return type is the *previous* state of synchronization.
- 50: *Copy constructor and assignment operator of ios_base*** These members functions are declared `private` and are thus inaccessible. Specifying the correct semantics of "copying stream state" was deemed too complicated.
- 60: *What is a formatted input function?*** This DR made many widespread changes to `basic_istream` and `basic_ostream` all of which have been implemented.
- 63: *Exception-handling policy for unformatted output*** Make the policy consistent with that of formatted input, unformatted input, and formatted output.
- 68: *Extractors for char* should store null at end*** And they do now. An editing glitch in the last item in the list of [27.6.1.2.3]/7.
- 74: *Garbled text for codecvt::do_max_length*** The text of the standard was gibberish. Typos gone rampant.
- 75: *Contradiction in codecvt::length's argument types*** Change the first parameter to `stateT&` and implement the new effects paragraph.

- 83: *string::npos* vs. *string::max_size()*** Safety checks on the size of the string should test against `max_size()` rather than `npos`.
- 90: *Incorrect description of operator>> for strings*** The effect contain `isspace(c, getloc())` which must be replaced by `isspace(c, is.getloc())`.
- 91: *Description of operator>> and getline() for string<> might cause endless loop*** They behave as a formatted input function and as an unformatted input function, respectively (except that `getline` is not required to set `gcount`).
- 103: *set::iterator is required to be modifiable, but this allows modification of keys.*** For associative containers where the value type is the same as the key type, both `iterator` and `const_iterator` are constant iterators.
- 109: *Missing binders for non-const sequence elements*** The `binder1st` and `binder2nd` didn't have an `operator()` taking a non-const parameter.
- 110: *istreambuf_iterator::equal not const*** This was not a const member function. Note that the DR says to replace the function with a const one; we have instead provided an overloaded version with identical contents.
- 117: *basic_ostream uses nonexistent num_put member functions*** `num_put::put()` was overloaded on the wrong types.
- 118: *basic_istream uses nonexistent num_get member functions*** Same as 117, but for `num_get::get()`.
- 129: *Need error indication from seekp() and seekg()*** These functions set `failbit` on error now.
- 130: *Return type of container::erase(iterator) differs for associative containers*** Make member `erase` return iterator for `set`, `multiset`, `map`, `multimap`.
- 136: *seekp, seekg setting wrong streams?*** `seekp` should only set the output stream, and `seekg` should only set the input stream.
- 167: *Improper use of traits_type::length()*** `op<<` with a `const char*` was calculating an incorrect number of characters to write.
- 169: *Bad efficiency of overflow() mandated*** Grow efficiently the internal array object.
- 171: *Strange seekpos() semantics due to joint position*** Quite complex to summarize...
- 181: *make_pair() unintended behavior*** This function used to take its arguments as reference-to-const, now it copies them (pass by value).
- 195: *Should basic_istream::sentry's constructor ever set eofbit?*** Yes, it can, specifically if EOF is reached while skipping whitespace.
- 211: *operator>>(istream&, string&) doesn't set failbit*** If nothing is extracted into the string, `op>>` now sets `failbit` (which can cause an exception, etc., etc.).
- 214: *set::find() missing const overload*** Both `set` and `multiset` were missing overloaded `find`, `lower_bound`, `upper_bound`, and `equal_range` functions for const instances.
- 231: *Precision in iostream?*** For conversion from a floating-point type, `str.precision()` is specified in the conversion specification.
- 233: *Insertion hints in associative containers*** Implement N1780, first check before then check after, insert as close to hint as possible.
- 235: *No specification of default ctor for reverse_iterator*** The declaration of `reverse_iterator` lists a default constructor. However, no specification is given what this constructor should do.
- 241: *Does unique_copy() require CopyConstructible and Assignable?*** Add a helper for `forward_iterator/output_iterator`, fix the existing one for `input_iterator/output_iterator` to not rely on Assignability.
- 243: *get and getline when sentry reports failure*** Store a null character only if the character array has a non-zero size.
- 251: *basic_stringbuf missing allocator_type*** This nested typedef was originally not specified.

- 253: *valarray helper functions are almost entirely useless*** Make the copy constructor and copy-assignment operator declarations public in `gslice_array`, `indirect_array`, `mask_array`, `slice_array`; provide definitions.
- 265: *std::pair::pair() effects overly restrictive*** The default ctor would build its members from copies of temporaries; now it simply uses their respective default ctors.
- 266: *bad_exception::~bad_exception() missing Effects clause*** The `bad_*` classes no longer have destructors (they are trivial), since no description of them was ever given.
- 271: *basic_iostream missing typedefs*** The typedefs it inherits from its base classes can't be used, since (for example) `basic_iostream<T>::traits_type` is ambiguous.
- 275: *Wrong type in num_get::get() overloads*** Similar to 118.
- 280: *Comparison of reverse_iterator to const reverse_iterator*** Add global functions with two template parameters. (NB: not added for now a templated assignment operator)
- 292: *Effects of a.copypmt(a)*** If `(this ==&rhs)` do nothing.
- 300: *List::merge() specification incomplete*** If `(this ==&x)` do nothing.
- 303: *Bitset input operator underspecified*** Basically, compare the input character to `is.widen(0)` and `is.widen(1)`.
- 305: *Default behavior of codecvt<wchar_t, char, mbstate_t>::length()*** Do not specify what `codecvt<wchar_t, char, mbstate_t>::do_length` must return.
- 328: *Bad sprintf format modifier in money_put<>::do_put()*** Change the format string to `"%.0Lf"`.
- 365: *Lack of const-qualification in clause 27*** Add `const` overloads of `is_open`.
- 387: *std::complex over-encapsulated*** Add the `real(T)` and `imag(T)` members; in C++11 mode, also adjust the existing `real()` and `imag()` members and free functions.
- 389: *Const overload of valarray::operator[] returns by value*** Change it to return a `const T&`.
- 396: *what are characters zero and one*** Implement the proposed resolution.
- 402: *Wrong new expression in [some_]allocator::construct*** Replace "new" with `::new`.
- 408: *Is vector<reverse_iterator<char*>> forbidden?*** Tweak the debug-mode checks in `_Safe_iterator`.
- 409: *Closing an fstream should clear the error state*** Have `open` clear the error flags.
- 431: *Swapping containers with unequal allocators*** Implement Option 3, as per N1599.
- 432: *stringbuf::overflow() makes only one write position available*** Implement the resolution, beyond DR 169.
- 434: *bitset::to_string() hard to use*** Add three overloads, taking fewer template arguments.
- 438: *Ambiguity in the "do the right thing" clause*** Implement the resolution, basically cast less.
- 453: *basic_stringbuf::seekoff need not always fail for an empty stream*** Don't fail if the next pointer is null and `newoff` is zero.
- 455: *cerr::tie() and wcerr::tie() are overspecified*** Initialize `cerr` tied to `cout` and `wcerr` tied to `wcout`.
- 464: *Suggestion for new member functions in standard containers*** Add `data()` to `std::vector` and `at(const key_type&)` to `std::map`.
- 508: *Bad parameters for ranlux64_base_01*** Fix the parameters.
- 512: *Seeding subtract_with_carry_01 from a single unsigned long*** Construct a `linear_congruential` engine and seed with it.
- 526: *Is it undefined if a function in the standard changes in parameters?*** Use `&value`.
- 538: *241 again: Does unique_copy() require CopyConstructible and Assignable?*** In case of `input_iterator/output_iterator` rely on Assignability of `input_iterator::value_type`.

- 539:** *partial_sum and adjacent_difference should mention requirements* We were almost doing the right thing, just use `std::move` in `adjacent_difference`.
- 541:** *shared_ptr template assignment and void* Add an `auto_ptr<void>` specialization.
- 543:** *valarray slice default constructor* Follow the straightforward proposed resolution.
- 550:** *What should the return type of pow(float,int) be?* In C++11 mode, remove the `pow(float,int)`, etc., signatures.
- 586:** *string inserter not a formatted function* Change it to be a formatted output function (i.e. catch exceptions).
- 596:** *27.8.1.3 Table 112 omits "a+" and "a+b" modes* Add the missing modes to `fopen_mode`.
- 630:** *arrays of valarray* Implement the simple resolution.
- 660:** *Missing bitwise operations* Add the missing operations.
- 691:** *const_local_iterator cbegin, cend missing from TRI* In C++11 mode add `cbegin(size_type)` and `cend(size_type)` to the unordered containers.
- 693:** *std::bitset::all() missing* Add it, consistently with the discussion.
- 695:** *ctype<char>::classic_table() not accessible* Make the member functions `table` and `classic_table` public.
- 696:** *istream::operator>>(int&) broken* Implement the straightforward resolution.
- 761:** *unordered_map needs an at() member function* In C++11 mode, add `at()` and `at() const`.
- 775:** *Tuple indexing should be unsigned?* Implement the `int -> size_t` replacements.
- 776:** *Undescribed assign function of std::array* In C++11 mode, remove `assign`, add `fill`.
- 781:** *std::complex should add missing C99 functions* In C++11 mode, add `std::proj`.
- 809:** *std::swap should be overloaded for array types* Add the overload.
- 853:** *to_string needs updating with zero and one* Update / add the signatures.
- 865:** *More algorithms that throw away information* The traditional HP / SGI return type and value is blessed by the resolution of the DR.
-

Chapter 2

Setup

To transform libstdc++ sources into installed include files and properly built binaries useful for linking to other software is a multi-step process. Steps include getting the sources, configuring and building the sources, testing, and installation.

The general outline of commands is something like:

```
get gcc sources
extract into gccsrcdir
mkdir gccbuilddir
cd gccbuilddir
gccsrcdir/configure --prefix=destdir --other-opts...
make
make check
make install
```

Each step is described in more detail in the following sections.

2.1 Prerequisites

Because libstdc++ is part of GCC, the primary source for installation instructions is [the GCC install page](#). In particular, list of prerequisite software needed to build the library [starts with those requirements](#). The same pages also list the tools you will need if you wish to modify the source.

Additional data is given here only where it applies to libstdc++.

As of GCC 4.0.1 the minimum version of binutils required to build libstdc++ is 2.15.90.0.1.1. Older releases of libstdc++ do not require such a recent version, but to take full advantage of useful space-saving features and bug-fixes you should use a recent binutils whenever possible. The configure process will automatically detect and use these features if the underlying support is present.

To generate the API documentation from the sources you will need Doxygen, see [Documentation Hacking](#) in the appendix for full details.

Finally, a few system-specific requirements:

linux If GCC 3.1.0 or later on is being used on GNU/Linux, an attempt will be made to use "C" library functionality necessary for C++ named locale support. For GCC 4.6.0 and later, this means that glibc 2.3 or later is required.

If the 'gnu' locale model is being used, the following locales are used and tested in the libstdc++ testsuites. The first column is the name of the locale, the second is the character set it is expected to use.

de_DE	ISO-8859-1
de_DE@euro	ISO-8859-15
en_GB	ISO-8859-1

en_HK	ISO-8859-1
en_PH	ISO-8859-1
en_US	ISO-8859-1
en_US.ISO-8859-1	ISO-8859-1
en_US.ISO-8859-15	ISO-8859-15
en_US.UTF-8	UTF-8
es_ES	ISO-8859-1
es_MX	ISO-8859-1
fr_FR	ISO-8859-1
fr_FR@euro	ISO-8859-15
is_IS	UTF-8
it_IT	ISO-8859-1
ja_JP.eucjp	EUC-JP
ru_RU.ISO-8859-5	ISO-8859-5
ru_RU.UTF-8	UTF-8
se_NO.UTF-8	UTF-8
ta_IN	UTF-8
zh_TW	BIG5

Failure to have installed the underlying "C" library locale information for any of the above regions means that the corresponding C++ named locale will not work: because of this, the libstdc++ test suite will skip named locale tests which need missing information. If this isn't an issue, don't worry about it. If a named locale is needed, the underlying locale information must be installed. Note that rebuilding libstdc++ after "C" locales are installed is not necessary.

To install support for locales, do only one of the following:

- install all locales
- install just the necessary locales
 - with Debian GNU/Linux:
 - Add the above list, as shown, to the file `/etc/locale.gen`
 - run `/usr/sbin/locale-gen`
 - on most Unix-like operating systems:
 - `localedef -i de_DE -f ISO-8859-1 de_DE`
 - (repeat for each entry in the above list)
 - Instructions for other operating systems solicited.

2.2 Configure

When configuring libstdc++, you'll have to configure the entire `gccsrcdir` directory. Consider using the toplevel gcc configuration option `--enable-languages=c++`, which saves time by only building the C++ toolchain.

Here are all of the configure options specific to libstdc++. Keep in mind that **they all have opposite forms as well** (enable/disable and with/without). The defaults are for the *current development sources*, which may be different than those for released versions.

The canonical way to find out the configure options that are available for a given set of libstdc++ sources is to go to the source directory and then type: `./configure --help`.

--enable-multilib[default] This is part of the generic multilib support for building cross compilers. As such, targets like "powerpc-elf" will have libstdc++ built many different ways: "-msoft-float" and not, etc. A different libstdc++ will be built for each of the different multilib versions. This option is on by default.

--enable-sjlj-exceptions Forces old, set-jump/long-jump exception handling model. If at all possible, the new, frame unwinding exception handling routines should be used instead, as they significantly reduce both runtime memory usage and executable size. This option can change the library ABI.

--enable-version-specific-runtime-libs Specify that run-time libraries should be installed in the compiler-specific subdirectory (i.e., `${libdir}/gcc-lib/${target_alias}/${gcc_version}`) instead of `${libdir}`. This option is useful if you intend to use several versions of gcc in parallel. In addition, libstdc++'s include files will be installed in `${libdir}/gcc-lib/${target_alias}/${gcc_version}/include/g++`, unless you also specify `--with-gxx-include-dir=dirname` during configuration.

--with-gxx-include-dir=<include-files dir> Adds support for named libstdc++ include directory. For instance, the following puts all the libstdc++ headers into a directory called "4.4-20090404" instead of the usual "c++/(version)".

```
--with-gxx-include-dir=/foo/H-x86-gcc-3-c-gxx-inc/include/4.4-20090404
```

--enable-cstdio This is an abbreviated form of '`--enable-cstdio=stdio`' (described next).

--enable-cstdio=OPTION Select a target-specific I/O package. At the moment, the only choice is to use 'stdio', a generic "C" abstraction. The default is 'stdio'. This option can change the library ABI.

--enable-clocale This is an abbreviated form of '`--enable-clocale=generic`' (described next).

--enable-clocale=OPTION Select a target-specific underlying locale package. The choices are 'ieee_1003.1-2001' to specify an X/Open, Standard Unix (IEEE Std. 1003.1-2001) model based on langinfo/iconv/catgets, 'gnu' to specify a model based on functionality from the GNU C library (langinfo/iconv/gettext) (from [glibc](#), the GNU C library), 'generic' to use a generic "C" abstraction which consists of "C" locale info, 'newlib' to specify the Newlib C library model which only differs from the 'generic' model in the handling of ctype, or 'darwin' which omits the wchar_t specializations needed by the 'generic' model.

If not explicitly specified, the configure process tries to guess the most suitable package from the choices above. The default is 'generic'. On glibc-based systems of sufficient vintage (2.3 and newer), 'gnu' is automatically selected. On newlib-based systems (`--with_newlib=yes`) and OpenBSD, 'newlib' is automatically selected. On Mac OS X 'darwin' is automatically selected. This option can change the library ABI.

--enable-libstdcxx-allocator This is an abbreviated form of '`--enable-libstdcxx-allocator=auto`' (described next).

--enable-libstdcxx-allocator=OPTION Select a target-specific underlying std::allocator. The choices are 'new' to specify a wrapper for new, 'malloc' to specify a wrapper for malloc, 'mt' for a fixed power of two allocator, 'pool' for the SGI pooled allocator or 'bitmap' for a bitmap allocator. See this page for more information on allocator [extensions](#). This option can change the library ABI.

--enable-headers=OPTION This allows the user to define the approach taken for C header compatibility with C++. Options are c, c_std, and c_global. These correspond to the source directory's include/c, include/c_std, and include/c_global, and may also include include/c_compatibility. The default is 'c_global'.

--enable-threads This is an abbreviated form of '`--enable-threads=yes`' (described next).

--enable-threads=OPTION Select a threading library. A full description is given in the general [compiler configuration instructions](#). This option can change the library ABI.

--enable-libstdcxx-threads Enable C++11 threads support. If not explicitly specified, the configure process enables it if possible. It defaults to 'off' on Solaris 9, where it would break symbol versioning. This option can change the library ABI.

--enable-libstdcxx-time This is an abbreviated form of '`--enable-libstdcxx-time=yes`' (described next).

--enable-libstdcxx-time=OPTION Enables link-type checks for the availability of the clock_gettime clocks, used in the implementation of [time.clock], and of the nanosleep and sched_yield functions, used in the implementation of [thread.thread.this] of the 2011 ISO C++ standard. The choice OPTION=yes checks for the availability of the facilities in libc and libposix4. In case it's needed the latter is also linked to libstdc++ as part of the build process. OPTION=rt also searches (and, if needed, links) librt. Note that the latter is not always desirable because, in glibc, for example, in turn it triggers the linking of libpthread too, which activates locking, a large overhead for single-thread programs. OPTION=no skips the tests completely. The default is OPTION=no.

--enable-libstdcxx-debug Build separate debug libraries in addition to what is normally built. By default, the debug libraries are compiled with `CXXFLAGS='-g3 -O0 -fno-inline'`, are installed in `${libdir}/debug`, and have the same names and versioning information as the non-debug libraries. This option is off by default.

Note this make command, executed in the build directory, will do much the same thing, without the configuration difference and without building everything twice: `make CXXFLAGS='-g3 -O0 -fno-inline' all`

--enable-libstdcxx-debug-flags=FLAGS This option is only valid when `--enable-debug` is also specified, and applies to the debug builds only. With this option, you can pass a specific string of flags to the compiler to use when building the debug versions of libstdc++. `FLAGS` is a quoted string of options, like

```
--enable-libstdcxx-debug-flags='-g3 -O1 -fno-inline'
```

--enable-cxx-flags=FLAGS With this option, you can pass a string of `-f` (functionality) flags to the compiler to use when building libstdc++. This option can change the library ABI. `FLAGS` is a quoted string of options, like

```
--enable-cxx-flags='-fvtable-gc -fomit-frame-pointer -ansi'
```

Note that the flags don't necessarily have to all be `-f` flags, as shown, but usually those are the ones that will make sense for experimentation and configure-time overriding.

The advantage of `--enable-cxx-flags` over setting `CXXFLAGS` in the 'make' environment is that, if files are automatically rebuilt, the same flags will be used when compiling those files as well, so that everything matches.

Fun flags to try might include combinations of

```
-fstrict-aliasing
-fno-exceptions
-ffunction-sections
-fvtable-gc
```

and opposite forms (`-fno-`) of the same. Tell us (the libstdc++ mailing list) if you discover more!

--enable-c99 The long long type was introduced in C99, along with many other functions for wide characters, and math classification macros, etc. If enabled, all C99 functions not specified by the C++ standard will be put into namespace `__gnu_cxx`, and then all these names will be injected into namespace `std`, so that C99 functions can be used "as if" they were in the C++ standard (as they will eventually be in some future revision of the standard, without a doubt). By default, C99 support is on, assuming the configure probes find all the necessary functions and bits necessary. This option can change the library ABI.

--enable-wchar_t[default] Template specializations for the `wchar_t` type are required for wide character conversion support. Disabling wide character specializations may be expedient for initial porting efforts, but builds only a subset of what is required by ISO, and is not recommended. By default, this option is on. This option can change the library ABI.

--enable-long-long The long long type was introduced in C99. It is provided as a GNU extension to C++98 in `g++`. This flag builds support for "long long" into the library (specialized templates and the like for `iostreams`). This option is on by default: if enabled, users will have to either use the new-style "C" headers by default (i.e., `<cmath>` not `<math.h>`) or add appropriate compile-time flags to all compile lines to allow "C" visibility of this feature (on GNU/Linux, the flag is `-D_ISOC99_SOURCE`, which is added automatically via `CPLUSPLUS_CPP_SPEC`'s addition of `_GNU_SOURCE`). This option can change the library ABI.

--enable-fully-dynamic-string This option enables a special version of `basic_string` avoiding the optimization that allocates empty objects in static memory. Mostly useful together with shared memory allocators, see PR libstdc++/16612 for details.

--enable-concept-checks This turns on additional compile-time checks for instantiated library templates, in the form of specialized templates, [described here](#). They can help users discover when they break the rules of the STL, before their programs run.

--enable-symvers[=style] In 3.1 and later, tries to turn on symbol versioning in the shared library (if a shared library has been requested). Values for 'style' that are currently supported are 'gnu', 'gnu-versioned-namespace', 'darwin', 'darwin-export', and 'sun'. Both `gnu-` options require that a recent version of the GNU linker be in use. Both `darwin` options are equivalent. With no style given, the configure script will try to guess correct defaults for the host system, probe to see if additional requirements are necessary and present for activation, and if so, will turn symbol versioning on. This option can change the library ABI.

--enable-libstdcxx-visibility In 4.2 and later, enables or disables visibility attributes. If enabled (as by default), and the compiler seems capable of passing the simple sanity checks thrown at it, adjusts items in namespace `std`, namespace `std::tr1`, namespace `std::tr2`, and namespace `__gnu_cxx` to have `visibility` ("default") so that `-fvisibility` options can be used without affecting the normal external-visibility of namespace `std` entities. Prior to 4.7 this option was spelled `--enable-visibility`.

- enable-libstdcxx-pch** In 3.4 and later, tries to turn on the generation of `stdc++.h.gch`, a pre-compiled file including all the standard C++ includes. If enabled (as by default), and the compiler seems capable of passing the simple sanity checks thrown at it, try to build `stdc++.h.gch` as part of the make process. In addition, this generated file is used later on (by appending `--include bits/stdc++.h` to `CXXFLAGS`) when running the testsuite.
- enable-extern-template[default]** Use extern template to pre-instantiate all required specializations for certain types defined in the standard libraries. These types include `string` and dependents like `char_traits`, the templated IO classes, `allocator`, and others. Disabling means that implicit template generation will be used when compiling these types. By default, this option is on. This option can change the library ABI.
- disable-hosted-libstdcxx** By default, a complete *hosted* C++ library is built. The C++ Standard also describes a *freestanding* environment, in which only a minimal set of headers are provided. This option builds such an environment.
- disable-libstdcxx-verbose** By default, the library is configured to write descriptive messages to standard error for certain events such as calling a pure virtual function or the invocation of the standard terminate handler. Those messages cause the library to depend on the demangler and standard I/O facilities, which might be undesirable in a low-memory environment or when standard error is not available. This option disables those messages. This option does not change the library ABI.
- enable-vtable-verify[default]** Use `-fvtable-verify=std` to compile the C++ runtime with instrumentation for vtable verification. All virtual functions in the standard library will be verified at runtime. Types impacted include `locale` and `iostream`, and others. Disabling means that the C++ runtime is compiled without support for vtable verification. By default, this option is off.

2.3 Make

If you have never done this before, you should read the basic [GCC Installation Instructions](#) first. Read *all of them. Twice.*

Then type: **make**, and congratulations, you've started to build.

Chapter 3

Using

3.1 Command Options

The set of features available in the GNU C++ library is shaped by several [GCC Command Options](#). Options that impact libstdc++ are enumerated and detailed in the table below.

By default, `g++` is equivalent to `g++ -std=gnu++98`. The standard library also defaults to this dialect.

Option Flags	Description
<code>-std=c++98</code>	Use the 1998 ISO C++ standard plus amendments.
<code>-std=gnu++98</code>	As directly above, with GNU extensions.
<code>-std=c++11</code>	Use the 2011 ISO C++ standard.
<code>-std=gnu++11</code>	As directly above, with GNU extensions.
<code>-fexceptions</code>	See exception-free dialect
<code>-frtti</code>	As above, but RTTI-free dialect.
<code>-pthread</code> or <code>-pthreads</code>	For ISO C++11 <code><thread></code> , <code><future></code> , <code><mutex></code> , or <code><condition_variable></code> .
<code>-fopenmp</code>	For parallel mode.

Table 3.1: C++ Command Options

3.2 Headers

3.2.1 Header Files

The C++ standard specifies the entire set of header files that must be available to all hosted implementations. Actually, the word "files" is a misnomer, since the contents of the headers don't necessarily have to be in any kind of external file. The only rule is that when one `#include`'s a header, the contents of that header become available, no matter how.

That said, in practice files are used.

There are two main types of include files: header files related to a specific version of the ISO C++ standard (called Standard Headers), and all others (TR1, C++ ABI, and Extensions).

Two dialects of standard headers are supported, corresponding to the 1998 standard as updated for 2003, and the current 2011 standard.

C++98/03 include files. These are available in the default compilation mode, i.e. `-std=c++98` or `-std=gnu++98`.

C++11 include files. These are only available in C++11 compilation mode, i.e. `-std=c++11` or `-std=gnu++11`.

algorithm	bitset	complex	deque	exception
fstream	functional	iomanip	ios	iosfwd
iostream	istream	iterator	limits	list
locale	map	memory	new	numeric
ostream	queue	set	sstream	stack
stdexcept	streambuf	string	utility	typeinfo
valarray	vector			

Table 3.2: C++ 1998 Library Headers

cassert	cerrno	cctype	cfloat	ciso646
climits	locale	cmath	csetjmp	csignal
cstdarg	cstddef	cstdio	cstdlib	cstring
ctime	wchar	ctype		

Table 3.3: C++ 1998 Library Headers for C Library Facilities

algorithm	array	bitset	chrono	complex
condition_variable	deque	exception	forward_list	fstream
functional	future	initializer_list	iomanip	ios
iosfwd	iostream	istream	iterator	limits
list	locale	map	memory	mutex
new	numeric	ostream	queue	random
ratio	regex	set	sstream	stack
stdexcept	streambuf	string	system_error	thread
tuple	type_traits	typeinfo	unordered_map	unordered_set
utility	valarray	vector		

Table 3.4: C++ 2011 Library Headers

cassert	ccomplex	cctype	cerrno	cfenv
cfloat	cinttypes	ciso646	climits	locale
cmath	csetjmp	csignal	cstdarg	cstdbool
cstddef	cstdint	cstdlib	cstdio	cstring
ctgmth	ctime	cuchar	wchar	ctype

Table 3.5: C++ 2011 Library Headers for C Library Facilities

tr1/array	tr1/complex	tr1/memory	tr1/functional	tr1/random
tr1/regex	tr1/tuple	tr1/type_traits	tr1/unordered_map	tr1/unordered_set
tr1/utility				

Table 3.6: C++ TR 1 Library Headers

tr1/ccomplex	tr1/cfenv	tr1/cfloat	tr1/cmath	tr1/cinttypes
tr1/climits	tr1/cstdarg	tr1/cstdbool	tr1/cstdint	tr1/cstdio
tr1/cstdlib	tr1/ctgmth	tr1/ctime	tr1/wchar	tr1/ctype

Table 3.7: C++ TR 1 Library Headers for C Library Facilities

In addition, TR1 includes as:

Decimal floating-point arithmetic is available if the C++ compiler supports scalar decimal floating-point types defined via `__attribute__((mode(SD|DD|LD)))`.

decimal/decimal

Table 3.8: C++ TR 24733 Decimal Floating-Point Header

Also included are files for the C++ ABI interface:

cxxabi.h	cxxabi_forced.h
----------	-----------------

Table 3.9: C++ ABI Headers

And a large variety of extensions.

ext/algorithm	ext/atomicity.h	ext/array_allocator.h	ext/bitmap_allocator.h	ext/cast.h
ext/codecv_t_specializations.h	ext/concurrence.h	ext/debug_allocator.h	ext/enc_filebuf.h	ext/extptr_allocator.h
ext/functional	ext/iterator	ext/malloc_allocator.h	ext/memory	ext/mt_allocator.h
ext/new_allocator.h	ext/numeric	ext/numeric_traits.h	ext/pb_ds/assoc_container.h	ext/pb_ds/priority_queue.h
ext/pod_char_traits.h	ext/pool_allocator.h	ext/rb_tree	ext/rope	ext/slist
ext/stdio_filebuf.h	ext/stdio_sync_filebuf.h	ext/throw_allocator.h	ext/typelist.h	ext/type_traits.h
ext/vstring.h				

Table 3.10: Extension Headers

3.2.2 Mixing Headers

A few simple rules.

First, mixing different dialects of the standard headers is not possible. It's an all-or-nothing affair. Thus, code like

```
#include <array>
#include <functional>
```

Implies C++11 mode. To use the entities in `<array>`, the C++11 compilation mode must be used, which implies the C++11 functionality (and deprecations) in `<functional>` will be present.

Second, the other headers can be included with either dialect of the standard headers, although features and types specific to C++11 are still only enabled when in C++11 compilation mode. So, to use rvalue references with `__gnu_cxx::vstring`, or to use the debug-mode versions of `std::unordered_map`, one must use the `std=gnu++11` compiler flag. (Or `std=c++11`, of course.)

A special case of the second rule is the mixing of TR1 and C++11 facilities. It is possible (although not especially prudent) to include both the TR1 version and the C++11 version of header in the same translation unit:

```
#include <tr1/type_traits>
#include <type_traits>
```

Several parts of C++11 diverge quite substantially from TR1 predecessors.

debug/bitset	debug/deque	debug/list	debug/map	debug/set
debug/string	debug/ unordered_map	debug/ unordered_set	debug/vector	

Table 3.11: Extension Debug Headers

profile/bitset	profile/deque	profile/list	profile/map
profile/set	profile/unordered_ map	profile/unordered_ set	profile/vector

Table 3.12: Extension Profile Headers

3.2.3 The C Headers and namespace `std`

The standard specifies that if one includes the C-style header (`<math.h>` in this case), the symbols will be available in the global namespace and perhaps in namespace `std::` (but this is no longer a firm requirement.) On the other hand, including the C++-style header (`<cmath>`) guarantees that the entities will be found in namespace `std` and perhaps in the global namespace.

Usage of C++-style headers is recommended, as then C-linkage names can be disambiguated by explicit qualification, such as by `std::abort`. In addition, the C++-style headers can use function overloading to provide a simpler interface to certain families of C-functions. For instance in `<cmath>`, the function `std::sin` has overloads for all the builtin floating-point types. This means that `std::sin` can be used uniformly, instead of a combination of `std::sinf`, `std::sin`, and `std::sinl`.

3.2.4 Precompiled Headers

There are three base header files that are provided. They can be used to precompile the standard headers and extensions into binary files that may be used to speed compiles that use these headers.

- `stdc++.h`
Includes all standard headers. Actual content varies depending on language dialect.
- `stdtr1c++.h`
Includes all of `<stdc++.h>`, and adds all the TR1 headers.
- `extc++.h`
Includes all of `<stdtr1c++.h>`, and adds all the Extension headers.

How to construct a `.gch` file from one of these base header files.

First, find the include directory for the compiler. One way to do this is:

```
g++ -v hello.cc

#include <...> search starts here:
 /mnt/share/bld/H-x86-gcc.20071201/include/c++/4.3.0
...
End of search list.
```

Then, create a precompiled header file with the same flags that will be used to compile other projects.

parallel/algorithm	parallel/numeric
--------------------	------------------

Table 3.13: Extension Parallel Headers

```
g++ -Winvalid-pch -x c++-header -g -O2 -o ./stdc++.h.gch /mnt/share/bld/H-x86-gcc.20071201/ ←
include/c++/4.3.0/x86_64-unknown-linux-gnu/bits/stdc++.h
```

The resulting file will be quite large: the current size is around thirty megabytes.

How to use the resulting file.

```
g++ -I. -include stdc++.h -H -g -O2 hello.cc
```

Verification that the PCH file is being used is easy:

```
g++ -Winvalid-pch -I. -include stdc++.h -H -g -O2 hello.cc -o test.exe
! ./stdc++.h.gch
. /mnt/share/bld/H-x86-gcc.20071201/include/c++/4.3.0/iostream
. /mnt/share/bld/H-x86-gcc.20071201include/c++/4.3.0/string
```

The exclamation point to the left of the `stdc++.h.gch` listing means that the generated PCH file was used.

Detailed information about creating precompiled header files can be found in the [GCC documentation](#).

3.3 Macros

All library macros begin with `_GLIBCXX_`.

Furthermore, all pre-processor macros, switches, and configuration options are gathered in the file `c++config.h`, which is generated during the `libstdc++` configuration and build process. This file is then included when needed by files part of the public `libstdc++` API, like `<ios>`. Most of these macros should not be used by consumers of `libstdc++`, and are reserved for internal implementation use. *These macros cannot be redefined.*

A select handful of macros control `libstdc++` extensions and extra features, or provide versioning information for the API. Only those macros listed below are offered for consideration by the general public.

Below is the macro which users may check for library version information.

`__GLIBCXX__` The current version of `libstdc++` in compressed ISO date format, form of an unsigned long. For details on the value of this particular macro for a particular release, please consult this [document](#).

Below are the macros which users may change with `#define/#undef` or with `-D/-U` compiler flags. The default state of the symbol is listed.

“Configurable” (or “Not configurable”) means that the symbol is initially chosen (or not) based on `--enable/--disable` options at library build and configure time (documented [here](#)), with the various `--enable/--disable` choices being translated to `#define/#undef`.

ABI means that changing from the default value may mean changing the ABI of compiled code. In other words, these choices control code which has already been compiled (i.e., in a binary such as `libstdc++.a/.so`). If you explicitly `#define` or `#undef` these macros, the *headers* may see different code paths, but the *libraries* which you link against will not. Experimenting with different values with the expectation of consistent linkage requires changing the config headers before building/installing the library.

`__GLIBCXX_USE_DEPRECATED` Defined by default. Not configurable. ABI-changing. Turning this off removes older ARM-style `iostreams` code, and other anachronisms from the API. This macro is dependent on the version of the standard being tracked, and as a result may give different results for `-std=c++98` and `-std=c++11`. This may be useful in updating old C++ code which no longer meet the requirements of the language, or for checking current code against new language standards.

`__GLIBCXX_CONCEPT_CHECKS` Undefined by default. Configurable via `--enable-concept-checks`. When defined, performs compile-time checking on certain template instantiations to detect violations of the requirements of the standard. This is described in more detail [here](#).

`__GLIBCXX_DEBUG` Undefined by default. When defined, compiles user code using the [debug mode](#).

`__GLIBCXX_DEBUG_PEDANTIC` Undefined by default. When defined while compiling with the [debug mode](#), makes the debug mode extremely picky by making the use of libstdc++ extensions and libstdc++-specific behavior into errors.

`__GLIBCXX_PARALLEL` Undefined by default. When defined, compiles user code using the [parallel mode](#).

`__GLIBCXX_PROFILE` Undefined by default. When defined, compiles user code using the [profile mode](#).

3.4 Namespaces

3.4.1 Available Namespaces

There are three main namespaces.

- `std`

The ISO C++ standards specify that "all library entities are defined within namespace `std`." This includes namespaces nested within namespace `std`, such as namespace `std::tr1`.

- `abi`

Specified by the C++ ABI. This ABI specifies a number of type and function APIs supplemental to those required by the ISO C++ Standard, but necessary for interoperability.

- `__gnu__`

Indicating one of several GNU extensions. Choices include `__gnu_cxx`, `__gnu_debug`, `__gnu_parallel`, and `__gnu_pbds`.

A complete list of implementation namespaces (including namespace contents) is available in the generated source [documentation](#).

3.4.2 namespace `std`

One standard requirement is that the library components are defined in namespace `std::`. Thus, in order to use these types or functions, one must do one of two things:

- put a kind of *using-declaration* in your source (either using `namespace std;` or i.e. using `std::string;`) This approach works well for individual source files, but should not be used in a global context, like header files.
- use a *fully qualified name* for each library symbol (i.e. `std::string`, `std::cout`) Always can be used, and usually enhanced, by strategic use of typedefs. (In the cases where the qualified verbiage becomes unwieldy.)

3.4.3 Using Namespace Composition

Best practice in programming suggests sequestering new data or functionality in a sanely-named, unique namespace whenever possible. This is considered an advantage over dumping everything in the global namespace, as then name look-up can be explicitly enabled or disabled as above, symbols are consistently mangled without repetitive naming prefixes or macros, etc.

For instance, consider a project that defines most of its classes in namespace `gtk`. It is possible to adapt namespace `gtk` to namespace `std` by using a C++-feature called *namespace composition*. This is what happens if a *using-declaration* is put into a namespace-definition: the imported symbol(s) gets imported into the currently active namespace(s). For example:

```
namespace gtk
{
    using std::string;
    using std::tr1::array;

    class Window { ... };
}
```

In this example, `std::string` gets imported into namespace `gtk`. The result is that use of `std::string` inside namespace `gtk` can just use `string`, without the explicit qualification. As an added bonus, `std::string` does not get imported into the global namespace. Additionally, a more elaborate arrangement can be made for backwards compatibility and portability, whereby the `using`-declarations can be wrapped in macros that are set based on autoconf-tests to either `""` or i.e. `using std::string;` (depending on whether the system has `libstdc++` in `std::` or not). (ideas from Llewellyn and Karl Nelson)

3.5 Linking

3.5.1 Almost Nothing

Or as close as it gets: freestanding. This is a minimal configuration, with only partial support for the standard library. Assume only the following header files can be used:

- `cstdarg`
- `cstddef`
- `cstdlib`
- `exception`
- `limits`
- `new`
- `exception`
- `typeinfo`

In addition, throw in

- `cxxabi.h`.

In the C++11 [dialect](#) add

- `initializer_list`
- `type_traits`

There exists a library that offers runtime support for just these headers, and it is called `libsupc++.a`. To use it, compile with `gcc` instead of `g++`, like so:

```
gcc foo.cc -lsupc++
```

No attempt is made to verify that only the minimal subset identified above is actually used at compile time. Violations are diagnosed as undefined symbols at link time.

3.5.2 Finding Dynamic or Shared Libraries

If the only library built is the static library (`libstdc++.a`), or if specifying static linking, this section can be skipped. But if building or using a shared library (`libstdc++.so`), then additional location information will need to be provided.

But how?

A quick read of the relevant part of the GCC manual, [Compiling C++ Programs](#), specifies linking against a C++ library. More details from the GCC [FAQ](#), which states *GCC does not, by default, specify a location so that the dynamic linker can find dynamic libraries at runtime.*

Users will have to provide this information.

Methods vary for different platforms and different styles, and are printed to the screen during installation. To summarize:

- At runtime set `LD_LIBRARY_PATH` in your environment correctly, so that the shared library for `libstdc++` can be found and loaded. Be certain that you understand all of the other implications and behavior of `LD_LIBRARY_PATH` first.
- Compile the path to find the library at runtime into the program. This can be done by passing certain options to `g++`, which will in turn pass them on to the linker. The exact format of the options is dependent on which linker you use:
 - GNU ld (default on GNU/Linux): `-Wl, -rpath, destdir/lib`
 - Solaris ld: `-Wl, -Rdestdir/lib`
- Some linkers allow you to specify the path to the library by setting `LD_RUN_PATH` in your environment when linking.
- On some platforms the system administrator can configure the dynamic linker to always look for libraries in `destdir/lib`, for example by using the `ldconfig` utility on GNU/Linux or the `crle` utility on Solaris. This is a system-wide change which can make the system unusable so if you are unsure then use one of the other methods described above.

Use the `ldd` utility on the linked executable to show which `libstdc++.so` library the system will get at runtime.

A `libstdc++.la` file is also installed, for use with Libtool. If you use Libtool to create your executables, these details are taken care of for you.

3.6 Concurrency

This section discusses issues surrounding the proper compilation of multithreaded applications which use the Standard C++ library. This information is GCC-specific since the C++ standard does not address matters of multithreaded applications.

3.6.1 Prerequisites

All normal disclaimers aside, multithreaded C++ application are only supported when `libstdc++` and all user code was built with compilers which report (via `gcc/g++ -v`) the same thread model and that model is not *single*. As long as your final application is actually single-threaded, then it should be safe to mix user code built with a thread model of *single* with a `libstdc++` and other C++ libraries built with another thread model useful on the platform. Other mixes may or may not work but are not considered supported. (Thus, if you distribute a shared C++ library in binary form only, it may be best to compile it with a GCC configured with `--enable-threads` for maximal interchangeability and usefulness with a user population that may have built GCC with either `--enable-threads` or `--disable-threads`.)

When you link a multithreaded application, you will probably need to add a library or flag to `g++`. This is a very non-standardized area of GCC across ports. Some ports support a special flag (the spelling isn't even standardized yet) to add all required macros to a compilation (if any such flags are required then you must provide the flag for all compilations not just linking) and link-library additions and/or replacements at link time. The documentation is weak. Here is a quick summary to display how ad hoc this is: On Solaris, both `-pthreads` and `-threads` (with subtly different meanings) are honored. On GNU/Linux x86, `-pthread` is honored. On FreeBSD, `-pthread` is honored. Some other ports use other switches. AFAIK, none of this is properly documented anywhere other than in `gcc -dumpspecs` (look at `lib` and `cpp` entries).

3.6.2 Thread Safety

In the terms of the 2011 C++ standard a thread-safe program is one which does not perform any conflicting non-atomic operations on memory locations and so does not contain any data races. The standard places requirements on the library to ensure that no data races are caused by the library itself or by programs which use the library correctly (as described below). The C++11 memory model and library requirements are a more formal version of the [SGI STL](#) definition of thread safety, which the library used prior to the 2011 standard.

The library strives to be thread-safe when all of the following conditions are met:

- The system's `libc` is itself thread-safe,

- The compiler in use reports a thread model other than 'single'. This can be tested via output from `gcc -v`. Multi-thread capable versions of gcc output something like this:

```
%gcc -v
Using built-in specs.
...
Thread model: posix
gcc version 4.1.2 20070925 (Red Hat 4.1.2-33)
```

Look for "Thread model" lines that aren't equal to "single."

- Requisite command-line flags are used for atomic operations and threading. Examples of this include `-pthread` and `-march=native`, although specifics vary depending on the host environment. See [Machine Dependent Options](#).
- An implementation of `atomic.h` functions exists for the architecture in question. See the internals documentation for more [details](#).

The user code must guard against concurrent function calls which access any particular library object's state when one or more of those accesses modifies the state. An object will be modified by invoking a non-const member function on it or passing it as a non-const argument to a library function. An object will not be modified by invoking a const member function on it or passing it to a function as a pointer- or reference-to-const. Typically, the application programmer may infer what object locks must be held based on the objects referenced in a function call and whether the objects are accessed as const or non-const. Without getting into great detail, here is an example which requires user-level locks:

```
library_class_a shared_object_a;

void thread_main () {
    library_class_b *object_b = new library_class_b;
    shared_object_a.add_b (object_b);    // must hold lock for shared_object_a
    shared_object_a.mutate ();          // must hold lock for shared_object_a
}

// Multiple copies of thread_main() are started in independent threads.
```

Under the assumption that `object_a` and `object_b` are never exposed to another thread, here is an example that does not require any user-level locks:

```
void thread_main () {
    library_class_a object_a;
    library_class_b *object_b = new library_class_b;
    object_a.add_b (object_b);
    object_a.mutate ();
}
```

All library types are safe to use in a multithreaded program if objects are not shared between threads or as long each thread carefully locks out access by any other thread while it modifies any object visible to another thread. Unless otherwise documented, the only exceptions to these rules are atomic operations on the types in `<atomic>` and lock/unlock operations on the standard mutex types in `<mutex>`. These atomic operations allow concurrent accesses to the same object without introducing data races.

The following member functions of standard containers can be considered to be const for the purposes of avoiding data races: `begin`, `end`, `rbegin`, `rend`, `front`, `back`, `data`, `find`, `lower_bound`, `upper_bound`, `equal_range`, `at` and, except in associative or unordered associative containers, `operator[]`. In other words, although they are non-const so that they can return mutable iterators, those member functions will not modify the container. Accessing an iterator might cause a non-modifying access to the container the iterator refers to (for example incrementing a list iterator must access the pointers between nodes, which are part of the container and so conflict with other accesses to the container).

Programs which follow the rules above will not encounter data races in library code, even when using library types which share state between distinct objects. In the example below the `shared_ptr` objects share a reference count, but because the code does not perform any non-const operations on the globally-visible object, the library ensures that the reference count updates are atomic and do not introduce data races:

```

std::shared_ptr<int> global_sp;

void thread_main() {
    auto local_sp = global_sp; // OK, copy constructor's parameter is reference-to-const

    int i = *global_sp;       // OK, operator* is const
    int j = *local_sp;        // OK, does not operate on global_sp

    // *global_sp = 2;        // NOT OK, modifies int visible to other threads
    // *local_sp = 2;         // NOT OK, modifies int visible to other threads

    // global_sp.reset();     // NOT OK, reset is non-const
    local_sp.reset();        // OK, does not operate on global_sp
}

int main() {
    global_sp.reset(new int(1));
    std::thread t1(thread_main);
    std::thread t2(thread_main);
    t1.join();
    t2.join();
}

```

For further details of the C++11 memory model see Hans-J. Boehm's [Threads and memory model for C++](#) pages, particularly the [introduction](#) and [FAQ](#).

3.6.3 Atomics

3.6.4 IO

This gets a bit tricky. Please read carefully, and bear with me.

3.6.4.1 Structure

A wrapper type called `__basic_file` provides our abstraction layer for the `std::filebuf` classes. Nearly all decisions dealing with actual input and output must be made in `__basic_file`.

A generic locking mechanism is somewhat in place at the filebuf layer, but is not used in the current code. Providing locking at any higher level is akin to providing locking within containers, and is not done for the same reasons (see the links above).

3.6.4.2 Defaults

The `__basic_file` type is simply a collection of small wrappers around the C stdio layer (again, see the link under Structure). We do no locking ourselves, but simply pass through to calls to `fopen`, `fwrite`, and so forth.

So, for 3.0, the question of "is multithreading safe for I/O" must be answered with, "is your platform's C library threadsafe for I/O?" Some are by default, some are not; many offer multiple implementations of the C library with varying tradeoffs of threadsafety and efficiency. You, the programmer, are always required to take care with multiple threads.

(As an example, the POSIX standard requires that C stdio FILE* operations are atomic. POSIX-conforming C libraries (e.g. on Solaris and GNU/Linux) have an internal mutex to serialize operations on FILE*s. However, you still need to not do stupid things like calling `fclose(fs)` in one thread followed by an access of `fs` in another.)

So, if your platform's C library is threadsafe, then your `fstream` I/O operations will be threadsafe at the lowest level. For higher-level operations, such as manipulating the data contained in the stream formatting classes (e.g., setting up callbacks inside an `std::ofstream`), you need to guard such accesses like any other critical shared resource.

3.6.4.3 Future

A second choice may be available for I/O implementations: `libio`. This is disabled by default, and in fact will not currently work due to other issues. It will be revisited, however.

The `libio` code is a subset of the guts of the GNU `libc` (`glibc`) I/O implementation. When `libio` is in use, the `__basic_file` type is basically derived from `FILE`. (The real situation is more complex than that... it's derived from an internal type used to implement `FILE`. See `libio/libioP.h` to see scary things done with `vtbls`.) The result is that there is no "layer" of C `stdio` to go through; the `filebuf` makes calls directly into the same functions used to implement `fread`, `fwrite`, and so forth, using internal data structures. (And when I say "makes calls directly," I mean the function is literally replaced by a jump into an internal function. Fast but frightening. *grin*)

Also, the `libio` internal locks are used. This requires pulling in large chunks of `glibc`, such as a `pthread`s implementation, and is one of the issues preventing widespread use of `libio` as the `libstdc++` `cstdio` implementation.

But we plan to make this work, at least as an option if not a future default. Platforms running a copy of `glibc` with a recent-enough version will see calls from `libstdc++` directly into the `glibc` already installed. For other platforms, a copy of the `libio` subsection will be built and included in `libstdc++`.

3.6.4.4 Alternatives

Don't forget that other `cstdio` implementations are possible. You could easily write one to perform your own forms of locking, to solve your "interesting" problems.

3.6.5 Containers

This section discusses issues surrounding the design of multithreaded applications which use Standard C++ containers. All information in this section is current as of the `gcc` 3.0 release and all later point releases. Although earlier `gcc` releases had a different approach to threading configuration and proper compilation, the basic code design rules presented here were similar. For information on all other aspects of multithreading as it relates to `libstdc++`, including details on the proper compilation of threaded code (and compatibility between threaded and non-threaded code), see Chapter 17.

Two excellent pages to read when working with the Standard C++ containers and threads are SGI's http://www.sgi.com/tech/stl/thread_safety.html and SGI's <http://www.sgi.com/tech/stl/Allocators.html>.

However, please ignore all discussions about the user-level configuration of the lock implementation inside the STL container-memory allocator on those pages. For the sake of this discussion, `libstdc++` configures the SGI STL implementation, not you. This is quite different from how `gcc` pre-3.0 worked. In particular, past advice was for people using `g++` to explicitly define `_PTHREADS` or other macros or port-specific compilation options on the command line to get a thread-safe STL. This is no longer required for any port and should no longer be done unless you really know what you are doing and assume all responsibility.

Since the container implementation of `libstdc++` uses the SGI code, we use the same definition of thread safety as SGI when discussing design. A key point that beginners may miss is the fourth major paragraph of the first page mentioned above (*For most clients...*), which points out that locking must nearly always be done outside the container, by client code (that'd be you, not us). There is a notable exceptions to this rule. Allocators called while a container or element is constructed uses an internal lock obtained and released solely within `libstdc++` code (in fact, this is the reason STL requires any knowledge of the thread configuration).

For implementing a container which does its own locking, it is trivial to provide a wrapper class which obtains the lock (as SGI suggests), performs the container operation, and then releases the lock. This could be templated *to a certain extent*, on the underlying container and/or a locking mechanism. Trying to provide a catch-all general template solution would probably be more trouble than it's worth.

The library implementation may be configured to use the high-speed caching memory allocator, which complicates thread safety issues. For all details about how to globally override this at application run-time see [here](#). Also useful are details on [allocator](#) options and capabilities.

3.7 Exceptions

The C++ language provides language support for stack unwinding with `try` and `catch` blocks and the `throw` keyword.

These are very powerful constructs, and require some thought when applied to the standard library in order to yield components that work efficiently while cleaning up resources when unexpectedly killed via exceptional circumstances.

Two general topics of discussion follow: exception neutrality and exception safety.

3.7.1 Exception Safety

What is exception-safe code?

Will define this as reasonable and well-defined behavior by classes and functions from the standard library when used by user-defined classes and functions that are themselves exception safe.

Please note that using exceptions in combination with templates imposes an additional requirement for exception safety. Instantiating types are required to have destructors that do no throw.

Using the layered approach from Abrahams, can classify library components as providing set levels of safety. These will be called exception guarantees, and can be divided into three categories.

- One. Don't throw.
As specified in 23.2.1 general container requirements. Applicable to container and string classes.
Member functions `erase`, `pop_back`, `pop_front`, `swap`, `clear`. And iterator copy constructor and assignment operator.
- Two. Don't leak resources when exceptions are thrown. This is also referred to as the "basic" exception safety guarantee.
This applicable throughout the standard library.
- Three. Commit-or-rollback semantics. This is referred to as "strong" exception safety guarantee.
As specified in 23.2.1 general container requirements. Applicable to container and string classes.
Member functions `insert` of a single element, `push_back`, `push_front`, and `rehash`.

3.7.2 Exception Neutrality

Simply put, once thrown an exception object should continue in flight unless handled explicitly. In practice, this means propagating exceptions should not be swallowed in gratuitous `catch(...)` blocks. Instead, matching `try` and `catch` blocks should have specific catch handlers and allow un-handled exception objects to propagate. If a terminating `catch(...)` blocks exist then it should end with a `throw` to re-throw the current exception.

Why do this?

By allowing exception objects to propagate, a more flexible approach to error handling is made possible (although not required.) Instead of dealing with an error immediately, one can allow the exception to propagate up until sufficient context is available and the choice of exiting or retrying can be made in an informed manner.

Unfortunately, this tends to be more of a guideline than a strict rule as applied to the standard library. As such, the following is a list of known problem areas where exceptions are not propagated.

- Input/Output
The destructor `ios_base::Init::~Init()` swallows all exceptions from `flush` called on all open streams at termination.
All formatted input in `basic_istream` or formatted output in `basic_ostream` can be configured to swallow exceptions when `exceptions` is set to `ignore` `ios_base::badbit`.
Functions that have been registered with `ios_base::register_callback` swallow all exceptions when called as part of a callback event.
When closing the underlying file, `basic_filebuf::close` will swallow (non-cancellation) exceptions thrown and return `NULL`.

- Thread

The constructors of `thread` that take a callable function argument swallow all exceptions resulting from executing the function argument.

3.7.3 Doing without

C++ is a language that strives to be as efficient as is possible in delivering features. As such, considerable care is used by both language implementer and designers to make sure unused features not impose hidden or unexpected costs. The GNU system tries to be as flexible and as configurable as possible. So, it should come as no surprise that GNU C++ provides an optional language extension, spelled `-fno-exceptions`, as a way to excise the implicitly generated magic necessary to support `try` and `catch` blocks and thrown objects. (Language support for `-fno-exceptions` is documented in the GNU GCC [manual](#).)

Before detailing the library support for `-fno-exceptions`, first a passing note on the things lost when this flag is used: it will break exceptions trying to pass through code compiled with `-fno-exceptions` whether or not that code has any `try` or `catch` constructs. If you might have some code that throws, you shouldn't use `-fno-exceptions`. If you have some code that uses `try` or `catch`, you shouldn't use `-fno-exceptions`.

And what it to be gained, tinkering in the back alleys with a language like this? Exception handling overhead can be measured in the size of the executable binary, and varies with the capabilities of the underlying operating system and specific configuration of the C++ compiler. On recent hardware with GNU system software of the same age, the combined code and data size overhead for enabling exception handling is around 7%. Of course, if code size is of singular concern than using the appropriate optimizer setting with exception handling enabled (ie, `-Os -fexceptions`) may save up to twice that, and preserve error checking.

So. Hell bent, we race down the slippery track, knowing the brakes are a little soft and that the right front wheel has a tendency to wobble at speed. Go on: detail the standard library support for `-fno-exceptions`.

In sum, valid C++ code with exception handling is transformed into a dialect without exception handling. In detailed steps: all use of the C++ keywords `try`, `catch`, and `throw` in the standard library have been permanently replaced with the pre-processor controlled equivalents spelled `__try`, `__catch`, and `__throw_exception_again`. They are defined as follows.

```
#ifdef __EXCEPTIONS
# define __try      try
# define __catch(X) catch(X)
# define __throw_exception_again throw
#else
# define __try      if (true)
# define __catch(X) if (false)
# define __throw_exception_again
#endif
```

In addition, for every object derived from class `exception`, there exists a corresponding function with C language linkage. An example:

```
#ifdef __EXCEPTIONS
void __throw_bad_exception(void)
{ throw bad_exception(); }
#else
void __throw_bad_exception(void)
{ abort(); }
#endif
```

The last language feature needing to be transformed by `-fno-exceptions` is treatment of exception specifications on member functions. Fortunately, the compiler deals with this by ignoring exception specifications and so no alternate source markup is needed.

By using this combination of language re-specification by the compiler, and the pre-processor tricks and the functional indirection layer for thrown exception objects by the library, `libstdc++` files can be compiled with `-fno-exceptions`.

User code that uses C++ keywords like `throw`, `try`, and `catch` will produce errors even if the user code has included `libstdc++` headers and is using constructs like `basic_ostream`. Even though the standard library has been transformed, user code may

need modification. User code that attempts or expects to do error checking on standard library components compiled with exception handling disabled should be evaluated and potentially made conditional.

Some issues remain with this approach (see bugzilla entry 25191). Code paths are not equivalent, in particular `catch` blocks are not evaluated. Also problematic are `throw` expressions expecting a user-defined throw handler. Known problem areas in the standard library include using an instance of `basic_istream` with `exceptions` set to specific `ios_base::iostate` conditions, or cascading `catch` blocks that dispatch error handling or recovery efforts based on the type of exception object thrown.

Oh, and by the way: none of this hackery is at all special. (Although perhaps well-deserving of a raised eyebrow.) Support continues to evolve and may change in the future. Similar and even additional techniques are used in other C++ libraries and compilers.

C++ hackers with a bent for language and control-flow purity have been successfully consoled by grizzled C veterans lamenting the substitution of the C language keyword `const` with the uglified doppelganger `__const`.

3.7.4 Compatibility

3.7.4.1 With C

C language code that is expecting to interoperate with C++ should be compiled with `-fexceptions`. This will make debugging a C language function called as part of C++-induced stack unwinding possible.

In particular, unwinding into a frame with no exception handling data will cause a runtime abort. If the unwinder runs out of unwind info before it finds a handler, `std::terminate()` is called.

Please note that most development environments should take care of getting these details right. For GNU systems, all appropriate parts of the GNU C library are already compiled with `-fexceptions`.

3.7.4.2 With POSIX thread cancellation

GNU systems re-use some of the exception handling mechanisms to track control flow for POSIX thread cancellation.

Cancellation points are functions defined by POSIX as worthy of special treatment. The standard library may use some of these functions to implement parts of the ISO C++ standard or depend on them for extensions.

Of note:

`nanosleep`, `read`, `write`, `open`, `close`, and `wait`.

The parts of `libstdc++` that use C library functions marked as cancellation points should take pains to be exception neutral. Failing this, `catch` blocks have been augmented to show that the POSIX cancellation object is in flight.

This augmentation adds a `catch` block for `__cxxabiv1::__forced_unwind`, which is the object representing the POSIX cancellation object. Like so:

```
catch(const __cxxabiv1::__forced_unwind&
{
  this->_M_setstate(ios_base::badbit);
  throw;
}
catch(...)
{ this->_M_setstate(ios_base::badbit); }
```

3.7.5 Bibliography

- [1] *System Interface Definitions, Issue 7 (IEEE Std. 1003.1-2008)* , 2.9.5 Thread Cancellation , Copyright © 2008 The Open Group/The Institute of Electrical and Electronics Engineers, Inc. .
- [2] David Abrahams , *Error and Exception Handling* , Boost .
- [3] David Abrahams , *Exception-Safety in Generic Components* , Boost .

- [4] Matt Austern, *Standard Library Exception Policy* , WG21 N1077 .
- [5] Richard Henderson, *ia64 c++ abi exception handling* , GNU .
- [6] Bjarne Stroustrup, *Appendix E: Standard-Library Exception Safety*
- [7] Herb Sutter, *Exception-Safety Issues and Techniques* .
- [8] *GCC Bug 25191: exception_defines.h #defines try/catch*

3.8 Debugging Support

There are numerous things that can be done to improve the ease with which C++ binaries are debugged when using the GNU tool chain. Here are some of them.

3.8.1 Using g++

Compiler flags determine how debug information is transmitted between compilation and debug or analysis tools.

The default optimizations and debug flags for a libstdc++ build are `-g -O2`. However, both debug and optimization flags can be varied to change debugging characteristics. For instance, turning off all optimization via the `-g -O0 -fno-inline` flags will disable inlining and optimizations, and add debugging information, so that stepping through all functions, (including inlined constructors and destructors) is possible. In addition, `-fno-eliminate-unused-debug-types` can be used when additional debug information, such as nested class info, is desired.

Or, the debug format that the compiler and debugger use to communicate information about source constructs can be changed via `-gdwarf-2` or `-gstabs` flags: some debugging formats permit more expressive type and scope information to be shown in GDB. Expressiveness can be enhanced by flags like `-g3`. The default debug information for a particular platform can be identified via the value set by the `PREFERRED_DEBUGGING_TYPE` macro in the GCC sources.

Many other options are available: please see "[Options for Debugging Your Program](#)" in Using the GNU Compiler Collection (GCC) for a complete list.

3.8.2 Debug Versions of Library Binary Files

If you would like debug symbols in libstdc++, there are two ways to build libstdc++ with debug flags. The first is to create a separate debug build by running `make` from the top-level of a tree freshly-configured with

```
--enable-libstdcxx-debug
```

and perhaps

```
--enable-libstdcxx-debug-flags='...'
```

Both the normal build and the debug build will persist, without having to specify `CXXFLAGS`, and the debug library will be installed in a separate directory tree, in `(prefix)/lib/debug`. For more information, look at the [configuration](#) section.

A second approach is to use the configuration flags

```
make CXXFLAGS='-g3 -fno-inline -O0' all
```

This quick and dirty approach is often sufficient for quick debugging tasks, when you cannot or don't want to recompile your application to use the [debug mode](#).

3.8.3 Memory Leak Hunting

There are various third party memory tracing and debug utilities that can be used to provide detailed memory allocation information about C++ code. An exhaustive list of tools is not going to be attempted, but includes `mtrace`, `valgrind`, `mudflap`, and the non-free commercial product `purify`. In addition, `libcwld` has a replacement for the global `new` and `delete` operators that can track memory allocation and deallocation and provide useful memory statistics.

Regardless of the memory debugging tool being used, there is one thing of great importance to keep in mind when debugging C++ code that uses `new` and `delete`: there are different kinds of allocation schemes that can be used by `std::allocator`. For implementation details, see the [mt allocator](#) documentation and look specifically for `GLIBCXX_FORCE_NEW`.

In a nutshell, the optional `mt_allocator` is a high-performance pool allocator, and can give the mistaken impression that in a suspect executable, memory is being leaked, when in reality the memory "leak" is a pool being used by the library's allocator and is reclaimed after program termination.

For `valgrind`, there are some specific items to keep in mind. First of all, use a version of `valgrind` that will work with current GNU C++ tools: the first that can do this is `valgrind 1.0.4`, but later versions should work at least as well. Second of all, use a completely unoptimized build to avoid confusing `valgrind`. Third, use `GLIBCXX_FORCE_NEW` to keep extraneous pool allocation noise from cluttering debug information.

Fourth, it may be necessary to force deallocation in other libraries as well, namely the "C" library. On linux, this can be accomplished with the appropriate use of the `__cxa_atexit` or `atexit` functions.

```
#include <cstdlib>

extern "C" void __libc_freeres(void);

void do_something() { }

int main()
{
    atexit(__libc_freeres);
    do_something();
    return 0;
}
```

or, using `__cxa_atexit`:

```
extern "C" void __libc_freeres(void);
extern "C" int __cxa_atexit(void (*func) (void *), void *arg, void *d);

void do_something() { }

int main()
{
    extern void* __dso_handle __attribute__((__weak__));
    __cxa_atexit((void (*) (void *)) __libc_freeres, NULL,
        &__dso_handle ? __dso_handle : NULL);
    do_test();
    return 0;
}
```

Suggested `valgrind` flags, given the suggestions above about setting up the runtime environment, library, and test file, might be:

```
valgrind -v --num-callers=20 --leak-check=yes --leak-resolution=high --show-reachable= ←
yes a.out
```

3.8.4 Data Race Hunting

All synchronization primitives used in the library internals need to be understood by race detectors so that they do not produce false reports.

Two annotation macros are used to explain low-level synchronization to race detectors: `_GLIBCXX_SYNCHRONIZATION_HAPPENS_BEFORE()` and `_GLIBCXX_SYNCHRONIZATION_HAPPENS_AFTER()`. By default, these macros are defined empty -- anyone who wants to use a race detector needs to redefine them to call an appropriate API. Since these macros are empty by default when the library is built, redefining them will only affect inline functions and template instantiations which are compiled in user code. This allows annotation of templates such as `shared_ptr`, but not code which is only instantiated in the library. Code which is only instantiated in the library needs to be recompiled with the annotation macros defined. That can be done by rebuilding the entire `libstdc++.so` file but a simpler alternative exists for ELF platforms such as GNU/Linux, because ELF symbol interposition allows symbols defined in the shared library to be overridden by symbols with the same name that appear earlier in the runtime search path. This means you only need to recompile the functions that are affected by the annotation macros, which can be done by recompiling individual files. Annotating `std::string` and `std::wstring` reference counting can be done by disabling extern templates (by defining `_GLIBCXX_EXTERN_TEMPLATE=-1`) or by rebuilding the `src/string-inst.cc` file. Annotating the remaining atomic operations (at the time of writing these are in `ios_base::Init::~~Init`, `locale::_Impl`, `locale::facet` and `thread::_M_start_thread`) requires rebuilding the relevant source files.

The approach described above is known to work with the following race detection tools: [DRD](#), [Helgrind](#), and [ThreadSanitizer](#).

With DRD, Helgrind and ThreadSanitizer you will need to define the macros like this:

```
#define _GLIBCXX_SYNCHRONIZATION_HAPPENS_BEFORE(A) ANNOTATE_HAPPENS_BEFORE(A)
#define _GLIBCXX_SYNCHRONIZATION_HAPPENS_AFTER(A) ANNOTATE_HAPPENS_AFTER(A)
```

Refer to the documentation of each particular tool for details.

3.8.5 Using gdb

Many options are available for GDB itself: please see "[GDB features for C++](#)" in the GDB documentation. Also recommended: the other parts of this manual.

These settings can either be switched on in at the GDB command line, or put into a `.gdbinit` file to establish default debugging characteristics, like so:

```
set print pretty on
set print object on
set print static-members on
set print vtbl on
set print demangle on
set demangle-style gnu-v3
```

Starting with version 7.0, GDB includes support for writing pretty-printers in Python. Pretty printers for containers and other classes are distributed with GCC from version 4.5.0 and should be installed alongside the `libstdc++` shared library files and found automatically by GDB.

Depending where `libstdc++` is installed, GDB might refuse to auto-load the python printers and print a warning instead. If this happens the python printers can be enabled by following the instructions GDB gives for setting your `auto-load safe-path` in your `.gdbinit` configuration file.

Once loaded, standard library classes that the printers support should print in a more human-readable format. To print the classes in the old style, use the `/r` (raw) switch in the print command (i.e., `print /r foo`). This will print the classes as if the Python pretty-printers were not loaded.

For additional information on STL support and GDB please visit: "[GDB Support for STL](#)" in the GDB wiki. Additionally, in-depth documentation and discussion of the pretty printing feature can be found in "Pretty Printing" node in the GDB manual. You can find on-line versions of the GDB user manual in GDB's homepage, at "[GDB: The GNU Project Debugger](#)".

3.8.6 Tracking uncaught exceptions

The [verbose termination handler](#) gives information about uncaught exceptions which kill the program.

3.8.7 Debug Mode

The **Debug Mode** has compile and run-time checks for many containers.

3.8.8 Compile Time Checking

The **Compile-Time Checks** extension has compile-time checks for many algorithms.

3.8.9 Profile-based Performance Analysis

The **Profile-based Performance Analysis** extension has performance checks for many algorithms.

Part II

Standard Contents

Chapter 4

Support

This part deals with the functions called and objects created automatically during the course of a program's existence.

While we can't reproduce the contents of the Standard here (you need to get your own copy from your nation's member body; see our homepage for help), we can mention a couple of changes in what kind of support a C++ program gets from the Standard Library.

4.1 Types

4.1.1 Fundamental Types

C++ has the following builtin types:

- char
- signed char
- unsigned char
- signed short
- signed int
- signed long
- unsigned short
- unsigned int
- unsigned long
- bool
- wchar_t
- float
- double
- long double

These fundamental types are always available, without having to include a header file. These types are exactly the same in either C++ or in C.

Specializing parts of the library on these types is prohibited: instead, use a POD.

4.1.2 Numeric Properties

The header `limits` defines traits classes to give access to various implementation defined-aspects of the fundamental types. The traits classes -- fourteen in total -- are all specializations of the template class `numeric_limits`, documented [here](#) and defined as follows:

```
template<typename T>
struct class
{
    static const bool is_specialized;
    static T max() throw();
    static T min() throw();

    static const int digits;
    static const int digits10;
    static const bool is_signed;
    static const bool is_integer;
    static const bool is_exact;
    static const int radix;
    static T epsilon() throw();
    static T round_error() throw();

    static const int min_exponent;
    static const int min_exponent10;
    static const int max_exponent;
    static const int max_exponent10;

    static const bool has_infinity;
    static const bool has_quiet_NaN;
    static const bool has_signaling_NaN;
    static const float_denorm_style has_denorm;
    static const bool has_denorm_loss;
    static T infinity() throw();
    static T quiet_NaN() throw();
    static T denorm_min() throw();

    static const bool is_iec559;
    static const bool is_bounded;
    static const bool is_modulo;

    static const bool traps;
    static const bool tinyness_before;
    static const float_round_style round_style;
};
```

4.1.3 NULL

The only change that might affect people is the type of `NULL`: while it is required to be a macro, the definition of that macro is *not* allowed to be `(void*)0`, which is often used in C.

For `g++`, `NULL` is `#define'd` to be `__null`, a magic keyword extension of `g++`.

The biggest problem of `#defining` `NULL` to be something like “0L” is that the compiler will view that as a long integer before it views it as a pointer, so overloading won't do what you expect. (This is why `g++` has a magic extension, so that `NULL` is always a pointer.)

In his book *Effective C++*, Scott Meyers points out that the best way to solve this problem is to not overload on pointer-vs-integer types to begin with. He also offers a way to make your own magic `NULL` that will match pointers before it matches integers.

See the *Effective C++ CD* example.

4.2 Dynamic Memory

There are six flavors each of `new` and `delete`, so make certain that you're using the right ones. Here are quickie descriptions of `new`:

- single object form, throwing a `bad_alloc` on errors; this is what most people are used to using
- Single object "nothrow" form, returning `NULL` on errors
- Array `new`, throwing `bad_alloc` on errors
- Array nothrow `new`, returning `NULL` on errors
- Placement `new`, which does nothing (like it's supposed to)
- Placement array `new`, which also does nothing

They are distinguished by the parameters that you pass to them, like any other overloaded function. The six flavors of `delete` are distinguished the same way, but none of them are allowed to throw an exception under any circumstances anyhow. (They match up for completeness' sake.)

Remember that it is perfectly okay to call `delete` on a `NULL` pointer! Nothing happens, by definition. That is not the same thing as deleting a pointer twice.

By default, if one of the "throwing news" can't allocate the memory requested, it tosses an instance of a `bad_alloc` exception (or, technically, some class derived from it). You can change this by writing your own function (called a new-handler) and then registering it with `set_new_handler()`:

```
typedef void (*PFV) (void);

static char*  safety;
static PFV   old_handler;

void my_new_handler ()
{
    delete[] safety;
    popup_window ("Dude, you are running low on heap memory.  You
                 should, like, close some windows, or something.
                 The next time you run out, we're gonna burn!");
    set_new_handler (old_handler);
    return;
}

int main ()
{
    safety = new char[500000];
    old_handler = set_new_handler (&my_new_handler);
    ...
}
```

`bad_alloc` is derived from the base `exception` class defined in Sect1 19.

4.3 Termination

4.3.1 Termination Handlers

Not many changes here to `cstdlib`. You should note that the `abort()` function does not call the destructors of automatic nor static objects, so if you're depending on those to do cleanup, it isn't going to happen. (The functions registered with `atexit()` don't get called either, so you can forget about that possibility, too.)

The good old `exit()` function can be a bit funky, too, until you look closer. Basically, three points to remember are:

1. Static objects are destroyed in reverse order of their creation.
2. Functions registered with `atexit()` are called in reverse order of registration, once per registration call. (This isn't actually new.)
3. The previous two actions are "interleaved," that is, given this pseudocode:

```
extern "C or C++" void f1 (void);
extern "C or C++" void f2 (void);

static Thing obj1;
atexit(f1);
static Thing obj2;
atexit(f2);
```

then at a call of `exit()`, `f2` will be called, then `obj2` will be destroyed, then `f1` will be called, and finally `obj1` will be destroyed. If `f1` or `f2` allow an exception to propagate out of them, Bad Things happen.

Note also that `atexit()` is only required to store 32 functions, and the compiler/library might already be using some of those slots. If you think you may run out, we recommend using the `xatexit/xexit` combination from `libiberty`, which has no such limit.

4.3.2 Verbose Terminate Handler

If you are having difficulty with uncaught exceptions and want a little bit of help debugging the causes of the core dumps, you can make use of a GNU extension, the verbose terminate handler.

```
#include <exception>

int main()
{
    std::set_terminate(__gnu_cxx::__verbose_terminate_handler);
    ...

    throw anything;
}
```

The `__verbose_terminate_handler` function obtains the name of the current exception, attempts to demangle it, and prints it to `stderr`. If the exception is derived from `exception` then the output from `what()` will be included.

Any replacement termination function is required to kill the program without returning; this one calls `abort`.

For example:

```
#include <exception>
#include <stdexcept>

struct argument_error : public std::runtime_error
{
    argument_error(const std::string& s): std::runtime_error(s) { }
};

int main(int argc)
{
    std::set_terminate(__gnu_cxx::__verbose_terminate_handler);
    if (argc > 5)
        throw argument_error(argc is greater than 5!);
    else
        throw argc;
}
```

With the verbose terminate handler active, this gives:

```
% ./a.out
terminate called after throwing a `int`
Aborted
% ./a.out f f f f f f f f f f
terminate called after throwing an instance of `argument_error`
what(): argc is greater than 5!
Aborted
```

The 'Aborted' line comes from the call to `abort()`, of course.

This is the default termination handler; nothing need be done to use it. To go back to the previous “silent death” method, simply include `exception` and `cstdlib`, and call

```
std::set_terminate(std::abort);
```

After this, all calls to `terminate` will use `abort` as the terminate handler.

Note: the verbose terminate handler will attempt to write to `stderr`. If your application closes `stderr` or redirects it to an inappropriate location, `__verbose_terminate_handler` will behave in an unspecified manner.

Chapter 5

Diagnostics

5.1 Exceptions

5.1.1 API Reference

All exception objects are defined in one of the standard header files: `exception`, `stdexcept`, `new`, and `typeinfo`.

The base exception object is `exception`, located in `exception`. This object has no `string` member.

Derived from this are several classes that may have a `string` member: a full hierarchy can be found in the source documentation.

Full API details.

5.1.2 Adding Data to `exception`

The standard exception classes carry with them a single string as data (usually describing what went wrong or where the 'throw' took place). It's good to remember that you can add your own data to these exceptions when extending the hierarchy:

```
struct My_Exception : public std::runtime_error
{
    public:
        My_Exception (const string& whatarg)
        : std::runtime_error(whatarg), e(errno), id(GetDataBaseID()) { }
        int  errno_at_time_of_throw() const { return e; }
        DBID id_of_thing_that_threw() const { return id; }
    protected:
        int    e;
        DBID  id;    // some user-defined type
};
```

5.2 Concept Checking

In 1999, SGI added "concept checkers" to their implementation of the STL: code which checked the template parameters of instantiated pieces of the STL, in order to insure that the parameters being used met the requirements of the standard. For example, the Standard requires that types passed as template parameters to `vector` be "Assignable" (which means what you think it means). The checking was done during compilation, and none of the code was executed at runtime.

Unfortunately, the size of the compiler files grew significantly as a result. The checking code itself was cumbersome. And bugs were found in it on more than one occasion.

The primary author of the checking code, Jeremy Siek, had already started work on a replacement implementation. The new code was formally reviewed and accepted into [the Boost libraries](#), and we are pleased to incorporate it into the GNU C++ library.

The new version imposes a much smaller space overhead on the generated object file. The checks are also cleaner and easier to read and understand.

They are off by default for all versions of GCC. They can be enabled at configure time with `--enable-concept-checks`. You can enable them on a per-translation-unit basis with `-D_GLIBCXX_CONCEPT_CHECKS`.

Please note that the checks are based on the requirements in the original C++ standard, some of which have changed in the new C++11 revision. Additionally, some correct code might be rejected by the concept checks, for example template argument types may need to be complete when used in a template definition, rather than at the point of instantiation. There are no plans to address these shortcomings.

Chapter 6

Utilities

6.1 Functors

If you don't know what functors are, you're not alone. Many people get slightly the wrong idea. In the interest of not reinventing the wheel, we will refer you to the introduction to the functor concept written by SGI as part of their STL, in [their `http://www.sgi.com/tech/stl/functors.html`](http://www.sgi.com/tech/stl/functors.html).

6.2 Pairs

The `pair<T1, T2>` is a simple and handy way to carry around a pair of objects. One is of type `T1`, and another of type `T2`; they may be the same type, but you don't get anything extra if they are. The two members can be accessed directly, as `.first` and `.second`.

Construction is simple. The default ctor initializes each member with its respective default ctor. The other simple ctor,

```
pair (const T1& x, const T2& y);
```

does what you think it does, `first` getting `x` and `second` getting `y`.

There is a constructor template for copying pairs of other types:

```
template <class U, class V> pair (const pair<U,V>& p);
```

The compiler will convert as necessary from `U` to `T1` and from `V` to `T2` in order to perform the respective initializations.

The comparison operators are done for you. Equality of two `pair<T1, T2>`s is defined as both `first` members comparing equal and both `second` members comparing equal; this simply delegates responsibility to the respective `operator==` functions (for types like `MyClass`) or builtin comparisons (for types like `int`, `char`, etc).

The less-than operator is a bit odd the first time you see it. It is defined as evaluating to:

```
x.first < y.first ||
( !(y.first < x.first) && x.second < y.second )
```

The other operators are not defined using the `rel_ops` functions above, but their semantics are the same.

Finally, there is a template function called `make_pair` that takes two references-to-const objects and returns an instance of a pair instantiated on their respective types:

```
pair<int,MyClass> p = make_pair(4,myobject);
```

6.3 Memory

Memory contains three general areas. First, function and operator calls via `new` and `delete` operator or member function calls. Second, allocation via `allocator`. And finally, smart pointer and intelligent pointer abstractions.

6.3.1 Allocators

Memory management for Standard Library entities is encapsulated in a class template called `allocator`. The `allocator` abstraction is used throughout the library in `string`, container classes, algorithms, and parts of `iostreams`. This class, and base classes of it, are the superset of available free store (“heap”) management classes.

6.3.1.1 Requirements

The C++ standard only gives a few directives in this area:

- When you add elements to a container, and the container must allocate more memory to hold them, the container makes the request via its `Allocator` template parameter, which is usually aliased to `allocator_type`. This includes adding chars to the `string` class, which acts as a regular STL container in this respect.
- The default `Allocator` argument of every container-of-`T` is `allocator<T>`.
- The interface of the `allocator<T>` class is extremely simple. It has about 20 public declarations (nested typedefs, member functions, etc), but the two which concern us most are:

```
T*    allocate (size_type n, const void* hint = 0);
void deallocate (T* p, size_type n);
```

The `n` arguments in both those functions is a *count* of the number of `T`'s to allocate space for, *not their total size*. (This is a simplification; the real signatures use nested typedefs.)

- The storage is obtained by calling `::operator new`, but it is unspecified when or how often this function is called. The use of the `hint` is unspecified, but intended as an aid to locality if an implementation so desires. [20.4.1.1]/6

Complete details can be found in the C++ standard, look in [20.4 Memory].

6.3.1.2 Design Issues

The easiest way of fulfilling the requirements is to call `operator new` each time a container needs memory, and to call `operator delete` each time the container releases memory. This method may be **slower** than caching the allocations and re-using previously-allocated memory, but has the advantage of working correctly across a wide variety of hardware and operating systems, including large clusters. The `__gnu_cxx::new_allocator` implements the simple `operator new` and `operator delete` semantics, while `__gnu_cxx::malloc_allocator` implements much the same thing, only with the C language functions `std::malloc` and `std::free`.

Another approach is to use intelligence within the `allocator` class to cache allocations. This extra machinery can take a variety of forms: a bitmap index, an index into an exponentially increasing power-of-two-sized buckets, or simpler fixed-size pooling cache. The cache is shared among all the containers in the program: when your program's `std::vector<int>` gets cut in half and frees a bunch of its storage, that memory can be reused by the private `std::list<WonkyWidget>` brought in from a KDE library that you linked against. And operators `new` and `delete` are not always called to pass the memory on, either, which is a speed bonus. Examples of allocators that use these techniques are `__gnu_cxx::bitmap_allocator`, `__gnu_cxx::pool_allocator`, and `__gnu_cxx::__mt_alloc`.

Depending on the implementation techniques used, the underlying operating system, and compilation environment, scaling caching allocators can be tricky. In particular, order-of-destruction and order-of-creation for memory pools may be difficult to pin down with certainty, which may create problems when used with plugins or loading and unloading shared objects in memory. As such, using caching allocators on systems that do not support `abi::__cxa_atexit` is not recommended.

6.3.1.3 Implementation

6.3.1.3.1 Interface Design

The only allocator interface that is supported is the standard C++ interface. As such, all STL containers have been adjusted, and all external allocators have been modified to support this change.

The class `allocator` just has `typedef`, `constructor`, and `rebind` members. It inherits from one of the high-speed extension allocators, covered below. Thus, all allocation and deallocation depends on the base class.

The base class that `allocator` is derived from may not be user-configurable.

6.3.1.3.2 Selecting Default Allocation Policy

It's difficult to pick an allocation strategy that will provide maximum utility, without excessively penalizing some behavior. In fact, it's difficult just deciding which typical actions to measure for speed.

Three synthetic benchmarks have been created that provide data that is used to compare different C++ allocators. These tests are:

1. Insertion.

Over multiple iterations, various STL container objects have elements inserted to some maximum amount. A variety of allocators are tested. Test source for [sequence](#) and [associative](#) containers.

2. Insertion and erasure in a multi-threaded environment.

This test shows the ability of the allocator to reclaim memory on a per-thread basis, as well as measuring thread contention for memory resources. Test source [here](#).

3. A threaded producer/consumer model.

Test source for [sequence](#) and [associative](#) containers.

The current default choice for `allocator` is `__gnu_cxx::new_allocator`.

6.3.1.3.3 Disabling Memory Caching

In use, `allocator` may allocate and deallocate using implementation-specific strategies and heuristics. Because of this, a given call to an allocator object's `allocate` member function may not actually call the global operator `new` and a given call to the `deallocate` member function may not call operator `delete`.

This can be confusing.

In particular, this can make debugging memory errors more difficult, especially when using third-party tools like `valgrind` or debug versions of `new`.

There are various ways to solve this problem. One would be to use a custom allocator that just called operators `new` and `delete` directly, for every allocation. (See the default allocator, `include/ext/new_allocator.h`, for instance.) However, that option may involve changing source code to use a non-default allocator. Another option is to force the default allocator to remove caching and pools, and to directly allocate with every call of `allocate` and directly deallocate with every call of `deallocate`, regardless of efficiency. As it turns out, this last option is also available.

To globally disable memory caching within the library for some of the optional non-default allocators, merely set `GLIBCXX_FORCE_NEW` (with any value) in the system's environment before running the program. If your program crashes with `GLIBCXX_FORCE_NEW` in the environment, it likely means that you linked against objects built against the older library (objects which might still using the cached allocations...).

6.3.1.4 Using a Specific Allocator

You can specify different memory management schemes on a per-container basis, by overriding the default Allocator template parameter. For example, an easy (but non-portable) method of specifying that only `malloc` or `free` should be used instead of the default node allocator is:

```
std::list <int, __gnu_cxx::malloc_allocator<int> > malloc_list;
```

Likewise, a debugging form of whichever allocator is currently in use:

```
std::deque <int, __gnu_cxx::debug_allocator<std::allocator<int> > > debug_deque;
```

6.3.1.5 Custom Allocators

Writing a portable C++ allocator would dictate that the interface would look much like the one specified for `allocator`. Additional member functions, but not subtractions, would be permissible.

Probably the best place to start would be to copy one of the extension allocators: say a simple one like `new_allocator`.

6.3.1.6 Extension Allocators

Several other allocators are provided as part of this implementation. The location of the extension allocators and their names have changed, but in all cases, functionality is equivalent. Starting with `gcc-3.4`, all extension allocators are standard style. Before this point, SGI style was the norm. Because of this, the number of template arguments also changed. Here's a simple chart to track the changes.

More details on each of these extension allocators follows.

1. `new_allocator`

Simply wraps `::operator new` and `::operator delete`.

2. `malloc_allocator`

Simply wraps `malloc` and `free`. There is also a hook for an out-of-memory handler (for `new/delete` this is taken care of elsewhere).

3. `array_allocator`

Allows allocations of known and fixed sizes using existing global or external storage allocated via construction of `std::tr1::array` objects. By using this allocator, fixed size containers (including `std::string`) can be used without instances calling `::operator new` and `::operator delete`. This capability allows the use of STL abstractions without runtime complications or overhead, even in situations such as program startup. For usage examples, please consult the testsuite.

4. `debug_allocator`

A wrapper around an arbitrary allocator `A`. It passes on slightly increased size requests to `A`, and uses the extra memory to store size information. When a pointer is passed to `deallocate()`, the stored size is checked, and `assert()` is used to guarantee they match.

5. `throw_allocator`

Includes memory tracking and marking abilities as well as hooks for throwing exceptions at configurable intervals (including `random`, `all`, `none`).

6. `__pool_alloc`

A high-performance, single pool allocator. The reusable memory is shared among identical instantiations of this type. It calls through `::operator new` to obtain new memory when its lists run out. If a client container requests a block larger than a certain threshold size, then the pool is bypassed, and the `allocate/deallocate` request is passed to `::operator new` directly.

Older versions of this class take a boolean template parameter, called `thr`, and an integer template parameter, called `inst`. The `inst` number is used to track additional memory pools. The point of the number is to allow multiple instantiations of the classes without changing the semantics at all. All three of

```
typedef __pool_alloc<true,0>    normal;
typedef __pool_alloc<true,1>    private;
typedef __pool_alloc<true,42>   also_private;
```

behave exactly the same way. However, the memory pool for each type (and remember that different instantiations result in different types) remains separate.

The library uses 0 in all its instantiations. If you wish to keep separate free lists for a particular purpose, use a different number.

The `thr` boolean determines whether the pool should be manipulated atomically or not. When `thr = true`, the allocator is thread-safe, while `thr = false`, is slightly faster but unsafe for multiple threads.

For thread-enabled configurations, the pool is locked with a single big lock. In some situations, this implementation detail may result in severe performance degradation.

(Note that the GCC thread abstraction layer allows us to provide safe zero-overhead stubs for the threading routines, if threads were disabled at configuration time.)

7. `__mt_alloc`

A high-performance fixed-size allocator with exponentially-increasing allocations. It has its own [chapter](#) in the documentation.

8. `bitmap_allocator`

A high-performance allocator that uses a bit-map to keep track of the used and unused memory locations. It has its own [chapter](#) in the documentation.

6.3.1.7 Bibliography

[9] Matt Austern, *The Standard Librarian: What Are Allocators Good For?* , C/C++ Users Journal .

[10] Emery Berger, *The Hoard Memory Allocator*

[11] Emery BergerBen ZornKathryn McKinley, *Reconsidering Custom Memory Allocation* , Copyright © 2002 OOPSLA.

[12] Klaus KreftAngelika Langer, *Allocator Types* , C/C++ Users Journal .

[13] Bjarne Stroustrup, Copyright © 2000 , 19.4 Allocators, Addison Wesley .

[14] Felix Yen

[isoc++_1998] , 20.4 Memory.

6.3.2 `auto_ptr`

6.3.2.1 Limitations

Explaining all of the fun and delicious things that can happen with misuse of the `auto_ptr` class template (called AP here) would take some time. Suffice it to say that the use of AP safely in the presence of copying has some subtleties.

The AP class is a really nifty idea for a smart pointer, but it is one of the dumbest of all the smart pointers -- and that's fine.

AP is not meant to be a supersmart solution to all resource leaks everywhere. Neither is it meant to be an effective form of garbage collection (although it can help, a little bit). And it can *not* be used for arrays!

AP is meant to prevent nasty leaks in the presence of exceptions. That's *all*. This code is AP-friendly:

```

// Not a recommend naming scheme, but good for web-based FAQs.
typedef std::auto_ptr<MyClass>  APMC;

extern function_taking_MyClass_pointer (MyClass*);
extern some_throwable_function ();

void func (int data)
{
  APMC  ap (new MyClass(data));

  some_throwable_function();  // this will throw an exception

  function_taking_MyClass_pointer (ap.get());
}

```

When an exception gets thrown, the instance of `MyClass` that's been created on the heap will be delete'd as the stack is unwound past `func()`.

Changing that code as follows is not AP-friendly:

```

APMC  ap (new MyClass[22]);

```

You will get the same problems as you would without the use of AP:

```

char*  array = new char[10];      // array new...
...
delete array;                    // ...but single-object delete

```

AP cannot tell whether the pointer you've passed at creation points to one or many things. If it points to many things, you are about to die. AP is trivial to write, however, so you could write your own `auto_array_ptr` for that situation (in fact, this has been done many times; check the mailing lists, Usenet, Boost, etc).

6.3.2.2 Use in Containers

All of the **containers** described in the standard library require their contained types to have, among other things, a copy constructor like this:

```

struct My_Type
{
  My_Type (My_Type const&);
};

```

Note the `const` keyword; the object being copied shouldn't change. The template class `auto_ptr` (called AP here) does not meet this requirement. Creating a new AP by copying an existing one transfers ownership of the pointed-to object, which means that the AP being copied must change, which in turn means that the copy ctors of AP do not take `const` objects.

The resulting rule is simple: *Never ever use a container of `auto_ptr` objects.* The standard says that "undefined" behavior is the result, but it is guaranteed to be messy.

To prevent you from doing this to yourself, the **concept checks** built in to this implementation will issue an error if you try to compile code like this:

```

#include <vector>
#include <memory>

void f()
{
  std::vector< std::auto_ptr<int> >  vec_ap_int;
}

```

Should you try this with the checks enabled, you will see an error.

6.3.3 shared_ptr

The `shared_ptr` class template stores a pointer, usually obtained via `new`, and implements shared ownership semantics.

6.3.3.1 Requirements

The standard deliberately doesn't require a reference-counted implementation, allowing other techniques such as a circular-linked-list.

6.3.3.2 Design Issues

The `shared_ptr` code is kindly donated to GCC by the Boost project and the original authors of the code. The basic design and algorithms are from Boost, the notes below describe details specific to the GCC implementation. Names have been uglified in this implementation, but the design should be recognisable to anyone familiar with the Boost 1.32 `shared_ptr`.

The basic design is an abstract base class, `_Sp_counted_base` that does the reference-counting and calls virtual functions when the count drops to zero. Derived classes override those functions to destroy resources in a context where the correct dynamic type is known. This is an application of the technique known as type erasure.

6.3.3.3 Implementation

6.3.3.3.1 Class Hierarchy

A `shared_ptr<T>` contains a pointer of type `T*` and an object of type `__shared_count`. The `shared_count` contains a pointer of type `_Sp_counted_base*` which points to the object that maintains the reference-counts and destroys the managed resource.

`_Sp_counted_base<Lp>` The base of the hierarchy is parameterized on the lock policy (see below.) `_Sp_counted_base` doesn't depend on the type of pointer being managed, it only maintains the reference counts and calls virtual functions when the counts drop to zero. The managed object is destroyed when the last strong reference is dropped, but the `_Sp_counted_base` itself must exist until the last weak reference is dropped.

`_Sp_counted_base_impl<Ptr, Deleter, Lp>` Inherits from `_Sp_counted_base` and stores a pointer of type `Ptr` and a deleter of type `Deleter`. `_Sp_deleter` is used when the user doesn't supply a custom deleter. Unlike Boost's, this default deleter is not "checked" because GCC already issues a warning if `delete` is used with an incomplete type. This is the only derived type used by `tr1::shared_ptr<Ptr>` and it is never used by `std::shared_ptr`, which uses one of the following types, depending on how the `shared_ptr` is constructed.

`_Sp_counted_ptr<Ptr, Lp>` Inherits from `_Sp_counted_base` and stores a pointer of type `Ptr`, which is passed to `delete` when the last reference is dropped. This is the simplest form and is used when there is no custom deleter or allocator.

`_Sp_counted_deleter<Ptr, Deleter, Alloc>` Inherits from `_Sp_counted_ptr` and adds support for custom deleter and allocator. Empty Base Optimization is used for the allocator. This class is used even when the user only provides a custom deleter, in which case `allocator` is used as the allocator.

`_Sp_counted_ptr_inplace<Tp, Alloc, Lp>` Used by `allocate_shared` and `make_shared`. Contains aligned storage to hold an object of type `Tp`, which is constructed in-place with placement `new`. Has a variadic template constructor allowing any number of arguments to be forwarded to `Tp`'s constructor. Unlike the other `_Sp_counted_*` classes, this one is parameterized on the type of object, not the type of pointer; this is purely a convenience that simplifies the implementation slightly.

C++11-only features are: rvalue-ref/move support, allocator support, aliasing constructor, `make_shared` & `allocate_shared`. Additionally, the constructors taking `auto_ptr` parameters are deprecated in C++11 mode.

6.3.3.3.2 Thread Safety

The [Thread Safety](#) section of the Boost `shared_ptr` documentation says "shared_ptr objects offer the same level of thread safety as built-in types." The implementation must ensure that concurrent updates to separate `shared_ptr` instances are correct even when those instances share a reference count e.g.

```
shared_ptr<A> a(new A);
shared_ptr<A> b(a);

// Thread 1      // Thread 2
  a.reset();    b.reset();
```

The dynamically-allocated object must be destroyed by exactly one of the threads. Weak references make things even more interesting. The shared state used to implement `shared_ptr` must be transparent to the user and invariants must be preserved at all times. The key pieces of shared state are the strong and weak reference counts. Updates to these need to be atomic and visible to all threads to ensure correct cleanup of the managed resource (which is, after all, `shared_ptr`'s job!) On multi-processor systems memory synchronisation may be needed so that reference-count updates and the destruction of the managed resource are race-free.

The function `_Sp_counted_base::_M_add_ref_lock()`, called when obtaining a `shared_ptr` from a `weak_ptr`, has to test if the managed resource still exists and either increment the reference count or throw `bad_weak_ptr`. In a multi-threaded program there is a potential race condition if the last reference is dropped (and the managed resource destroyed) between testing the reference count and incrementing it, which could result in a `shared_ptr` pointing to invalid memory.

The Boost `shared_ptr` (as used in GCC) features a clever lock-free algorithm to avoid the race condition, but this relies on the processor supporting an atomic *Compare-And-Swap* instruction. For other platforms there are fall-backs using mutex locks. Boost (as of version 1.35) includes several different implementations and the preprocessor selects one based on the compiler, standard library, platform etc. For the version of `shared_ptr` in `libstdc++` the compiler and library are fixed, which makes things much simpler: we have an atomic CAS or we don't, see [Lock Policy](#) below for details.

6.3.3.3.3 Selecting Lock Policy

There is a single `_Sp_counted_base` class, which is a template parameterized on the enum `__gnu_cxx::Lock_policy`. The entire family of classes is parameterized on the lock policy, right up to `__shared_ptr`, `__weak_ptr` and `__enable_shared_from_this`. The actual `std::shared_ptr` class inherits from `__shared_ptr` with the lock policy parameter selected automatically based on the thread model and platform that `libstdc++` is configured for, so that the best available template specialization will be used. This design is necessary because it would not be conforming for `shared_ptr` to have an extra template parameter, even if it had a default value. The available policies are:

1. `_S_Atomic`

Selected when GCC supports a builtin atomic compare-and-swap operation on the target processor (see [Atomic Builtins](#).) The reference counts are maintained using a lock-free algorithm and GCC's atomic builtins, which provide the required memory synchronisation.

2. `_S_Mutex`

The `_Sp_counted_base` specialization for this policy contains a mutex, which is locked in `add_ref_lock()`. This policy is used when GCC's atomic builtins aren't available so explicit memory barriers are needed in places.

3. `_S_Single`

This policy uses a non-reentrant `add_ref_lock()` with no locking. It is used when `libstdc++` is built without `--enable-threads`.

For all three policies, reference count increments and decrements are done via the functions in `ext/atomicity.h`, which detect if the program is multi-threaded. If only one thread of execution exists in the program then less expensive non-atomic operations are used.

6.3.3.3.4 Related functions and classes

dynamic_pointer_cast, static_pointer_cast, const_pointer_cast As noted in N2351, these functions can be implemented non-intrusively using the alias constructor. However the aliasing constructor is only available in C++11 mode, so in TR1 mode these casts rely on three non-standard constructors in `shared_ptr` and `__shared_ptr`. In C++11 mode these constructors and the related tag types are not needed.

enable_shared_from_this The clever overload to detect a base class of type `enable_shared_from_this` comes straight from Boost. There is an extra overload for `__enable_shared_from_this` to work smoothly with `__shared_ptr<Tp, Lp>` using any lock policy.

make_shared, allocate_shared `make_shared` simply forwards to `allocate_shared` with `std::allocator` as the allocator. Although these functions can be implemented non-intrusively using the alias constructor, if they have access to the implementation then it is possible to save storage and reduce the number of heap allocations. The newly constructed object and the `_Sp_counted_*` can be allocated in a single block and the standard says implementations are "encouraged, but not required," to do so. This implementation provides additional non-standard constructors (selected with the type `_Sp_make_shared_tag`) which create an object of type `_Sp_counted_ptr_inplace` to hold the new object. The returned `shared_ptr<A>` needs to know the address of the new `A` object embedded in the `_Sp_counted_ptr_inplace`, but it has no way to access it. This implementation uses a "covert channel" to return the address of the embedded object when `get_deleter<_Sp_make_shared_tag>()` is called. Users should not try to use this. As well as the extra constructors, this implementation also needs some members of `_Sp_counted_deleter` to be protected where they could otherwise be private.

6.3.3.4 Use

6.3.3.4.1 Examples

Examples of use can be found in the testsuite, under `testsuite/tr1/2_general_utilities/shared_ptr`, `testsuite/20_util/shared_ptr` and `testsuite/20_util/weak_ptr`.

6.3.3.4.2 Unresolved Issues

The `shared_ptr atomic access` clause in the C++11 standard is not implemented in GCC.

The `_S_single` policy uses atomics when used in MT code, because it uses the same dispatcher functions that check `__gthread_active_p()`. This could be addressed by providing template specialisations for some members of `_Sp_counted_base<_S_single>`.

Unlike Boost, this implementation does not use separate classes for the pointer+deleter and pointer+deleter+allocator cases in C++11 mode, combining both into `_Sp_counted_deleter` and using `allocator` when the user doesn't specify an allocator. If it was found to be beneficial an additional class could easily be added. With the current implementation, the `_Sp_counted_deleter` and `__shared_count` constructors taking a custom deleter but no allocator are technically redundant and could be removed, changing callers to always specify an allocator. If a separate pointer+deleter class was added the `__shared_count` constructor would be needed, so it has been kept for now.

The hack used to get the address of the managed object from `_Sp_counted_ptr_inplace::_M_get_deleter()` is accessible to users. This could be prevented if `get_deleter<_Sp_make_shared_tag>()` always returned `NULL`, since the hack only needs to work at a lower level, not in the public API. This wouldn't be difficult, but hasn't been done since there is no danger of accidental misuse: users already know they are relying on unsupported features if they refer to implementation details such as `_Sp_make_shared_tag`.

`tr1::_Sp_deleter` could be a private member of `tr1::__shared_count` but it would alter the ABI.

6.3.3.5 Acknowledgments

The original authors of the Boost `shared_ptr`, which is really nice code to work with, Peter Dimov in particular for his help and invaluable advice on thread safety. Phillip Jordan and Paolo Carlini for the lock policy implementation.

6.3.3.6 Bibliography

- [15] *Improving `shared_ptr` for C++0x, Revision 2* , N2351 .
- [16] *C++ Standard Library Active Issues List* , N2456 .
- [17] *Working Draft, Standard for Programming Language C++* , N2461 .
- [18] *Boost C++ Libraries documentation, `shared_ptr`* , N2461 .

6.4 Traits

Chapter 7

Strings

7.1 String Classes

7.1.1 Simple Transformations

Here are Standard, simple, and portable ways to perform common transformations on a `string` instance, such as "convert to all upper case." The word transformations is especially apt, because the standard template function `transform<>` is used.

This code will go through some iterations. Here's a simple version:

```
#include <string>
#include <algorithm>
#include <ctype>      // old <ctype.h>

struct ToLower
{
    char operator() (char c) const { return std::tolower(c); }
};

struct ToUpper
{
    char operator() (char c) const { return std::toupper(c); }
};

int main()
{
    std::string s ("Some Kind Of Initial Input Goes Here");

    // Change everything into upper case
    std::transform (s.begin(), s.end(), s.begin(), ToUpper());

    // Change everything into lower case
    std::transform (s.begin(), s.end(), s.begin(), ToLower());

    // Change everything back into upper case, but store the
    // result in a different string
    std::string capital_s;
    capital_s.resize(s.size());
    std::transform (s.begin(), s.end(), capital_s.begin(), ToUpper());
}
```

Note that these calls all involve the global C locale through the use of the C functions `toupper/tolower`. This is absolutely guaranteed to work -- but *only* if the string contains *only* characters from the basic source character set, and there are *only* 96 of

those. Which means that not even all English text can be represented (certain British spellings, proper names, and so forth). So, if all your input forevermore consists of only those 96 characters (hahahahahaha), then you're done.

Note that the `ToUpper` and `ToLower` function objects are needed because `toupper` and `tolower` are overloaded names (declared in `<cctype>` and `<locale>`) so the template-arguments for `transform<>` cannot be deduced, as explained in [this message](#). At minimum, you can write short wrappers like

```
char toLower (char c)
{
    return std::tolower(c);
}
```

(Thanks to James Kanze for assistance and suggestions on all of this.)

Another common operation is trimming off excess whitespace. Much like transformations, this task is trivial with the use of `string`'s `find` family. These examples are broken into multiple statements for readability:

```
std::string str (" \t blah blah blah \n ");

// trim leading whitespace
string::size_type notwhite = str.find_first_not_of(" \t\n");
str.erase(0,notwhite);

// trim trailing whitespace
notwhite = str.find_last_not_of(" \t\n");
str.erase(notwhite+1);
```

Obviously, the calls to `find` could be inserted directly into the calls to `erase`, in case your compiler does not optimize named temporaries out of existence.

7.1.2 Case Sensitivity

The well-known-and-if-it-isn't-well-known-it-ought-to-be [Guru of the Week](#) discussions held on Usenet covered this topic in January of 1998. Briefly, the challenge was, "write a `'ci_string'` class which is identical to the standard `'string'` class, but is case-insensitive in the same way as the (common but nonstandard) C function `stricmp()`".

```
ci_string s( "AbCdE" );

// case insensitive
assert( s == "abcde" );
assert( s == "ABCDE" );

// still case-preserving, of course
assert( strcmp( s.c_str(), "AbCdE" ) == 0 );
assert( strcmp( s.c_str(), "abcde" ) != 0 );
```

The solution is surprisingly easy. The original answer was posted on Usenet, and a revised version appears in Herb Sutter's book *Exceptional C++* and on his website as [GotW 29](#).

See? Told you it was easy!

Added June 2000: The May 2000 issue of C++ Report contains a fascinating [article](#) by Matt Austern (yes, *the* Matt Austern) on why case-insensitive comparisons are not as easy as they seem, and why creating a class is the *wrong* way to go about it in production code. (The GotW answer mentions one of the principle difficulties; his article mentions more.)

Basically, this is "easy" only if you ignore some things, things which may be too important to your program to ignore. (I chose to ignore them when originally writing this entry, and am surprised that nobody ever called me on it...) The GotW question and answer remain useful instructional tools, however.

Added September 2000: James Kanze provided a link to a [Unicode Technical Report discussing case handling](#), which provides some very good information.

7.1.3 Arbitrary Character Types

The `std::basic_string` is tantalizingly general, in that it is parameterized on the type of the characters which it holds. In theory, you could whip up a Unicode character class and instantiate `std::basic_string<my_unicode_char>`, or assuming that integers are wider than characters on your platform, maybe just declare variables of type `std::basic_string<int>`.

That's the theory. Remember however that `basic_string` has additional type parameters, which take default arguments based on the character type (called `CharT` here):

```
template <typename CharT,
typename Traits = char_traits<CharT>,
typename Alloc = allocator<CharT> >
class basic_string { ... };
```

Now, `allocator<CharT>` will probably Do The Right Thing by default, unless you need to implement your own allocator for your characters.

But `char_traits` takes more work. The `char_traits` template is *declared* but not *defined*. That means there is only

```
template <typename CharT>
struct char_traits
{
    static void foo (type1 x, type2 y);
    ...
};
```

and functions such as `char_traits<CharT>::foo()` are not actually defined anywhere for the general case. The C++ standard permits this, because writing such a definition to fit all possible `CharT`'s cannot be done.

The C++ standard also requires that `char_traits` be specialized for instantiations of `char` and `wchar_t`, and it is these template specializations that permit entities like `basic_string<char, char_traits<char>>` to work.

If you want to use character types other than `char` and `wchar_t`, such as `unsigned char` and `int`, you will need suitable specializations for them. For a time, in earlier versions of GCC, there was a mostly-correct implementation that let programmers be lazy but it broke under many situations, so it was removed. GCC 3.4 introduced a new implementation that mostly works and can be specialized even for `int` and other built-in types.

If you want to use your own special character class, then you have **a lot of work to do**, especially if you wish to use i18n features (facets require traits information but don't have a traits argument).

Another example of how to specialize `char_traits` was given **on the mailing list** and at a later date was put into the file `include/ext/pod_char_traits.h`. We agree that the way it's used with `basic_string` (scroll down to `main()`) doesn't look nice, but that's because **the nice-looking first attempt** turned out to **not be conforming C++**, due to the rule that `CharT` must be a POD. (See how tricky this is?)

7.1.4 Tokenizing

The Standard C (and C++) function `strtok()` leaves a lot to be desired in terms of user-friendliness. It's unintuitive, it destroys the character string on which it operates, and it requires you to handle all the memory problems. But it does let the client code decide what to use to break the string into pieces; it allows you to choose the "whitespace," so to speak.

A C++ implementation lets us keep the good things and fix those annoyances. The implementation here is more intuitive (you only call it once, not in a loop with varying argument), it does not affect the original string at all, and all the memory allocation is handled for you.

It's called `stringtok`, and it's a template function. Sources are as below, in a less-portable form than it could be, to keep this example simple (for example, see the comments on what kind of string it will accept).

```
#include <string>
template <typename Container>
void
```

```

stringtok(Container &container, string const &in,
          const char * const delimiters = " \t\n")
{
    const string::size_type len = in.length();
    string::size_type i = 0;

    while (i < len)
    {
        // Eat leading whitespace
        i = in.find_first_not_of(delimiters, i);
        if (i == string::npos)
            return; // Nothing left but white space

        // Find the end of the token
        string::size_type j = in.find_first_of(delimiters, i);

        // Push token
        if (j == string::npos)
        {
            container.push_back(in.substr(i));
            return;
        }
        else
            container.push_back(in.substr(i, j-i));

        // Set up for next loop
        i = j + 1;
    }
}

```

The author uses a more general (but less readable) form of it for parsing command strings and the like. If you compiled and ran this code using it:

```

std::list<string> ls;
stringtok (ls, " this \t is\t\n a test ");
for (std::list<string>const_iterator i = ls.begin();
     i != ls.end(); ++i)
{
    std::cerr << ':' << (*i) << ":\n";
}

```

You would see this as output:

```

:this:
:is:
:a:
:test:

```

with all the whitespace removed. The original `s` is still available for use, `ls` will clean up after itself, and `ls.size()` will return how many tokens there were.

As always, there is a price paid here, in that `stringtok` is not as fast as `strtok`. The other benefits usually outweigh that, however.

Added February 2001: Mark Wilden pointed out that the standard `std::getline()` function can be used with standard `istreamstreams` to perform tokenizing as well. Build an `istreamstream` from the input text, and then use `std::getline` with varying delimiters (the three-argument signature) to extract tokens into a string.

7.1.5 Shrink to Fit

From GCC 3.4 calling `s.reserve(res)` on a string `s` with `res < s.capacity()` will reduce the string's capacity to `std::max(s.size(), res)`.

This behaviour is suggested, but not required by the standard. Prior to GCC 3.4 the following alternative can be used instead

```
std::string(str.data(), str.size()).swap(str);
```

This is similar to the idiom for reducing a `vector`'s memory usage (see [this FAQ entry](#)) but the regular copy constructor cannot be used because `libstdc++`'s `string` is Copy-On-Write.

In **C++11** mode you can call `s.shrink_to_fit()` to achieve the same effect as `s.reserve(s.size())`.

7.1.6 CString (MFC)

A common lament seen in various newsgroups deals with the Standard `string` class as opposed to the Microsoft Foundation Class called `CString`. Often programmers realize that a standard portable answer is better than a proprietary nonportable one, but in porting their application from a Win32 platform, they discover that they are relying on special functions offered by the `CString` class.

Things are not as bad as they seem. In [this message](#), Joe Buck points out a few very important things:

- The Standard `string` supports all the operations that `CString` does, with three exceptions.
- Two of those exceptions (whitespace trimming and case conversion) are trivial to implement. In fact, we do so on this page.
- The third is `CString::Format`, which allows formatting in the style of `sprintf`. This deserves some mention:

The old `libg++` library had a function called `form()`, which did much the same thing. But for a Standard solution, you should use the `stringstream` classes. These are the bridge between the `iostream` hierarchy and the `string` class, and they operate with regular streams seamlessly because they inherit from the `iostream` hierarchy. An quick example:

```
#include <iostream>
#include <string>
#include <sstream>

string f (string& incoming)      // incoming is "foo N"
{
    istringstream  incoming_stream(incoming);
    string         the_word;
    int            the_number;

    incoming_stream >> the_word      // extract "foo"
                    >> the_number;  // extract N

    ostringstream  output_stream;
    output_stream << "The word was " << the_word
                  << " and 3*N was " << (3*the_number);

    return output_stream.str();
}
```

A serious problem with `CString` is a design bug in its memory allocation. Specifically, quoting from that same message:

`CString` suffers from a common programming error that results in poor performance. Consider the following code:

```
CString n_copies_of (const CString& foo, unsigned n)
{
    CString tmp;
    for (unsigned i = 0; i < n; i++)
        tmp += foo;
    return tmp;
}
```

This function is $O(n^2)$, not $O(n)$. The reason is that each `+=` causes a reallocation and copy of the existing string. Microsoft applications are full of this kind of thing (quadratic performance on tasks that can be done in linear time) -- on the other hand, we should be thankful, as it's created such a big market for high-end ix86 hardware. :-)

If you replace `CString` with `string` in the above function, the performance is $O(n)$.

Joe Buck also pointed out some other things to keep in mind when comparing `CString` and the Standard `string` class:

- `CString` permits access to its internal representation; coders who exploited that may have problems moving to `string`.
- Microsoft ships the source to `CString` (in the files `MFC\SRC\Str{core,ex}.cpp`), so you could fix the allocation bug and rebuild your MFC libraries. Note: *It looks like the `CString` shipped with VC++6.0 has fixed this, although it may in fact have been one of the VC++ SPs that did it.*
- `string` operations like this have $O(n)$ complexity *if the implementors do it correctly*. The `libstdc++` implementors did it correctly. Other vendors might not.
- While parts of the SGI STL are used in `libstdc++`, their `string` class is not. The SGI `string` is essentially `vector<char>` and does not do any reference counting like `libstdc++`'s does. (It is $O(n)$, though.) So if you're thinking about SGI's `string` or `rope` classes, you're now looking at four possibilities: `CString`, the `libstdc++` `string`, the SGI `string`, and the SGI `rope`, and this is all before any allocator or traits customizations! (More choices than you can shake a stick at -- want fries with that?)

Chapter 8

Localization

8.1 Locales

8.1.1 locale

Describes the basic locale object, including nested classes `id`, `facet`, and the reference-counted implementation object, class `_Impl`.

8.1.1.1 Requirements

Class `locale` is non-templated and has two distinct types nested inside of it:

```
class facet 22.1.1.1.2 Class locale::facet
```

Facets actually implement locale functionality. For instance, a facet called `num_punct` is the data object that can be used to query for the thousands separator in the locale.

Literally, a facet is strictly defined:

- Containing the following public data member:

```
static locale::id id;
```

- Derived from another facet:

```
class gnu_codecvt:public std::ctype<user-defined-type>
```

Of interest in this class are the memory management options explicitly specified as an argument to `facet`'s constructor. Each constructor of a facet class takes a `std::size_t __refs` argument: if `__refs == 0`, the facet is deleted when the locale containing it is destroyed. If `__refs == 1`, the facet is not destroyed, even when it is no longer referenced.

```
class id 22.1.1.1.3 - Class locale::id
```

Provides an index for looking up specific facets.

8.1.1.2 Design

The major design challenge is fitting an object-orientated and non-global locale design on top of POSIX and other relevant standards, which include the Single Unix (see X/Open.)

Because C and earlier versions of POSIX fall down so completely, portability is an issue.

8.1.1.3 Implementation

8.1.1.3.1 Interacting with "C" locales

- `locale -a`` displays available locales.

```
af_ZA
ar_AE
ar_AE.utf8
ar_BH
ar_BH.utf8
ar_DZ
ar_DZ.utf8
ar_EG
ar_EG.utf8
ar_IN
ar_IQ
ar_IQ.utf8
ar_JO
ar_JO.utf8
ar_KW
ar_KW.utf8
ar_LB
ar_LB.utf8
ar_LY
ar_LY.utf8
ar_MA
ar_MA.utf8
ar_OM
ar_OM.utf8
ar_QA
ar_QA.utf8
ar_SA
ar_SA.utf8
ar_SD
ar_SD.utf8
ar_SY
ar_SY.utf8
ar_TN
ar_TN.utf8
ar_YE
ar_YE.utf8
be_BY
be_BY.utf8
bg_BG
bg_BG.utf8
br_FR
bs_BA
C
ca_ES
ca_ES@euro
ca_ES.utf8
ca_ES.utf8@euro
cs_CZ
cs_CZ.utf8
cy_GB
da_DK
da_DK.iso885915
da_DK.utf8
de_AT
de_AT@euro
```

```
de_AT.utf8
de_AT.utf8@euro
de_BE
de_BE@euro
de_BE.utf8
de_BE.utf8@euro
de_CH
de_CH.utf8
de_DE
de_DE@euro
de_DE.utf8
de_DE.utf8@euro
de_LU
de_LU@euro
de_LU.utf8
de_LU.utf8@euro
el_GR
el_GR.utf8
en_AU
en_AU.utf8
en_BW
en_BW.utf8
en_CA
en_CA.utf8
en_DK
en_DK.utf8
en_GB
en_GB.iso885915
en_GB.utf8
en_HK
en_HK.utf8
en_IE
en_IE@euro
en_IE.utf8
en_IE.utf8@euro
en_IN
en_NZ
en_NZ.utf8
en_PH
en_PH.utf8
en_SG
en_SG.utf8
en_US
en_US.iso885915
en_US.utf8
en_ZA
en_ZA.utf8
en_ZW
en_ZW.utf8
es_AR
es_AR.utf8
es_BO
es_BO.utf8
es_CL
es_CL.utf8
es_CO
es_CO.utf8
es_CR
es_CR.utf8
es_DO
es_DO.utf8
es_EC
```

```
es_EC.utf8
es_ES
es_ES@euro
es_ES.utf8
es_ES.utf8@euro
es_GT
es_GT.utf8
es_HN
es_HN.utf8
es_MX
es_MX.utf8
es_NI
es_NI.utf8
es_PA
es_PA.utf8
es_PE
es_PE.utf8
es_PR
es_PR.utf8
es_PY
es_PY.utf8
es_SV
es_SV.utf8
es_US
es_US.utf8
es_UY
es_UY.utf8
es_VE
es_VE.utf8
et_EE
et_EE.utf8
eu_ES
eu_ES@euro
eu_ES.utf8
eu_ES.utf8@euro
fa_IR
fi_FI
fi_FI@euro
fi_FI.utf8
fi_FI.utf8@euro
fo_FO
fo_FO.utf8
fr_BE
fr_BE@euro
fr_BE.utf8
fr_BE.utf8@euro
fr_CA
fr_CA.utf8
fr_CH
fr_CH.utf8
fr_FR
fr_FR@euro
fr_FR.utf8
fr_FR.utf8@euro
fr_LU
fr_LU@euro
fr_LU.utf8
fr_LU.utf8@euro
ga_IE
ga_IE@euro
ga_IE.utf8
ga_IE.utf8@euro
```

```
gl_ES
gl_ES@euro
gl_ES.utf8
gl_ES.utf8@euro
gv_GB
gv_GB.utf8
he_IL
he_IL.utf8
hi_IN
hr_HR
hr_HR.utf8
hu_HU
hu_HU.utf8
id_ID
id_ID.utf8
is_IS
is_IS.utf8
it_CH
it_CH.utf8
it_IT
it_IT@euro
it_IT.utf8
it_IT.utf8@euro
iw_IL
iw_IL.utf8
ja_JP.eucjp
ja_JP.utf8
ka_GE
kl_GL
kl_GL.utf8
ko_KR.euckr
ko_KR.utf8
kw_GB
kw_GB.utf8
lt_LT
lt_LT.utf8
lv_LV
lv_LV.utf8
mi_NZ
mk_MK
mk_MK.utf8
mr_IN
ms_MY
ms_MY.utf8
mt_MT
mt_MT.utf8
nl_BE
nl_BE@euro
nl_BE.utf8
nl_BE.utf8@euro
nl_NL
nl_NL@euro
nl_NL.utf8
nl_NL.utf8@euro
nn_NO
nn_NO.utf8
no_NO
no_NO.utf8
oc_FR
pl_PL
pl_PL.utf8
POSIX
```

```
pt_BR
pt_BR.utf8
pt_PT
pt_PT@euro
pt_PT.utf8
pt_PT.utf8@euro
ro_RO
ro_RO.utf8
ru_RU
ru_RU.koi8r
ru_RU.utf8
ru_UA
ru_UA.utf8
se_NO
sk_SK
sk_SK.utf8
sl_SI
sl_SI.utf8
sq_AL
sq_AL.utf8
sr_YU
sr_YU@cyrillic
sr_YU.utf8
sr_YU.utf8@cyrillic
sv_FI
sv_FI@euro
sv_FI.utf8
sv_FI.utf8@euro
sv_SE
sv_SE.iso885915
sv_SE.utf8
ta_IN
te_IN
tg_TJ
th_TH
th_TH.utf8
tl_PH
tr_TR
tr_TR.utf8
uk_UA
uk_UA.utf8
ur_PK
uz_UZ
vi_VN
vi_VN.tcvn
wa_BE
wa_BE@euro
yi_US
zh_CN
zh_CN.gb18030
zh_CN.gbk
zh_CN.utf8
zh_HK
zh_HK.utf8
zh_TW
zh_TW.euctw
zh_TW.utf8
```

- ``locale`` displays environmental variables that impact how `locale("")` will be deduced.

```
LANG=en_US
```

```
LC_CTYPE="en_US"
LC_NUMERIC="en_US"
LC_TIME="en_US"
LC_COLLATE="en_US"
LC_MONETARY="en_US"
LC_MESSAGES="en_US"
LC_PAPER="en_US"
LC_NAME="en_US"
LC_ADDRESS="en_US"
LC_TELEPHONE="en_US"
LC_MEASUREMENT="en_US"
LC_IDENTIFICATION="en_US"
LC_ALL=
```

From Josuttis, p. 697-698, which says, that "there is only *one* relation (of the C++ locale mechanism) to the C locale mechanism: the global C locale is modified if a named C++ locale object is set as the global locale" (emphasis Paolo), that is:

```
std::locale::global(std::locale(""));
```

affects the C functions as if the following call was made:

```
std::setlocale(LC_ALL, "");
```

On the other hand, there is *no* vice versa, that is, calling `setlocale` has *no* whatsoever on the C++ locale mechanism, in particular on the working of `locale("")`, which constructs the locale object from the environment of the running program, that is, in practice, the set of `LC_ALL`, `LANG`, etc. variable of the shell.

8.1.1.4 Future

- Locale initialization: at what point does `_S_classic`, `_S_global` get initialized? Can named locales assume this initialization has already taken place?
- Document how named locales error check when filling data members. I.e., a `fr_FR` locale that doesn't have `numpunct::truename()`: does it use "true"? Or is it a blank string? What's the convention?
- Explain how locale aliasing happens. When does "de_DE" use "de" information? What is the rule for locales composed of just an ISO language code (say, "de") and locales with both an ISO language code and ISO country code (say, "de_DE").
- What should non-required facet instantiations do? If the generic implementation is provided, then how to end-users provide specializations?

8.1.1.5 Bibliography

- [19] Roland McGrathUlrich Drepper, Copyright © 2007 FSF, Chapters 6 Character Set Handling and 7 Locales and Internationalization .
- [20] Ulrich Drepper, Copyright © 2002 .
- [21] , Copyright © 1998 ISO.
- [22] , Copyright © 1999 ISO.
- [23] *System Interface Definitions, Issue 7 (IEEE Std. 1003.1-2008)* , Copyright © 2008 The Open Group/The Institute of Electrical and Electronics Engineers, Inc. .
- [24] Bjarne Stroustrup, Copyright © 2000 Addison Wesley, Inc., Appendix D, Addison Wesley .
- [25] Angelika LangerKlaus Kreft, *Advanced Programmer's Guide and Reference* , Copyright © 2000 Addison Wesley Longman, Inc., Addison Wesley Longman .

8.2 Facets

8.2.1 ctype

8.2.1.1 Implementation

8.2.1.1.1 Specializations

For the required specialization `codecvt<wchar_t, char, mbstate_t>`, conversions are made between the internal character set (always UCS4 on GNU/Linux) and whatever the currently selected locale for the `LC_CTYPE` category implements.

The two required specializations are implemented as follows:

```
ctype<char>
```

This is simple specialization. Implementing this was a piece of cake.

```
ctype<wchar_t>
```

This specialization, by specifying all the template parameters, pretty much ties the hands of implementors. As such, the implementation is straightforward, involving `mcsrtombs` for the conversions between `char` to `wchar_t` and `wcsrtombs` for conversions between `wchar_t` and `char`.

Neither of these two required specializations deals with Unicode characters.

8.2.1.2 Future

- How to deal with the global locale issue?
- How to deal with types other than `char`, `wchar_t`?
- Overlap between `codecvt/ctype`: narrow/widen
- mask typedef in `codecvt_base`, argument types in `codecvt`. what is know about this type?
- Why mask* argument in `codecvt`?
- Can this be made (more) generic? is there a simple way to straighten out the configure-time mess that is a by-product of this class?
- Get the `ctype<wchar_t>::mask` stuff under control. Need to make some kind of static table, and not do lookup every time somebody hits the `do_is...` functions. Too bad we can't just redefine mask for `ctype<wchar_t>`
- Rename abstract base class. See if just smash-overriding is a better approach. Clarify, add sanity to naming.

8.2.1.3 Bibliography

- [26] Roland McGrathUlrich Drepper, Copyright © 2007 FSF, Chapters 6 Character Set Handling and 7 Locales and Internationalization.
- [27] Ulrich Drepper, Copyright © 2002 .
- [28] , Copyright © 1998 ISO.
- [29] , Copyright © 1999 ISO.
- [30] *The Open Group Base Specifications, Issue 6 (IEEE Std. 1003.1-2004)* , Copyright © 1999 The Open Group/The Institute of Electrical and Electronics Engineers, Inc..
- [31] Bjarne Stroustrup, Copyright © 2000 Addison Wesley, Inc., Appendix D, Addison Wesley .
- [32] Angelika LangerKlaus Kreft, *Advanced Programmer's Guide and Reference* , Copyright © 2000 Addison Wesley Longman, Inc., Addison Wesley Longman .

8.2.2 codecvt

The standard class `codecvt` attempts to address conversions between different character encoding schemes. In particular, the standard attempts to detail conversions between the implementation-defined wide characters (hereafter referred to as `wchar_t`) and the standard type `char` that is so beloved in classic “C” (which can now be referred to as narrow characters.) This document attempts to describe how the GNU `libstdc++` implementation deals with the conversion between wide and narrow characters, and also presents a framework for dealing with the huge number of other encodings that `iconv` can convert, including Unicode and UTF8. Design issues and requirements are addressed, and examples of correct usage for both the required specializations for wide and narrow characters and the implementation-provided extended functionality are given.

8.2.2.1 Requirements

Around page 425 of the C++ Standard, this charming heading comes into view:

22.2.1.5 - Template class `codecvt`

The text around the `codecvt` definition gives some clues:

-1- The class `codecvt<internT, externT, stateT>` is for use when converting from one codeset to another, such as from wide characters to multibyte characters, between wide character encodings such as Unicode and EUC.

Hmm. So, in some unspecified way, Unicode encodings and translations between other character sets should be handled by this class.

-2- The `stateT` argument selects the pair of codesets being mapped between.

Ah ha! Another clue...

-3- The instantiations required in the Table 51 (`lib.locale.category`), namely `codecvt<wchar_t, char, mbstate_t>` and `codecvt<char, char, mbstate_t>`, convert the implementation-defined native character set. `codecvt<char, char, mbstate_t>` implements a degenerate conversion; it does not convert at all. `codecvt<wchar_t, char, mbstate_t>` converts between the native character sets for tiny and wide characters. Instantiations on `mbstate_t` perform conversion between encodings known to the library implementor. Other encodings can be converted by specializing on a user-defined `stateT` type. The `stateT` object can contain any state that is useful to communicate to or from the specialized `do_convert` member.

At this point, a couple points become clear:

One: The standard clearly implies that attempts to add non-required (yet useful and widely used) conversions need to do so through the third template parameter, `stateT`.

Two: The required conversions, by specifying `mbstate_t` as the third template parameter, imply an implementation strategy that is mostly (or wholly) based on the underlying C library, and the functions `mbsrtombs` and `wcsrtombs` in particular.

8.2.2.2 Design

8.2.2.2.1 `wchar_t` Size

The simple implementation detail of `wchar_t`'s size seems to repeatedly confound people. Many systems use a two byte, unsigned integral type to represent wide characters, and use an internal encoding of Unicode or UCS2. (See AIX, Microsoft NT, Java, others.) Other systems, use a four byte, unsigned integral type to represent wide characters, and use an internal encoding of UCS4. (GNU/Linux systems using `glibc`, in particular.) The C programming language (and thus C++) does not specify a specific size for the type `wchar_t`.

Thus, portable C++ code cannot assume a byte size (or endianness) either.

8.2.2.2.2 Support for Unicode

Probably the most frequently asked question about code conversion is: "So dudes, what's the deal with Unicode strings?" The dude part is optional, but apparently the usefulness of Unicode strings is pretty widely appreciated. The Unicode character set (and useful encodings like UTF-8, UCS-4, ISO 8859-10, etc etc etc) were not mentioned in the first C++ standard. (The 2011 standard added support for string literals with different encodings and some library facilities for converting between encodings, but the notes below have not been updated to reflect that.)

A couple of comments:

The thought that all one needs to convert between two arbitrary codesets is two types and some kind of state argument is unfortunate. In particular, encodings may be stateless. The naming of the third parameter as stateT is unfortunate, as what is really needed is some kind of generalized type that accounts for the issues that abstract encodings will need. The minimum information that is required includes:

- Identifiers for each of the codesets involved in the conversion. For example, using the iconv family of functions from the Single Unix Specification (what used to be called X/Open) hosted on the GNU/Linux operating system allows bi-directional mapping between far more than the following tantalizing possibilities:

(An edited list taken from ``iconv --list`` on a Red Hat 6.2/Intel system:

```
8859_1, 8859_9, 10646-1:1993, 10646-1:1993/UCS4, ARABIC, ARABIC7,
ASCII, EUC-CN, EUC-JP, EUC-KR, EUC-TW, GREEK-CClcode, GREEK, GREEK7-OLD,
GREEK7, GREEK8, HEBREW, ISO-8859-1, ISO-8859-2, ISO-8859-3,
ISO-8859-4, ISO-8859-5, ISO-8859-6, ISO-8859-7, ISO-8859-8,
ISO-8859-9, ISO-8859-10, ISO-8859-11, ISO-8859-13, ISO-8859-14,
ISO-8859-15, ISO-10646, ISO-10646/UCS2, ISO-10646/UCS4,
ISO-10646/UTF-8, ISO-10646/UTF8, SHIFT-JIS, SHIFT_JIS, UCS-2, UCS-4,
UCS2, UCS4, UNICODE, UNICODEBIG, UNICODELlcodeLE, US-ASCII, US, UTF-8,
UTF-16, UTF8, UTF16).
```

For iconv-based implementations, string literals for each of the encodings (i.e. "UCS-2" and "UTF-8") are necessary, although for other, non-iconv implementations a table of enumerated values or some other mechanism may be required.

- Maximum length of the identifying string literal.
- Some encodings require explicit endian-ness. As such, some kind of endian marker or other byte-order marker will be necessary. See "Footnotes for C/C++ developers" in Haible for more information on UCS-2/Unicode endian issues. (Summary: big endian seems most likely, however implementations, most notably Microsoft, vary.)
- Types representing the conversion state, for conversions involving the machinery in the "C" library, or the conversion descriptor, for conversions using iconv (such as the type iconv_t.) Note that the conversion descriptor encodes more information than a simple encoding state type.
- Conversion descriptors for both directions of encoding. (i.e., both UCS-2 to UTF-8 and UTF-8 to UCS-2.)
- Something to indicate if the conversion requested is valid.
- Something to represent if the conversion descriptors are valid.
- Some way to enforce strict type checking on the internal and external types. As part of this, the size of the internal and external types will need to be known.

8.2.2.2.3 Other Issues

In addition, multi-threaded and multi-locale environments also impact the design and requirements for code conversions. In particular, they affect the required specialization `codecv<wchar_t, char, mbstate_t>` when implemented using standard "C" functions.

Three problems arise, one big, one of medium importance, and one small.

First, the small: `mcsrtombs` and `wcsrtombs` may not be multithread-safe on all systems required by the GNU tools. For GNU/Linux and `glibc`, this is not an issue.

Of medium concern, in the grand scope of things, is that the functions used to implement this specialization work on null-terminated strings. Buffers, especially file buffers, may not be null-terminated, thus giving conversions that end prematurely or are otherwise incorrect. Yikes!

The last, and fundamental problem, is the assumption of a global locale for all the "C" functions referenced above. For something like C++ iostreams (where `codecvt` is explicitly used) the notion of multiple locales is fundamental. In practice, most users may not run into this limitation. However, as a quality of implementation issue, the GNU C++ library would like to offer a solution that allows multiple locales and or simultaneous usage with computationally correct results. In short, `libstdc++` is trying to offer, as an option, a high-quality implementation, damn the additional complexity!

For the required specialization `codecvt<wchar_t, char, mbstate_t>`, conversions are made between the internal character set (always UCS4 on GNU/Linux) and whatever the currently selected locale for the `LC_CTYPE` category implements.

8.2.2.3 Implementation

The two required specializations are implemented as follows:

```
codecvt<char, char, mbstate_t>
```

This is a degenerate (i.e., does nothing) specialization. Implementing this was a piece of cake.

```
codecvt<char, wchar_t, mbstate_t>
```

This specialization, by specifying all the template parameters, pretty much ties the hands of implementors. As such, the implementation is straightforward, involving `mcsrtombs` for the conversions between `char` to `wchar_t` and `wcsrtombs` for conversions between `wchar_t` and `char`.

Neither of these two required specializations deals with Unicode characters. As such, `libstdc++` implements a partial specialization of the `codecvt` class with an `iconv` wrapper class, `encoding_state` as the third template parameter.

This implementation should be standards conformant. First of all, the standard explicitly points out that instantiations on the third template parameter, `stateT`, are the proper way to implement non-required conversions. Second of all, the standard says (in Chapter 17) that partial specializations of required classes are A-OK. Third of all, the requirements for the `stateT` type elsewhere in the standard (see 21.1.2 traits typedefs) only indicate that this type be copy constructible.

As such, the type `encoding_state` is defined as a non-templated, POD type to be used as the third type of a `codecvt` instantiation. This type is just a wrapper class for `iconv`, and provides an easy interface to `iconv` functionality.

There are two constructors for `encoding_state`:

```
encoding_state() : __in_desc(0), __out_desc(0)
```

This default constructor sets the internal encoding to some default (currently UCS4) and the external encoding to whatever is returned by `nl_langinfo(CODESET)`.

```
encoding_state(const char* __int, const char* __ext)
```

This constructor takes as parameters string literals that indicate the desired internal and external encoding. There are no defaults for either argument.

One of the issues with `iconv` is that the string literals identifying conversions are not standardized. Because of this, the thought of mandating and/or enforcing some set of pre-determined valid identifiers seems iffy: thus, a more practical (and non-migraine inducing) strategy was implemented: end-users can specify any string (subject to a pre-determined length qualifier, currently 32 bytes) for encodings. It is up to the user to make sure that these strings are valid on the target system.

```
void _M_init()
```

Strangely enough, this member function attempts to open conversion descriptors for a given `encoding_state` object. If the conversion descriptors are not valid, the conversion descriptors returned will not be valid and the resulting calls to the `codecvt` conversion functions will return error.

```
bool _M_good()
```

Provides a way to see if the given `encoding_state` object has been properly initialized. If the string literals describing the desired internal and external encoding are not valid, initialization will fail, and this will return false. If the internal and external encodings are valid, but `iconv_open` could not allocate conversion descriptors, this will also return false. Otherwise, the object is ready to convert and will return true.

```
encoding_state(const encoding_state&)
```

As `iconv` allocates memory and sets up conversion descriptors, the copy constructor can only copy the member data pertaining to the internal and external code conversions, and not the conversion descriptors themselves.

Definitions for all the required `codecvt` member functions are provided for this specialization, and usage of `codecvt<internal character type, external character type, encoding_state>` is consistent with other `codecvt` usage.

8.2.2.4 Use

A conversion involving a string literal.

```
typedef codecvt_base::result          result;
typedef unsigned short                unicode_t;
typedef unicode_t                    int_type;
typedef char                          ext_type;
typedef encoding_state                state_type;
typedef codecvt<int_type, ext_type, state_type> unicode_codecvt;

const ext_type*      e_lit = "black pearl jasmine tea";
int                 size = strlen(e_lit);
int_type            i_lit_base[24] =
{ 25088, 27648, 24832, 25344, 27392, 8192, 28672, 25856, 24832, 29184,
  27648, 8192, 27136, 24832, 29440, 27904, 26880, 28160, 25856, 8192, 29696,
  25856, 24832, 2560
};
const int_type*      i_lit = i_lit_base;
const ext_type*      efrom_next;
const int_type*      ifrom_next;
ext_type*            e_arr = new ext_type[size + 1];
ext_type*            eto_next;
int_type*            i_arr = new int_type[size + 1];
int_type*            ito_next;

// construct a locale object with the specialized facet.
locale               loc(locale::classic(), new unicode_codecvt);
// sanity check the constructed locale has the specialized facet.
VERIFY( has_facet<unicode_codecvt>(loc) );
const unicode_codecvt& cvt = use_facet<unicode_codecvt>(loc);
// convert between const char* and unicode strings
unicode_codecvt::state_type state01("UNICODE", "ISO_8859-1");
initialize_state(state01);
result r1 = cvt.in(state01, e_lit, e_lit + size, efrom_next,
  i_arr, i_arr + size, ito_next);
VERIFY( r1 == codecvt_base::ok );
VERIFY( !int_traits::compare(i_arr, i_lit, size) );
VERIFY( efrom_next == e_lit + size );
VERIFY( ito_next == i_arr + size );
```

8.2.2.5 Future

- a. things that are sketchy, or remain unimplemented: `do_encoding`, `max_length` and `length` member functions are only weakly implemented. I have no idea how to do this correctly, and in a generic manner. Nathan?
- b. conversions involving `std::string`

- how should operators != and == work for string of different/same encoding?
- what is equal? A byte by byte comparison or an encoding then byte comparison?
- conversions between narrow, wide, and unicode strings
- c. conversions involving std::filebuf and std::ostream
 - how to initialize the state object in a standards-conformant manner?
 - how to synchronize the "C" and "C++" conversion information?
 - wchar_t/char internal buffers and conversions between internal/external buffers?

8.2.2.6 Bibliography

- [33] Roland McGrathUlrich Drepper, Copyright © 2007 FSF, Chapters 6 Character Set Handling and 7 Locales and Internationalization .
- [34] Ulrich Drepper, Copyright © 2002 .
- [35] , Copyright © 1998 ISO.
- [36] , Copyright © 1999 ISO.
- [37] *System Interface Definitions, Issue 7 (IEEE Std. 1003.1-2008)* , Copyright © 2008 The Open Group/The Institute of Electrical and Electronics Engineers, Inc. .
- [38] Bjarne Stroustrup, Copyright © 2000 Addison Wesley, Inc., Appendix D, Addison Wesley .
- [39] Angelika LangerKlaus Kreft, Advanced Programmer's Guide and Reference , Copyright © 2000 Addison Wesley Longman, Inc., Addison Wesley Longman .
- [40] Clive Feather, *A brief description of Normative Addendum 1* , Extended Character Sets.
- [41] Bruno Haible, *The Unicode HOWTO*
- [42] Markus Khun, *UTF-8 and Unicode FAQ for Unix/Linux*

8.2.3 messages

The std::messages facet implements message retrieval functionality equivalent to Java's java.text.MessageFormat .using either GNU gettext or IEEE 1003.1-200 functions.

8.2.3.1 Requirements

The std::messages facet is probably the most vaguely defined facet in the standard library. It's assumed that this facility was built into the standard library in order to convert string literals from one locale to the other. For instance, converting the "C" locale's `const char* c = "please"` to a German-localized "bitte" during program execution.

22.2.7.1 - Template class messages [lib.locale.messages]

This class has three public member functions, which directly correspond to three protected virtual member functions.

The public member functions are:

```
catalog open(const string&, const locale&) const
string_type get(catalog, int, int, const string_type&) const
void close(catalog) const
```

While the virtual functions are:

```
catalog do_open(const string&, const locale&) const
```

-1- Returns: A value that may be passed to `get()` to retrieve a message, from the message catalog identified by the string name according to an implementation-defined mapping. The result can be used until it is passed to `close()`. Returns a value less than 0 if no such catalog can be opened.

```
string_type do_get(catalog, int, int, const string_type&) const
```

-3- Requires: A catalog `cat` obtained from `open()` and not yet closed. -4- Returns: A message identified by arguments `set`, `msgid`, and `dfault`, according to an implementation-defined mapping. If no such message can be found, returns `dfault`.

```
void do_close(catalog) const
```

-5- Requires: A catalog `cat` obtained from `open()` and not yet closed. -6- Effects: Releases unspecified resources associated with `cat`. -7- Notes: The limit on such resources, if any, is implementation-defined.

8.2.3.2 Design

A couple of notes on the standard.

First, why is `messages_base::catalog` specified as a typedef to `int`? This makes sense for implementations that use `catopen` and define `nl_catd` as `int`, but not for others. Fortunately, it's not heavily used and so only a minor irritant. This has been reported as a possible defect in the standard (LWG 2028).

Second, by making the member functions `const`, it is impossible to save state in them. Thus, storing away information used in the 'open' member function for use in 'get' is impossible. This is unfortunate.

The 'open' member function in particular seems to be oddly designed. The signature seems quite peculiar. Why specify a `const string&` argument, for instance, instead of just `const char*`? Or, why specify a `const locale&` argument that is to be used in the 'get' member function? How, exactly, is this locale argument useful? What was the intent? It might make sense if a locale argument was associated with a given default message string in the 'open' member function, for instance. Quite murky and unclear, on reflection.

Lastly, it seems odd that messages, which explicitly require code conversion, don't use the `codecvt` facet. Because the messages facet has only one template parameter, it is assumed that `cctype`, and not `codecvt`, is to be used to convert between character sets.

It is implicitly assumed that the locale for the default message string in 'get' is in the "C" locale. Thus, all source code is assumed to be written in English, so translations are always from "en_US" to other, explicitly named locales.

8.2.3.3 Implementation

8.2.3.3.1 Models

This is a relatively simple class, on the face of it. The standard specifies very little in concrete terms, so generic implementations that are conforming yet do very little are the norm. Adding functionality that would be useful to programmers and comparable to Java's `java.text.MessageFormat` takes a bit of work, and is highly dependent on the capabilities of the underlying operating system.

Three different mechanisms have been provided, selectable via configure flags:

- generic

This model does very little, and is what is used by default.

- gnu

The gnu model is complete and fully tested. It's based on the GNU `gettext` package, which is part of `glibc`. It uses the functions `textdomain`, `bindtextdomain`, `gettext` to implement full functionality. Creating message catalogs is a relatively straight-forward process and is lightly documented below, and fully documented in `gettext`'s distributed documentation.

- `ieee_1003.1-200x`

This is a complete, though untested, implementation based on the IEEE standard. The functions `catopen`, `catgets`, `catclose` are used to retrieve locale-specific messages given the appropriate message catalogs that have been constructed for their use. Note, the script `po2msg.sed` that is part of the `gettext` distribution can convert `gettext` catalogs into catalogs that `catopen` can use.

A new, standards-conformant non-virtual member function signature was added for `'open'` so that a directory could be specified with a given message catalog. This simplifies calling conventions for the `gnu` model.

8.2.3.3.2 The GNU Model

The messages facet, because it is retrieving and converting between characters sets, depends on the `ctype` and perhaps the `codecvt` facet in a given locale. In addition, underlying "C" library locale support is necessary for more than just the `LC_MESSAGES` mask: `LC_CTYPE` is also necessary. To avoid any unpleasantness, all bits of the "C" mask (i.e. `LC_ALL`) are set before retrieving messages.

Making the message catalogs can be initially tricky, but become quite simple with practice. For complete info, see the `gettext` documentation. Here's an idea of what is required:

- Make a source file with the required string literals that need to be translated. See `intl/string_literals.cc` for an example.

- Make initial catalog (see "4 Making the PO Template File" from the `gettext` docs).

```
xgettext --c++ --debug string_literals.cc -o libstdc++.pot
```

- Make language and country-specific locale catalogs.

```
cp libstdc++.pot fr_FR.po
cp libstdc++.pot de_DE.po
```

- Edit localized catalogs in `emacs` so that strings are translated.

```
emacs fr_FR.po
```

- Make the binary `mo` files.

```
msgfmt fr_FR.po -o fr_FR.mo
msgfmt de_DE.po -o de_DE.mo
```

- Copy the binary files into the correct directory structure.

```
cp fr_FR.mo (dir)/fr_FR/LC_MESSAGES/libstdc++.mo
cp de_DE.mo (dir)/de_DE/LC_MESSAGES/libstdc++.mo
```

- Use the new message catalogs.

```
locale loc_de("de_DE");
use_facet<messages<char>>(loc_de).open("libstdc++", locale(), dir);
```

8.2.3.4 Use

A simple example using the GNU model of message conversion.

```
#include <iostream>
#include <locale>
using namespace std;

void test01()
{
    typedef messages<char>::catalog catalog;
```

```

const char* dir =
"/mnt/egcs/build/i686-pc-linux-gnu/libstdc++/po/share/locale";
const locale loc_de("de_DE");
const messages<char>& mssg_de = use_facet<messages<char> >(loc_de);

catalog cat_de = mssg_de.open("libstdc++", loc_de, dir);
string s01 = mssg_de.get(cat_de, 0, 0, "please");
string s02 = mssg_de.get(cat_de, 0, 0, "thank you");
cout << "please in german:" << s01 << '\n';
cout << "thank you in german:" << s02 << '\n';
mssg_de.close(cat_de);
}

```

8.2.3.5 Future

- Things that are sketchy, or remain unimplemented:
 - `_M_convert_from_char`, `_M_convert_to_char` are in flux, depending on how the library ends up doing character set conversions. It might not be possible to do a real character set based conversion, due to the fact that the template parameter for `messages` is not enough to instantiate the `codecvt` facet (1 supplied, need at least 2 but would prefer 3).
 - There are issues with `gettext` needing the global locale set to extract a message. This dependence on the global locale makes the current "gnu" model non MT-safe. Future versions of `glibc`, i.e. `glibc 2.3.x` will fix this, and the C++ library bits are already in place.
- Development versions of the GNU "C" library, `glibc 2.3` will allow a more efficient, MT implementation of `std::messages`, and will allow the removal of the `_M_name_messages` data member. If this is done, it will change the library ABI. The C++ parts to support `glibc 2.3` have already been coded, but are not in use: once this version of the "C" library is released, the marked parts of the `messages` implementation can be switched over to the new "C" library functionality.
- At some point in the near future, `std::numpunct` will probably use `std::messages` facilities to implement `truename/falsename` correctly. This is currently not done, but entries in `libstdc++.pot` have already been made for "true" and "false" string literals, so all that remains is the `std::numpunct` coding and the `configure/make` hassles to make the installed library search its own catalog. Currently the `libstdc++.mo` catalog is only searched for the testsuite cases involving `messages` members.
- The following member functions:

```

catalog open(const basic_string<char>& __s, const locale& __loc) const
catalog open(const basic_string<char>&, const locale&, const char*) const;

```

Don't actually return a "value less than 0 if no such catalog can be opened" as required by the standard in the "gnu" model. As of this writing, it is unknown how to query to see if a specified message catalog exists using the `gettext` package.

8.2.3.6 Bibliography

- [43] Roland McGrathUlrich Drepper, Copyright © 2007 FSF, Chapters 6 Character Set Handling, and 7 Locales and Internationalization .
- [44] Ulrich Drepper, Copyright © 2002 .
- [45] , Copyright © 1998 ISO.
- [46] , Copyright © 1999 ISO.
- [47] *System Interface Definitions, Issue 7 (IEEE Std. 1003.1-2008)* , Copyright © 2008 The Open Group/The Institute of Electrical and Electronics Engineers, Inc. .
- [48] Bjarne Stroustrup, Copyright © 2000 Addison Wesley, Inc., Appendix D, Addison Wesley .
- [49] Angelika LangerKlaus Kreft, *Advanced Programmer's Guide and Reference* , Copyright © 2000 Addison Wesley Longman, Inc., Addison Wesley Longman .

-
- [50] *API Specifications, Java Platform* , java.util.Properties, java.text.MessageFormat, java.util.Locale, java.util.ResourceBundle .
- [51] *GNU gettext tools, version 0.10.38, Native Language Support Library and Tools.*
-

Chapter 9

Containers

9.1 Sequences

9.1.1 list

9.1.1.1 list::size() is O(n)

Yes it is, and that was okay until the 2011 edition of the C++ standard. In future GCC will change it to O(1) but O(N) was a decision that we preserved when we imported SGI's STL implementation. The following is quoted from [their FAQ](#):

The `size()` member function, for `list` and `slist`, takes time proportional to the number of elements in the list. This was a deliberate tradeoff. The only way to get a constant-time `size()` for linked lists would be to maintain an extra member variable containing the list's size. This would require taking extra time to update that variable (it would make `splice()` a linear time operation, for example), and it would also make the list larger. Many list algorithms don't require that extra word (algorithms that do require it might do better with vectors than with lists), and, when it is necessary to maintain an explicit size count, it's something that users can do themselves.

This choice is permitted by the C++ standard. The standard says that `size()` "should" be constant time, and "should" does not mean the same thing as "shall". This is the officially recommended ISO wording for saying that an implementation is supposed to do something unless there is a good reason not to.

One implication of linear time `size()`: you should never write

```
if (L.size() == 0)
    ...
```

Instead, you should write

```
if (L.empty())
    ...
```

9.2 Associative

9.2.1 Insertion Hints

Section [23.1.2], Table 69, of the C++ standard lists this function for all of the associative containers (`map`, `set`, etc):

```
a.insert(p,t);
```

where `p` is an iterator into the container `a`, and `t` is the item to insert. The standard says that “`t` is inserted as close as possible to the position just prior to `p`.” (Library DR #233 addresses this topic, referring to [N1780](#). Since version 4.2 GCC implements the resolution to DR 233, so that insertions happen as close as possible to the hint. For earlier releases the hint was only used as described below.

Here we’ll describe how the hinting works in the `libstdc++` implementation, and what you need to do in order to take advantage of it. (Insertions can change from logarithmic complexity to amortized constant time, if the hint is properly used.) Also, since the current implementation is based on the SGI STL one, these points may hold true for other library implementations also, since the HP/SGI code is used in a lot of places.

In the following text, the phrases *greater than* and *less than* refer to the results of the strict weak ordering imposed on the container by its comparison object, which defaults to (basically) “`<`”. Using those phrases is semantically sloppy, but I didn’t want to get bogged down in syntax. I assume that if you are intelligent enough to use your own comparison objects, you are also intelligent enough to assign “greater” and “lesser” their new meanings in the next paragraph. *grin*

If the `hint` parameter (`p` above) is equivalent to:

- `begin()`, then the item being inserted should have a key less than all the other keys in the container. The item will be inserted at the beginning of the container, becoming the new entry at `begin()`.
- `end()`, then the item being inserted should have a key greater than all the other keys in the container. The item will be inserted at the end of the container, becoming the new entry before `end()`.
- neither `begin()` nor `end()`, then: Let `h` be the entry in the container pointed to by `hint`, that is, `h == *hint`. Then the item being inserted should have a key less than that of `h`, and greater than that of the item preceding `h`. The new item will be inserted between `h` and `h`’s predecessor.

For `multimap` and `multiset`, the restrictions are slightly looser: “greater than” should be replaced by “not less than” and “less than” should be replaced by “not greater than.” (Why not replace greater with greater-than-or-equal-to? You probably could in your head, but the mathematicians will tell you that it isn’t the same thing.)

If the conditions are not met, then the hint is not used, and the insertion proceeds as if you had called `a.insert(t)` instead. (Note that GCC releases prior to 3.0.2 had a bug in the case with `hint == begin()` for the `map` and `set` classes. You should not use a hint argument in those releases.)

This behavior goes well with other containers’ `insert()` functions which take an iterator: if used, the new item will be inserted before the iterator passed as an argument, same as the other containers.

Note also that the hint in this implementation is a one-shot. The older insertion-with-hint routines check the immediately surrounding entries to ensure that the new item would in fact belong there. If the hint does not point to the correct place, then no further local searching is done; the search begins from scratch in logarithmic time.

9.2.2 bitset

9.2.2.1 Size Variable

No, you cannot write code of the form

```
#include <bitset>

void foo (size_t n)
{
    std::bitset<n>    bits;
    ....
}
```

because `n` must be known at compile time. Your compiler is correct; it is not a bug. That’s the way templates work. (Yes, it *is* a feature.)

There are a couple of ways to handle this kind of thing. Please consider all of them before passing judgement. They include, in no particular order:

- A very large `N` in `bitset<N>`.
- A `container<bool>`.
- Extremely weird solutions.

A very large `N` in `bitset<N>`. It has been pointed out a few times in newsgroups that `N` bits only takes up $(N/8)$ bytes on most systems, and division by a factor of eight is pretty impressive when speaking of memory. Half a megabyte given over to a `bitset` (recall that there is zero space overhead for housekeeping info; it is known at compile time exactly how large the set is) will hold over four million bits. If you're using those bits as status flags (e.g., "changed"/"unchanged" flags), that's a *lot* of state.

You can then keep track of the "maximum bit used" during some testing runs on representative data, make note of how many of those bits really need to be there, and then reduce `N` to a smaller number. Leave some extra space, of course. (If you plan to write code like the incorrect example above, where the `bitset` is a local variable, then you may have to talk your compiler into allowing that much stack space; there may be zero space overhead, but it's all allocated inside the object.)

A `container<bool>`. The Committee made provision for the space savings possible with that $(N/8)$ usage previously mentioned, so that you don't have to do wasteful things like `Container<char>` or `Container<short int>`. Specifically, `vector<bool>` is required to be specialized for that space savings.

The problem is that `vector<bool>` doesn't behave like a normal vector anymore. There have been journal articles which discuss the problems (the ones by Herb Sutter in the May and July/August 1999 issues of C++ Report cover it well). Future revisions of the ISO C++ Standard will change the requirement for `vector<bool>` specialization. In the meantime, `deque<bool>` is recommended (although its behavior is sane, you probably will not get the space savings, but the allocation scheme is different than that of `vector`).

Extremely weird solutions. If you have access to the compiler and linker at runtime, you can do something insane, like figuring out just how many bits you need, then writing a temporary source code file. That file contains an instantiation of `bitset` for the required number of bits, inside some wrapper functions with unchanging signatures. Have your program then call the compiler on that file using Position Independent Code, then open the newly-created object file and load those wrapper functions. You'll have an instantiation of `bitset<N>` for the exact `N` that you need at the time. Don't forget to delete the temporary files. (Yes, this *can* be, and *has been*, done.)

This would be the approach of either a visionary genius or a raving lunatic, depending on your programming and management style. Probably the latter.

Which of the above techniques you use, if any, are up to you and your intended application. Some time/space profiling is indicated if it really matters (don't just guess). And, if you manage to do anything along the lines of the third category, the author would love to hear from you...

Also note that the implementation of `bitset` used in `libstdc++` has [some extensions](#).

9.2.2.2 Type String

Bitmasks do not take `char*` nor `const char*` arguments in their constructors. This is something of an accident, but you can read about the problem: follow the library's "Links" from the homepage, and from the C++ information "defect reflector" link, select the library issues list. Issue number 116 describes the problem.

For now you can simply make a temporary string object using the constructor expression:

```
std::bitset<5> b ( std::string(10110) );
```

instead of

```
std::bitset<5> b ( 10110 ); // invalid
```

9.3 Unordered Associative

9.3.1 Insertion Hints

Here is how the hinting works in the libstdc++ implementation of unordered containers, and the rationale behind this behavior.

In the following text, the phrase *equivalent* to refer to the result of the invocation of the equal predicate imposed on the container by its `key_equal` object, which defaults to (basically) “==”.

Unordered containers can be seen as a `std::vector` of `std::forward_list`. The `std::vector` represents the buckets and each `std::forward_list` is the list of nodes belonging to the same bucket. When inserting an element in such a data structure we first need to compute the element hash code to find the bucket to insert the element to, the second step depends on the uniqueness of elements in the container.

In the case of `std::unordered_set` and `std::unordered_map` you need to look through all bucket’s elements for an equivalent one. If there is none the insertion can be achieved, otherwise the insertion fails. As we always need to loop through all bucket’s elements, the hint doesn’t tell us if the element is already present, and we don’t have any constraint on where the new element is to be inserted, the hint won’t be of any help and will then be ignored.

In the case of `std::unordered_multiset` and `std::unordered_multimap` equivalent elements must be linked together so that the `equal_range(const key_type&)` can return the range of iterators pointing to all equivalent elements. This is where hinting can be used to point to another equivalent element already part of the container and so skip all non equivalent elements of the bucket. So to be useful the hint shall point to an element equivalent to the one being inserted. The new element will be then inserted right after the hint. Note that because of an implementation detail inserting after a node can require updating the bucket of the following node. To check if the next bucket is to be modified we need to compute the following node’s hash code. So if you want your hint to be really efficient it should be followed by another equivalent element, the implementation will detect this equivalence and won’t compute next element hash code.

It is highly advised to start using unordered containers hints only if you have a benchmark that will demonstrate the benefit of it. If you don’t then do not use hints, it might do more harm than good.

9.3.2 Hash Code

9.3.2.1 Hash Code Caching Policy

The unordered containers in libstdc++ may cache the hash code for each element alongside the element itself. In some cases not recalculating the hash code every time it’s needed can improve performance, but the additional memory overhead can also reduce performance, so whether an unordered associative container caches the hash code or not depends on the properties described below.

The C++ standard requires that `erase` and `swap` operations must not throw exceptions. Those operations might need an element’s hash code, but cannot use the hash function if it could throw. This means the hash codes will be cached unless the hash function has a non-throwing exception specification such as `noexcept` or `throw()`.

If the hash function is non-throwing then libstdc++ doesn’t need to cache the hash code for correctness, but might still do so for performance if computing a hash code is an expensive operation, as it may be for arbitrarily long strings. As an extension libstdc++ provides a trait type to describe whether a hash function is fast. By default hash functions are assumed to be fast unless the trait is specialized for the hash function and the trait’s value is false, in which case the hash code will always be cached. The trait can be specialized for user-defined hash functions like so:

```
#include <unordered_set>

struct hasher
{
    std::size_t operator()(int val) const noexcept
    {
        // Some very slow computation of a hash code from an int !
        ...
    }
}
```

```

namespace std
{
    template<>
        struct __is_fast_hash<hasher> : std::false_type
        { };
}

```

9.4 Interacting with C

9.4.1 Containers vs. Arrays

You're writing some code and can't decide whether to use builtin arrays or some kind of container. There are compelling reasons to use one of the container classes, but you're afraid that you'll eventually run into difficulties, change everything back to arrays, and then have to change all the code that uses those data types to keep up with the change.

If your code makes use of the standard algorithms, this isn't as scary as it sounds. The algorithms don't know, nor care, about the kind of "container" on which they work, since the algorithms are only given endpoints to work with. For the container classes, these are iterators (usually `begin()` and `end()`, but not always). For builtin arrays, these are the address of the first element and the **past-the-end** element.

Some very simple wrapper functions can hide all of that from the rest of the code. For example, a pair of functions called `beginof` can be written, one that takes an array, another that takes a vector. The first returns a pointer to the first element, and the second returns the vector's `begin()` iterator.

The functions should be made template functions, and should also be declared inline. As pointed out in the comments in the code below, this can lead to `beginof` being optimized out of existence, so you pay absolutely nothing in terms of increased code size or execution time.

The result is that if all your algorithm calls look like

```
std::transform(beginof(foo), endof(foo), beginof(foo), SomeFunction);
```

then the type of `foo` can change from an array of ints to a vector of ints to a deque of ints and back again, without ever changing any client code.

```

// beginof
template<typename T>
    inline typename vector<T>::iterator
    beginof(vector<T> &v)
    { return v.begin(); }

template<typename T, unsigned int sz>
    inline T*
    beginof(T (&array)[sz]) { return array; }

// endof
template<typename T>
    inline typename vector<T>::iterator
    endof(vector<T> &v)
    { return v.end(); }

template<typename T, unsigned int sz>
    inline T*
    endof(T (&array)[sz]) { return array + sz; }

// lengthof
template<typename T>
    inline typename vector<T>::size_type
    lengthof(vector<T> &v)

```

```
{ return v.size(); }

template<typename T, unsigned int sz>
inline unsigned int
lengthof(T (&)[sz]) { return sz; }
```

Astute readers will notice two things at once: first, that the container class is still a `vector<T>` instead of a more general `Container<T>`. This would mean that three functions for `deque` would have to be added, another three for `list`, and so on. This is due to problems with getting template resolution correct; I find it easier just to give the extra three lines and avoid confusion.

Second, the line

```
inline unsigned int lengthof (T (&)[sz]) { return sz; }
```

looks just weird! Hint: unused parameters can be left nameless.

Chapter 10

Iterators

10.1 Predefined

10.1.1 Iterators vs. Pointers

The following FAQ [entry](#) points out that iterators are not implemented as pointers. They are a generalization of pointers, but they are implemented in libstdc++ as separate classes.

Keeping that simple fact in mind as you design your code will prevent a whole lot of difficult-to-understand bugs.

You can think of it the other way 'round, even. Since iterators are a generalization, that means that *pointers* are *iterators*, and that pointers can be used whenever an iterator would be. All those functions in the Algorithms section of the Standard will work just as well on plain arrays and their pointers.

That doesn't mean that when you pass in a pointer, it gets wrapped into some special delegating iterator-to-pointer class with a layer of overhead. (If you think that's the case anywhere, you don't understand templates to begin with...) Oh, no; if you pass in a pointer, then the compiler will instantiate that template using T^* as a type, and good old high-speed pointer arithmetic as its operations, so the resulting code will be doing exactly the same things as it would be doing if you had hand-coded it yourself (for the 273rd time).

How much overhead *is* there when using an iterator class? Very little. Most of the layering classes contain nothing but typedefs, and typedefs are "meta-information" that simply tell the compiler some nicknames; they don't create code. That information gets passed down through inheritance, so while the compiler has to do work looking up all the names, your runtime code does not. (This has been a prime concern from the beginning.)

10.1.2 One Past the End

This starts off sounding complicated, but is actually very easy, especially towards the end. Trust me.

Beginners usually have a little trouble understand the whole 'past-the-end' thing, until they remember their early algebra classes (see, they *told* you that stuff would come in handy!) and the concept of half-open ranges.

First, some history, and a reminder of some of the funkier rules in C and C++ for builtin arrays. The following rules have always been true for both languages:

1. You can point anywhere in the array, *or to the first element past the end of the array*. A pointer that points to one past the end of the array is guaranteed to be as unique as a pointer to somewhere inside the array, so that you can compare such pointers safely.
2. You can only dereference a pointer that points into an array. If your array pointer points outside the array -- even to just one past the end -- and you dereference it, Bad Things happen.

3. Strictly speaking, simply pointing anywhere else invokes undefined behavior. Most programs won't puke until such a pointer is actually dereferenced, but the standards leave that up to the platform.

The reason this past-the-end addressing was allowed is to make it easy to write a loop to go over an entire array, e.g., while (`*d++ = *s++`);.

So, when you think of two pointers delimiting an array, don't think of them as indexing 0 through $n-1$. Think of them as *boundary markers*:

```

beginning          end
  |                |
  |                |
  |                |
  |                |
  V                V
array of N elements
|---|---|---...---|---|---|
| 0 | 1 |   ...   |N-2|N-1|
|---|---|---...---|---|---|

^                ^
  |                |
  |                |
  |                |
  |                |
beginning          end

```

This is bad. Always having to remember to add or subtract one. Off-by-one bugs very common here.

This is good. This is safe. This is guaranteed to work. Just don't dereference 'end'.

See? Everything between the boundary markers is chapter of the array. Simple.

Now think back to your junior-high school algebra course, when you were learning how to draw graphs. Remember that a graph terminating with a solid dot meant, "Everything up through this point," and a graph terminating with an open dot meant, "Everything up to, but not including, this point," respectively called closed and open ranges? Remember how closed ranges were written with brackets, $[a,b]$, and open ranges were written with parentheses, (a,b) ?

The boundary markers for arrays describe a *half-open range*, starting with (and including) the first element, and ending with (but not including) the last element: $[beginning, end)$. See, I told you it would be simple in the end.

Iterators, and everything working with iterators, follows this same time-honored tradition. A container's `begin()` method returns an iterator referring to the first element, and its `end()` method returns a past-the-end iterator, which is guaranteed to be unique and comparable against any other iterator pointing into the middle of the container.

Container constructors, container methods, and algorithms, all take pairs of iterators describing a range of values on which to operate. All of these ranges are half-open ranges, so you pass the beginning iterator as the starting parameter, and the one-past-the-end iterator as the finishing parameter.

This generalizes very well. You can operate on sub-ranges quite easily this way; functions accepting a $[first, last)$ range don't know or care whether they are the boundaries of an entire {array, sequence, container, whatever}, or whether they only enclose a few elements from the center. This approach also makes zero-length sequences very simple to recognize: if the two endpoints compare equal, then the {array, sequence, container, whatever} is empty.

Just don't dereference `end()`.

Chapter 11

Algorithms

The neatest accomplishment of the algorithms section is that all the work is done via iterators, not containers directly. This means two important things:

1. Anything that behaves like an iterator can be used in one of these algorithms. Raw pointers make great candidates, thus built-in arrays are fine containers, as well as your own iterators.
2. The algorithms do not (and cannot) affect the container as a whole; only the things between the two iterator endpoints. If you pass a range of iterators only enclosing the middle third of a container, then anything outside that range is inviolate.

Even strings can be fed through the algorithms here, although the string class has specialized versions of many of these functions (for example, `string::find()`). Most of the examples on this page will use simple arrays of integers as a playground for algorithms, just to keep things simple. The use of N as a size in the examples is to keep things easy to read but probably won't be valid code. You can use wrappers such as those described in the [containers section](#) to keep real code readable.

The single thing that trips people up the most is the definition of *range* used with iterators; the famous "past-the-end" rule that everybody loves to hate. The [iterators section](#) of this document has a complete explanation of this simple rule that seems to cause so much confusion. Once you get *range* into your head (it's not that hard, honest!), then the algorithms are a cakewalk.

11.1 Mutating

11.1.1 swap

11.1.1.1 Specializations

If you call `std::swap(x, y)`; where x and y are standard containers, then the call will automatically be replaced by a call to `x.swap(y)`; instead.

This allows member functions of each container class to take over, and containers' swap functions should have $O(1)$ complexity according to the standard. (And while "should" allows implementations to behave otherwise and remain compliant, this implementation does in fact use constant-time swaps.) This should not be surprising, since for two containers of the same type to swap contents, only some internal pointers to storage need to be exchanged.

Chapter 12

Numerics

12.1 Complex

12.1.1 complex Processing

Using `complex<>` becomes even more complex-er, sorry, *complicated*, with the not-quite-gratuitously-incompatible addition of complex types to the C language. David Tribble has compiled a list of C++98 and C99 conflict points; his description of C's new type versus those of C++ and how to get them playing together nicely is [here](#).

`complex<>` is intended to be instantiated with a floating-point type. As long as you meet that and some other basic requirements, then the resulting instantiation has all of the usual math operators defined, as well as definitions of `op<<` and `op>>` that work with iostreams: `op<<` prints (u, v) and `op>>` can read u , (u) , and (u, v) .

As an extension to C++11 and for increased compatibility with C, `<complex.h>` includes both `<complex>` and the C99 `<complex.h>` (if the C library provides it).

12.2 Generalized Operations

There are four generalized functions in the `<numeric>` header that follow the same conventions as those in `<algorithm>`. Each of them is overloaded: one signature for common default operations, and a second for fully general operations. Their names are self-explanatory to anyone who works with numerics on a regular basis:

- `accumulate`
- `inner_product`
- `partial_sum`
- `adjacent_difference`

Here is a simple example of the two forms of `accumulate`.

```
int ar[50];
int someval = somefunction();

// ...initialize members of ar to something...

int sum = std::accumulate(ar, ar+50, 0);
int sum_stuff = std::accumulate(ar, ar+50, someval);
int product = std::accumulate(ar, ar+50, 1, std::multiplies<int>());
```

The first call adds all the members of the array, using zero as an initial value for `sum`. The second does the same, but uses `someval` as the starting value (thus, `sum_stuff == sum + someval`). The final call uses the second of the two signatures, and multiplies all the members of the array; here we must obviously use 1 as a starting value instead of 0.

The other three functions have similar dual-signature forms.

12.3 Interacting with C

12.3.1 Numerics vs. Arrays

One of the major reasons why FORTRAN can chew through numbers so well is that it is defined to be free of pointer aliasing, an assumption that C89 is not allowed to make, and neither is C++98. C99 adds a new keyword, `restrict`, to apply to individual pointers. The C++ solution is contained in the library rather than the language (although many vendors can be expected to add this to their compilers as an extension).

That library solution is a set of two classes, five template classes, and "a whole bunch" of functions. The classes are required to be free of pointer aliasing, so compilers can optimize the daylight out of them the same way that they have been for FORTRAN. They are collectively called `valarray`, although strictly speaking this is only one of the five template classes, and they are designed to be familiar to people who have worked with the BLAS libraries before.

12.3.2 C99

In addition to the other topics on this page, we'll note here some of the C99 features that appear in `libstdc++`.

The C99 features depend on the `--enable-c99` configure flag. This flag is already on by default, but it can be disabled by the user. Also, the configuration machinery will disable it if the necessary support for C99 (e.g., header files) cannot be found.

As of GCC 3.0, C99 support includes classification functions such as `isnormal`, `isgreater`, `isnan`, etc. The functions used for 'long long' support such as `strtoll` are supported, as is the `lldiv_t` typedef. Also supported are the wide character functions using 'long long', like `wcstoll`.

Chapter 13

Input and Output

13.1 `iostream` Objects

To minimize the time you have to wait on the compiler, it's good to only include the headers you really need. Many people simply include `<iostream>` when they don't need to -- and that can *penalize your runtime as well*. Here are some tips on which header to use for which situations, starting with the simplest.

`<iosfwd>` should be included whenever you simply need the *name* of an I/O-related class, such as "ofstream" or "basic_streambuf". Like the name implies, these are forward declarations. (A word to all you fellow old school programmers: trying to forward declare classes like "class istream;" won't work. Look in the `<iosfwd>` header if you'd like to know why.) For example,

```
#include <iosfwd>

class MyClass
{
....
std::ifstream&   input_file;
};

extern std::ostream& operator<< (std::ostream&, MyClass&);
```

`<ios>` declares the base classes for the entire I/O stream hierarchy, `std::ios_base` and `std::basic_ios<charT>`, the counting types `std::streamoff` and `std::streamsize`, the file positioning type `std::fpos`, and the various manipulators like `std::hex`, `std::fixed`, `std::noshowbase`, and so forth.

The `ios_base` class is what holds the format flags, the state flags, and the functions which change them (`setf()`, `width()`, `precision()`, etc). You can also store extra data and register callback functions through `ios_base`, but that has been historically underused. Anything which doesn't depend on the type of characters stored is consolidated here.

The class template `basic_ios` is the highest class template in the hierarchy; it is the first one depending on the character type, and holds all general state associated with that type: the pointer to the polymorphic stream buffer, the facet information, etc.

`<streambuf>` declares the class template `basic_streambuf`, and two standard instantiations, `streambuf` and `wstreambuf`. If you need to work with the vastly useful and capable stream buffer classes, e.g., to create a new form of storage transport, this header is the one to include.

`<istream>` and `<ostream>` are the headers to include when you are using the overloaded `>>` and `<<` operators, or any of the other abstract stream formatting functions. For example,

```
#include <istream>

std::ostream& operator<< (std::ostream& os, MyClass& c)
{
    return os << c.data1() << c.data2();
}
```

The `std::istream` and `std::ostream` classes are the abstract parents of the various concrete implementations. If you are only using the interfaces, then you only need to use the appropriate interface header.

`<iomanip>` provides "extractors and inserters that alter information maintained by class `ios_base` and its derived classes," such as `std::setprecision` and `std::setw`. If you need to write expressions like `os << setw(3);` or `is >> setbase(8);`, you must include `<iomanip>`.

`<sstream>` and `<fstream>` declare the six stringstream and fstream classes. As they are the standard concrete descendants of `istream` and `ostream`, you will already know about them.

Finally, `<iostream>` provides the eight standard global objects (`cin`, `cout`, etc). To do this correctly, this header also provides the contents of the `<istream>` and `<ostream>` headers, but nothing else. The contents of this header look like:

```
#include <ostream>
#include <istream>

namespace std
{
extern istream cin;
extern ostream cout;
....

// this is explained below
static ios_base::Init __foo;    // not its real name
}
```

Now, the runtime penalty mentioned previously: the global objects must be initialized before any of your own code uses them; this is guaranteed by the standard. Like any other global object, they must be initialized once and only once. This is typically done with a construct like the one above, and the nested class `ios_base::Init` is specified in the standard for just this reason.

How does it work? Because the header is included before any of your code, the `__foo` object is constructed before any of your objects. (Global objects are built in the order in which they are declared, and destroyed in reverse order.) The first time the constructor runs, the eight stream objects are set up.

The `static` keyword means that each object file compiled from a source file containing `<iostream>` will have its own private copy of `__foo`. There is no specified order of construction across object files (it's one of those pesky NP complete problems that make life so interesting), so one copy in each object file means that the stream objects are guaranteed to be set up before any of your code which uses them could run, thereby meeting the requirements of the standard.

The penalty, of course, is that after the first copy of `__foo` is constructed, all the others are just wasted processor time. The time spent is merely for an increment-and-test inside a function call, but over several dozen or hundreds of object files, that time can add up. (It's not in a tight loop, either.)

The lesson? Only include `<iostream>` when you need to use one of the standard objects in that source file; you'll pay less startup time. Only include the header files you need to in general; your compile times will go down when there's less parsing work to do.

13.2 Stream Buffers

13.2.1 Derived streambuf Classes

Creating your own stream buffers for I/O can be remarkably easy. If you are interested in doing so, we highly recommend two very excellent books: [Standard C++ IOStreams and Locales](#) by Langer and Kreft, ISBN 0-201-18395-1, and [The C++ Standard Library](#) by Nicolai Josuttis, ISBN 0-201-37926-0. Both are published by Addison-Wesley, who isn't paying us a cent for saying that, honest.

Here is a simple example, `io/outbuf1`, from the Josuttis text. It transforms everything sent through it to uppercase. This version assumes many things about the nature of the character type being used (for more information, read the books or the newsgroups):

```
#include <iostream>
#include <streambuf>
```

```

#include <locale>
#include <cstdio>

class outbuf : public std::streambuf
{
protected:
/* central output function
 * - print characters in uppercase mode
 */
virtual int_type overflow (int_type c) {
    if (c != EOF) {
        // convert lowercase to uppercase
        c = std::toupper(static_cast<char>(c), getloc());

        // and write the character to the standard output
        if (putchar(c) == EOF) {
            return EOF;
        }
        return c;
    }
};

int main()
{
// create special output buffer
outbuf ob;
// initialize output stream with that output buffer
std::ostream out(&ob);

out << "31 hexadecimal: "
    << std::hex << 31 << std::endl;
return 0;
}

```

Try it yourself! More examples can be found in 3.1.x code, in `include/ext/*_filebuf.h`, and in this article by James Kanze: [Filtering Streambufs](#).

13.2.2 Buffering

First, are you sure that you understand buffering? Particularly the fact that C++ may not, in fact, have anything to do with it?

The rules for buffering can be a little odd, but they aren't any different from those of C. (Maybe that's why they can be a bit odd.) Many people think that writing a newline to an output stream automatically flushes the output buffer. This is true only when the output stream is, in fact, a terminal and not a file or some other device -- and *that* may not even be true since C++ says nothing about files nor terminals. All of that is system-dependent. (The "newline-buffer-flushing only occurring on terminals" thing is mostly true on Unix systems, though.)

Some people also believe that sending `endl` down an output stream only writes a newline. This is incorrect; after a newline is written, the buffer is also flushed. Perhaps this is the effect you want when writing to a screen -- get the text out as soon as possible, etc -- but the buffering is largely wasted when doing this to a file:

```

output << "a line of text" << endl;
output << some_data_variable << endl;
output << "another line of text" << endl;

```

The proper thing to do in this case to just write the data out and let the libraries and the system worry about the buffering. If you need a newline, just write a newline:

```

output << "a line of text\n"
    << some_data_variable << '\n'

```

```
<< "another line of text\n";
```

I have also joined the output statements into a single statement. You could make the code prettier by moving the single newline to the start of the quoted text on the last line, for example.

If you do need to flush the buffer above, you can send an `endl` if you also need a newline, or just flush the buffer yourself:

```
output << ..... << flush;    // can use std::flush manipulator
output.flush();              // or call a member fn
```

On the other hand, there are times when writing to a file should be like writing to standard error; no buffering should be done because the data needs to appear quickly (a prime example is a log file for security-related information). The way to do this is just to turn off the buffering *before any I/O operations at all* have been done (note that opening counts as an I/O operation):

```
std::ofstream  os;
std::ifstream  is;
int  i;

os.rdbuf()->pubsetbuf(0,0);
is.rdbuf()->pubsetbuf(0,0);

os.open("/foo/bar/baz");
is.open("/qux/quux/quuux");
...
os << "this data is written immediately\n";
is >> i;    // and this will probably cause a disk read
```

Since all aspects of buffering are handled by a `streambuf`-derived member, it is necessary to get at that member with `rdbuf()`. Then the public version of `setbuf` can be called. The arguments are the same as those for the Standard C I/O Library function (a buffer area followed by its size).

A great deal of this is implementation-dependent. For example, `streambuf` does not specify any actions for its own `setbuf()`-ish functions; the classes derived from `streambuf` each define behavior that "makes sense" for that class: an argument of (0,0) turns off buffering for `filebuf` but does nothing at all for its siblings `stringbuf` and `strstreambuf`, and specifying anything other than (0,0) has varying effects. User-defined classes derived from `streambuf` can do whatever they want. (For `filebuf` and arguments for (p, s) other than zeros, `libstdc++` does what you'd expect: the first s bytes of p are used as a buffer, which you must allocate and deallocate.)

A last reminder: there are usually more buffers involved than just those at the language/library level. Kernel buffers, disk buffers, and the like will also have an effect. Inspecting and changing those are system-dependent.

13.3 Memory Based Streams

13.3.1 Compatibility With `strstream`

Stringstreams (defined in the header `<sstream>`) are in this author's opinion one of the coolest things since sliced time. An example of their use is in the Received Wisdom section for Sect1 21 (Strings), [describing how to format strings](#).

The quick definition is: they are siblings of `ifstream` and `ofstream`, and they do for `std::string` what their siblings do for files. All that work you put into writing `<<` and `>>` functions for your classes now pays off *again!* Need to format a string before passing the string to a function? Send your stuff via `<<` to an `ostrstream`. You've read a string as input and need to parse it? Initialize an `istrstream` with that string, and then pull pieces out of it with `>>`. Have a `stringstream` and need to get a copy of the string inside? Just call the `str()` member function.

This only works if you've written your `<</>>` functions correctly, though, and correctly means that they take `istream` and `ostream` as parameters, not `ifstream` and `ofstream`. If they take the latter, then your I/O operators will work fine with file streams, but with nothing else -- including `stringstreams`.

If you are a user of the `strstream` classes, you need to update your code. You don't have to explicitly append `ends` to terminate the C-style character array, you don't have to mess with "freezing" functions, and you don't have to manage the memory yourself. The `strstreams` have been officially deprecated, which means that 1) future revisions of the C++ Standard won't support them, and 2) if you use them, people will laugh at you.

13.4 File Based Streams

13.4.1 Copying a File

So you want to copy a file quickly and easily, and most important, completely portably. And since this is C++, you have an open ifstream (call it IN) and an open ofstream (call it OUT):

```
#include <fstream>

std::ifstream IN ("input_file");
std::ofstream OUT ("output_file");
```

Here's the easiest way to get it completely wrong:

```
OUT << IN;
```

For those of you who don't already know why this doesn't work (probably from having done it before), I invite you to quickly create a simple text file called "input_file" containing the sentence

```
The quick brown fox jumped over the lazy dog.
```

surrounded by blank lines. Code it up and try it. The contents of "output_file" may surprise you.

Seriously, go do it. Get surprised, then come back. It's worth it.

The thing to remember is that the `basic_[io]stream` classes handle formatting, nothing else. In particular, they break up on whitespace. The actual reading, writing, and storing of data is handled by the `basic_streambuf` family. Fortunately, the `operator<<` is overloaded to take an ostream and a pointer-to-streambuf, in order to help with just this kind of "dump the data verbatim" situation.

Why a *pointer* to streambuf and not just a streambuf? Well, the [io]streams hold pointers (or references, depending on the implementation) to their buffers, not the actual buffers. This allows polymorphic behavior on the chapter of the buffers as well as the streams themselves. The pointer is easily retrieved using the `rdbuf()` member function. Therefore, the easiest way to copy the file is:

```
OUT << IN.rdbuf();
```

So what *was* happening with `OUT<<IN`? Undefined behavior, since that particular `<<` isn't defined by the Standard. I have seen instances where it is implemented, but the character extraction process removes all the whitespace, leaving you with no blank lines and only "Thequickbrownfox...". With libraries that do not define that operator, IN (or one of IN's member pointers) sometimes gets converted to a `void*`, and the output file then contains a perfect text representation of a hexadecimal address (quite a big surprise). Others don't compile at all.

Also note that none of this is specific to `o*/f*`streams. The operators shown above are all defined in the parent `basic_ostream` class and are therefore available with all possible descendants.

13.4.2 Binary Input and Output

The first and most important thing to remember about binary I/O is that opening a file with `ios::binary` is not, repeat *not*, the only thing you have to do. It is not a silver bullet, and will not allow you to use the `<</>>` operators of the normal fstreams to do binary I/O.

Sorry. Them's the breaks.

This isn't going to try and be a complete tutorial on reading and writing binary files (because "binary" covers a lot of ground), but we will try and clear up a couple of misconceptions and common errors.

First, `ios::binary` has exactly one defined effect, no more and no less. Normal text mode has to be concerned with the newline characters, and the runtime system will translate between (for example) `'\n'` and the appropriate end-of-line sequence (LF on Unix, CRLF on DOS, CR on Macintosh, etc). (There are other things that normal mode does, but that's the most obvious.)

Opening a file in binary mode disables this conversion, so reading a CRLF sequence under Windows won't accidentally get mapped to a '\n' character, etc. Binary mode is not supposed to suddenly give you a bitstream, and if it is doing so in your program then you've discovered a bug in your vendor's compiler (or some other chapter of the C++ implementation, possibly the runtime system).

Second, using `<<` to write and `>>` to read isn't going to work with the standard file stream classes, even if you use `skipws` during reading. Why not? Because `ifstream` and `ofstream` exist for the purpose of *formatting*, not reading and writing. Their job is to interpret the data into text characters, and that's exactly what you don't want to happen during binary I/O.

Third, using the `get()` and `put()/write()` member functions still aren't guaranteed to help you. These are "unformatted" I/O functions, but still character-based. (This may or may not be what you want, see below.)

Notice how all the problems here are due to the inappropriate use of *formatting* functions and classes to perform something which *requires* that formatting not be done? There are a seemingly infinite number of solutions, and a few are listed here:

- "Derive your own `fstream`-type classes and write your own `<</>>` operators to do binary I/O on whatever data types you're using."

This is a Bad Thing, because while the compiler would probably be just fine with it, other humans are going to be confused. The overloaded bitshift operators have a well-defined meaning (formatting), and this breaks it.

- "Build the file structure in memory, then `mmap()` the file and copy the structure. "

Well, this is easy to make work, and easy to break, and is pretty equivalent to using `::read()` and `::write()` directly, and makes no use of the `iostream` library at all...

- "Use `streambufs`, that's what they're there for."

While not trivial for the beginner, this is the best of all solutions. The `streambuf/filebuf` layer is the layer that is responsible for actual I/O. If you want to use the C++ library for binary I/O, this is where you start.

How to go about using `streambufs` is a bit beyond the scope of this document (at least for now), but while `streambufs` go a long way, they still leave a couple of things up to you, the programmer. As an example, byte ordering is completely between you and the operating system, and you have to handle it yourself.

Deriving a `streambuf` or `filebuf` class from the standard ones, one that is specific to your data types (or an abstraction thereof) is probably a good idea, and lots of examples exist in journals and on Usenet. Using the standard `filebufs` directly (either by declaring your own or by using the pointer returned from an `fstream`'s `rdbuf()`) is certainly feasible as well.

One area that causes problems is trying to do bit-by-bit operations with `filebufs`. C++ is no different from C in this respect: I/O must be done at the byte level. If you're trying to read or write a few bits at a time, you're going about it the wrong way. You must read/write an integral number of bytes and then process the bytes. (For example, the `streambuf` functions take and return variables of type `int_type`.)

Another area of problems is opening text files in binary mode. Generally, binary mode is intended for binary files, and opening text files in binary mode means that you now have to deal with all of those end-of-line and end-of-file problems that we mentioned before.

An instructive thread from `comp.lang.c++.moderated` delved off into this topic starting more or less at [this](#) post and continuing to the end of the thread. (The subject heading is "binary iostreams" on both `comp.std.c++` and `comp.lang.c++.moderated`.) Take special note of the replies by James Kanze and Dietmar Kühl.

Briefly, the problems of byte ordering and type sizes mean that the unformatted functions like `ostream::put()` and `istream::get()` cannot safely be used to communicate between arbitrary programs, or across a network, or from one invocation of a program to another invocation of the same program on a different platform, etc.

13.5 Interacting with C

13.5.1 Using FILE* and file descriptors

See the [extensions](#) for using `FILE` and file descriptors with `ofstream` and `ifstream`.

13.5.2 Performance

Pathetic Performance? Ditch C.

It sounds like a flame on C, but it isn't. Really. Calm down. I'm just saying it to get your attention.

Because the C++ library includes the C library, both C-style and C++-style I/O have to work at the same time. For example:

```
#include <iostream>
#include <cstdio>

std::cout << "Hel";
std::printf ("lo, worl");
std::cout << "d!\n";
```

This must do what you think it does.

Alert members of the audience will immediately notice that buffering is going to make a hash of the output unless special steps are taken.

The special steps taken by `libstdc++`, at least for version 3.0, involve doing very little buffering for the standard streams, leaving most of the buffering to the underlying C library. (This kind of thing is tricky to get right.) The upside is that correctness is ensured. The downside is that writing through `cout` can quite easily lead to awful performance when the C++ I/O library is layered on top of the C I/O library (as it is for 3.0 by default). Some patches have been applied which improve the situation for 3.1.

However, the C and C++ standard streams only need to be kept in sync when both libraries' facilities are in use. If your program only uses C++ I/O, then there's no need to sync with the C streams. The right thing to do in this case is to call

```
#include any of the I/O headers such as ios, iostream, etc

std::ios::sync_with_stdio(false);
```

You must do this before performing any I/O via the C++ stream objects. Once you call this, the C++ streams will operate independently of the (unused) C streams. For GCC 3.x, this means that `cout` and company will become fully buffered on their own.

Note, by the way, that the synchronization requirement only applies to the standard streams (`cin`, `cout`, `cerr`, `clog`, and their wide-character counterparts). File stream objects that you declare yourself have no such requirement and are fully buffered.

Chapter 14

Atomics

Facilities for atomic operations.

14.1 API Reference

All items are declared in the standard header file `atomic`.

Set of typedefs that map `int` to `atomic_int`, and so on for all builtin integral types. Global enumeration `memory_order` to control memory ordering. Also includes `atomic`, a class template with member functions such as `load` and `store` that is instantiable such that `atomic_int` is the base class of `atomic<int>`.

Full API details.

Chapter 15

Concurrency

Facilities for concurrent operation, and control thereof.

15.1 API Reference

All items are declared in one of four standard header files.

In header `mutex`, class template `mutex` and variants, class `once_flag`, and class template `unique_lock`.

In header `condition_variable`, classes `condition_variable` and `condition_variable_any`.

In header `thread`, class `thread` and namespace `this_thread`.

In header `future`, class template `future` and class template `shared_future`, class template `promise`, and `packaged_task`.

Full API details.

Part III

Extensions

Here we will make an attempt at describing the non-Standard extensions to the library. Some of these are from older versions of standard library components, namely SGI's STL, and some of these are GNU's.

Before you leap in and use any of these extensions, be aware of two things:

1. Non-Standard means exactly that.

The behavior, and the very existence, of these extensions may change with little or no warning. (Ideally, the really good ones will appear in the next revision of C++.) Also, other platforms, other compilers, other versions of g++ or libstdc++ may not recognize these names, or treat them differently, or...

2. You should know how to access these headers properly.
-

Chapter 16

Compile Time Checks

Also known as concept checking.

In 1999, SGI added *concept checkers* to their implementation of the STL: code which checked the template parameters of instantiated pieces of the STL, in order to insure that the parameters being used met the requirements of the standard. For example, the Standard requires that types passed as template parameters to `vector` be “Assignable” (which means what you think it means). The checking was done during compilation, and none of the code was executed at runtime.

Unfortunately, the size of the compiler files grew significantly as a result. The checking code itself was cumbersome. And bugs were found in it on more than one occasion.

The primary author of the checking code, Jeremy Siek, had already started work on a replacement implementation. The new code has been formally reviewed and accepted into [the Boost libraries](#), and we are pleased to incorporate it into the GNU C++ library.

The new version imposes a much smaller space overhead on the generated object file. The checks are also cleaner and easier to read and understand.

They are off by default for all versions of GCC from 3.0 to 3.4 (the latest release at the time of writing). They can be enabled at configure time with `--enable-concept-checks`. You can enable them on a per-translation-unit basis with `#define _GLIBCXX_CONCEPT_CHECKS` for GCC 3.4 and higher (or with `#define _GLIBCPP_CONCEPT_CHECKS` for versions 3.1, 3.2 and 3.3).

Please note that the concept checks only validate the requirements of the old C++03 standard. C++11 was expected to have first-class support for template parameter constraints based on concepts in the core language. This would have obviated the need for the library-simulated concept checking described above, but was not part of C++11.

Chapter 17

Debug Mode

17.1 Intro

By default, `libstdc++` is built with efficiency in mind, and therefore performs little or no error checking that is not required by the C++ standard. This means that programs that incorrectly use the C++ standard library will exhibit behavior that is not portable and may not even be predictable, because they tread into implementation-specific or undefined behavior. To detect some of these errors before they can become problematic, `libstdc++` offers a debug mode that provides additional checking of library facilities, and will report errors in the use of `libstdc++` as soon as they can be detected by emitting a description of the problem to standard error and aborting the program. This debug mode is available with GCC 3.4.0 and later versions.

The `libstdc++` debug mode performs checking for many areas of the C++ standard, but the focus is on checking interactions among standard iterators, containers, and algorithms, including:

- *Safe iterators:* Iterators keep track of the container whose elements they reference, so errors such as incrementing a past-the-end iterator or dereferencing an iterator that points to a container that has been destructed are diagnosed immediately.
- *Algorithm preconditions:* Algorithms attempt to validate their input parameters to detect errors as early as possible. For instance, the `set_intersection` algorithm requires that its iterator parameters `first1` and `last1` form a valid iterator range, and that the sequence `[first1, last1)` is sorted according to the same predicate that was passed to `set_intersection`; the `libstdc++` debug mode will detect an error if the sequence is not sorted or was sorted by a different predicate.

17.2 Semantics

A program that uses the C++ standard library correctly will maintain the same semantics under debug mode as it had with the normal (release) library. All functional and exception-handling guarantees made by the normal library also hold for the debug mode library, with one exception: performance guarantees made by the normal library may not hold in the debug mode library. For instance, erasing an element in a `std::list` is a constant-time operation in normal library, but in debug mode it is linear in the number of iterators that reference that particular list. So while your (correct) program won't change its results, it is likely to execute more slowly.

`libstdc++` includes many extensions to the C++ standard library. In some cases the extensions are obvious, such as the hashed associative containers, whereas other extensions give predictable results to behavior that would otherwise be undefined, such as throwing an exception when a `std::basic_string` is constructed from a NULL character pointer. This latter category also includes implementation-defined and unspecified semantics, such as the growth rate of a vector. Use of these extensions is not considered incorrect, so code that relies on them will not be rejected by debug mode. However, use of these extensions may affect the portability of code to other implementations of the C++ standard library, and is therefore somewhat hazardous. For this reason, the `libstdc++` debug mode offers a "pedantic" mode (similar to GCC's `-pedantic` compiler flag) that attempts to emulate the semantics guaranteed by the C++ standard. For instance, constructing a `std::basic_string` with a NULL character pointer would result in an exception under normal mode or non-pedantic debug mode (this is a `libstdc++` extension), whereas under pedantic debug mode `libstdc++` would signal an error. To enable the pedantic debug mode, compile your program

with both `-D_GLIBCXX_DEBUG` and `-D_GLIBCXX_DEBUG_PEDANTIC`. (N.B. In GCC 3.4.x and 4.0.0, due to a bug, `-D_GLIBCXX_DEBUG_PEDANTIC` was also needed. The problem has been fixed in GCC 4.0.1 and later versions.)

The following library components provide extra debugging capabilities in debug mode:

- `std::basic_string` (no safe iterators and see note below)
- `std::bitset`
- `std::deque`
- `std::list`
- `std::map`
- `std::multimap`
- `std::multiset`
- `std::set`
- `std::vector`
- `std::unordered_map`
- `std::unordered_multimap`
- `std::unordered_set`
- `std::unordered_multiset`

N.B. although there are precondition checks for some string operations, e.g. `operator[]`, they will not always be run when using the `char` and `wchar_t` specialisations (`std::string` and `std::wstring`). This is because `libstdc++` uses GCC's `extern template` extension to provide explicit instantiations of `std::string` and `std::wstring`, and those explicit instantiations don't include the debug-mode checks. If the containing functions are inlined then the checks will run, so compiling with `-O1` might be enough to enable them. Alternatively `-D_GLIBCXX_EXTERN_TEMPLATE=0` will suppress the declarations of the explicit instantiations and cause the functions to be instantiated with the debug-mode checks included, but this is unsupported and not guaranteed to work. For full debug-mode support you can use the `__gnu_debug::basic_string` debugging container directly, which always works correctly.

17.3 Using

17.3.1 Using the Debug Mode

To use the `libstdc++` debug mode, compile your application with the compiler flag `-D_GLIBCXX_DEBUG`. Note that this flag changes the sizes and behavior of standard class templates such as `std::vector`, and therefore you can only link code compiled with debug mode and code compiled without debug mode if no instantiation of a container is passed between the two translation units.

By default, error messages are formatted to fit on lines of about 78 characters. The environment variable `GLIBCXX_DEBUG_MESSAGE_LENGTH` can be used to request a different length.

17.3.2 Using a Specific Debug Container

When it is not feasible to recompile your entire application, or only specific containers need checking, debugging containers are available as GNU extensions. These debugging containers are functionally equivalent to the standard drop-in containers used in debug mode, but they are available in a separate namespace as GNU extensions and may be used in programs compiled with either release mode or with debug mode. The following table provides the names and headers of the debugging containers:

In addition, when compiling in C++11 mode, these additional containers have additional debug capability.

Container	Header	Debug container	Debug header
<code>std::bitset</code>	<code>bitset</code>	<code>__gnu_debug::bitset</code>	<code><debug/bitset></code>
<code>std::deque</code>	<code>deque</code>	<code>__gnu_debug::deque</code>	<code><debug/deque></code>
<code>std::list</code>	<code>list</code>	<code>__gnu_debug::list</code>	<code><debug/list></code>
<code>std::map</code>	<code>map</code>	<code>__gnu_debug::map</code>	<code><debug/map></code>
<code>std::multimap</code>	<code>map</code>	<code>__gnu_debug::multimap</code>	<code><debug/map></code>
<code>std::multiset</code>	<code>set</code>	<code>__gnu_debug::multiset</code>	<code><debug/set></code>
<code>std::set</code>	<code>set</code>	<code>__gnu_debug::set</code>	<code><debug/set></code>
<code>std::string</code>	<code>string</code>	<code>__gnu_debug::string</code>	<code><debug/string></code>
<code>std::wstring</code>	<code>string</code>	<code>__gnu_debug::wstring</code>	<code><debug/string></code>
<code>std::basic_string</code>	<code>string</code>	<code>__gnu_debug::basic_string</code>	<code><debug/string></code>
<code>std::vector</code>	<code>vector</code>	<code>__gnu_debug::vector</code>	<code><debug/vector></code>

Table 17.1: Debugging Containers

Container	Header	Debug container	Debug header
<code>std::unordered_map</code>	<code>unordered_map</code>	<code>__gnu_debug::unordered_map</code>	<code><debug/unordered_map></code>
<code>std::unordered_multimap</code>	<code>unordered_map</code>	<code>__gnu_debug::unordered_multimap</code>	<code><debug/unordered_map></code>
<code>std::unordered_set</code>	<code>unordered_set</code>	<code>__gnu_debug::unordered_set</code>	<code><debug/unordered_set></code>
<code>std::unordered_multiset</code>	<code>unordered_set</code>	<code>__gnu_debug::unordered_multiset</code>	<code><debug/unordered_set></code>

Table 17.2: Debugging Containers C++11

17.4 Design

17.4.1 Goals

The libstdc++ debug mode replaces unsafe (but efficient) standard containers and iterators with semantically equivalent safe standard containers and iterators to aid in debugging user programs. The following goals directed the design of the libstdc++ debug mode:

- *Correctness*: the libstdc++ debug mode must not change the semantics of the standard library for all cases specified in the ANSI/ISO C++ standard. The essence of this constraint is that any valid C++ program should behave in the same manner regardless of whether it is compiled with debug mode or release mode. In particular, entities that are defined in namespace `std` in release mode should remain defined in namespace `std` in debug mode, so that legal specializations of namespace `std` entities will remain valid. A program that is not valid C++ (e.g., invokes undefined behavior) is not required to behave similarly, although the debug mode will abort with a diagnostic when it detects undefined behavior.
- *Performance*: the additional of the libstdc++ debug mode must not affect the performance of the library when it is compiled in release mode. Performance of the libstdc++ debug mode is secondary (and, in fact, will be worse than the release mode).
- *Usability*: the libstdc++ debug mode should be easy to use. It should be easily incorporated into the user's development environment (e.g., by requiring only a single new compiler switch) and should produce reasonable diagnostics when it detects a problem with the user program. Usability also involves detection of errors when using the debug mode incorrectly, e.g., by linking a release-compiled object against a debug-compiled object if in fact the resulting program will not run correctly.
- *Minimize recompilation*: While it is expected that users recompile at least part of their program to use debug mode, the amount of recompilation affects the detect-compile-debug turnaround time. This indirectly affects the usefulness of the debug mode, because debugging some applications may require rebuilding a large amount of code, which may not be feasible when the suspect code may be very localized. There are several levels of conformance to this requirement, each with its own usability and implementation characteristics. In general, the higher-numbered conformance levels are more usable (i.e., require less recompilation) but are more complicated to implement than the lower-numbered conformance levels.
 1. *Full recompilation*: The user must recompile his or her entire application and all C++ libraries it depends on, including the C++ standard library that ships with the compiler. This must be done even if only a small part of the program can use debugging features.
 2. *Full user recompilation*: The user must recompile his or her entire application and all C++ libraries it depends on, but not the C++ standard library itself. This must be done even if only a small part of the program can use debugging features. This can be achieved given a full recompilation system by compiling two versions of the standard library when the compiler is installed and linking against the appropriate one, e.g., a multilibs approach.
 3. *Partial recompilation*: The user must recompile the parts of his or her application and the C++ libraries it depends on that will use the debugging facilities directly. This means that any code that uses the debuggable standard containers would need to be recompiled, but code that does not use them (but may, for instance, use `IOStreams`) would not have to be recompiled.
 4. *Per-use recompilation*: The user must recompile the parts of his or her application and the C++ libraries it depends on where debugging should occur, and any other code that interacts with those containers. This means that a set of translation units that accesses a particular standard container instance may either be compiled in release mode (no checking) or debug mode (full checking), but must all be compiled in the same way; a translation unit that does not see that standard container instance need not be recompiled. This also means that a translation unit *A* that contains a particular instantiation (say, `std::vector<int>`) compiled in release mode can be linked against a translation unit *B* that contains the same instantiation compiled in debug mode (a feature not present with partial recompilation). While this behavior is technically a violation of the One Definition Rule, this ability tends to be very important in practice. The libstdc++ debug mode supports this level of recompilation.
 5. *Per-unit recompilation*: The user must only recompile the translation units where checking should occur, regardless of where debuggable standard containers are used. This has also been dubbed "`-g` mode", because the `-g` compiler switch works in this way, emitting debugging information at a per-translation-unit granularity. We believe that this level of recompilation is in fact not possible if we intend to supply safe iterators, leave the program semantics unchanged, and not regress in performance under release mode because we cannot associate extra information with an iterator (to form a safe iterator) without either reserving that space in release mode (performance regression) or allocating extra memory associated with each iterator with `new` (changes the program semantics).

17.4.2 Methods

This section provides an overall view of the design of the libstdc++ debug mode and details the relationship between design decisions and the stated design goals.

17.4.2.1 The Wrapper Model

The libstdc++ debug mode uses a wrapper model where the debugging versions of library components (e.g., iterators and containers) form a layer on top of the release versions of the library components. The debugging components first verify that the operation is correct (aborting with a diagnostic if an error is found) and will then forward to the underlying release-mode container that will perform the actual work. This design decision ensures that we cannot regress release-mode performance (because the release-mode containers are left untouched) and partially enables **mixing debug and release code** at link time, although that will not be discussed at this time.

Two types of wrappers are used in the implementation of the debug mode: container wrappers and iterator wrappers. The two types of wrappers interact to maintain relationships between iterators and their associated containers, which are necessary to detect certain types of standard library usage errors such as dereferencing past-the-end iterators or inserting into a container using an iterator from a different container.

17.4.2.1.1 Safe Iterators

Iterator wrappers provide a debugging layer over any iterator that is attached to a particular container, and will manage the information detailing the iterator's state (singular, dereferenceable, etc.) and tracking the container to which the iterator is attached. Because iterators have a well-defined, common interface the iterator wrapper is implemented with the iterator adaptor class template `__gnu_debug::_Safe_iterator`, which takes two template parameters:

- `Iterator`: The underlying iterator type, which must be either the `iterator` or `const_iterator` typedef from the sequence type this iterator can reference.
- `Sequence`: The type of sequence that this iterator references. This sequence must be a safe sequence (discussed below) whose `iterator` or `const_iterator` typedef is the type of the safe iterator.

17.4.2.1.2 Safe Sequences (Containers)

Container wrappers provide a debugging layer over a particular container type. Because containers vary greatly in the member functions they support and the semantics of those member functions (especially in the area of iterator invalidation), container wrappers are tailored to the container they reference, e.g., the debugging version of `std::list` duplicates the entire interface of `std::list`, adding additional semantic checks and then forwarding operations to the real `std::list` (a public base class of the debugging version) as appropriate. However, all safe containers inherit from the class template `__gnu_debug::_Safe_sequence`, instantiated with the type of the safe container itself (an instance of the curiously recurring template pattern).

The iterators of a container wrapper will be **safe iterators** that reference sequences of this type and wrap the iterators provided by the release-mode base class. The debugging container will use only the safe iterators within its own interface (therefore requiring the user to use safe iterators, although this does not change correct user code) and will communicate with the release-mode base class with only the underlying, unsafe, release-mode iterators that the base class exports.

The debugging version of `std::list` will have the following basic structure:

```
template<typename _Tp, typename _Allocator = allocator<_Tp>
class debug-list :
    public release-list<_Tp, _Allocator>,
    public __gnu_debug::_Safe_sequence<debug-list<_Tp, _Allocator> >
{
    typedef release-list<_Tp, _Allocator> _Base;
    typedef debug-list<_Tp, _Allocator> _Self;

public:
```

```

typedef __gnu_debug::_Safe_iterator<typename _Base::iterator, _Self>      iterator;
typedef __gnu_debug::_Safe_iterator<typename _Base::const_iterator, _Self> ←
    const_iterator;

// duplicate std::list interface with debugging semantics
};

```

17.4.2.2 Precondition Checking

The debug mode operates primarily by checking the preconditions of all standard library operations that it supports. Preconditions that are always checked (regardless of whether or not we are in debug mode) are checked via the `__check_xxx` macros defined and documented in the source file `include/debug/debug.h`. Preconditions that may or may not be checked, depending on the debug-mode macro `_GLIBCXX_DEBUG`, are checked via the `__requires_xxx` macros defined and documented in the same source file. Preconditions are validated using any additional information available at run-time, e.g., the containers that are associated with a particular iterator, the position of the iterator within those containers, the distance between two iterators that may form a valid range, etc. In the absence of suitable information, e.g., an input iterator that is not a safe iterator, these precondition checks will silently succeed.

The majority of precondition checks use the aforementioned macros, which have the secondary benefit of having prewritten debug messages that use information about the current status of the objects involved (e.g., whether an iterator is singular or what sequence it is attached to) along with some static information (e.g., the names of the function parameters corresponding to the objects involved). When not using these macros, the debug mode uses either the debug-mode assertion macro `_GLIBCXX_DEBUG_ASSERT`, its pedantic cousin `_GLIBCXX_DEBUG_PEDASSERT`, or the assertion check macro that supports more advance formulation of error messages, `_GLIBCXX_DEBUG_VERIFY`. These macros are documented more thoroughly in the debug mode source code.

17.4.2.3 Release- and debug-mode coexistence

The `libstdc++` debug mode is the first debug mode we know of that is able to provide the "Per-use recompilation" (4) guarantee, that allows release-compiled and debug-compiled code to be linked and executed together without causing unpredictable behavior. This guarantee minimizes the recompilation that users are required to perform, shortening the detect-compile-debug bug hunting cycle and making the debug mode easier to incorporate into development environments by minimizing dependencies.

Achieving link- and run-time coexistence is not a trivial implementation task. To achieve this goal we required a small extension to the GNU C++ compiler (since incorporated into the C++11 language specification, described in the GCC Manual for the C++ language as [namespace association](#)), and a complex organization of debug- and release-modes. The end result is that we have achieved per-use recompilation but have had to give up some checking of the `std::basic_string` class template (namely, safe iterators).

17.4.2.3.1 Compile-time coexistence of release- and debug-mode components

Both the release-mode components and the debug-mode components need to exist within a single translation unit so that the debug versions can wrap the release versions. However, only one of these components should be user-visible at any particular time with the standard name, e.g., `std::list`.

In release mode, we define only the release-mode version of the component with its standard name and do not include the debugging component at all. The release mode version is defined within the namespace `std`. Minus the namespace associations, this method leaves the behavior of release mode completely unchanged from its behavior prior to the introduction of the `libstdc++` debug mode. Here's an example of what this ends up looking like, in C++.

```

namespace std
{
    template<typename _Tp, typename _Alloc = allocator<_Tp> >
        class list
        {
            // ...
        };
} // namespace std

```

In debug mode we include the release-mode container (which is now defined in the namespace `__cxx1998`) and also the debug-mode container. The debug-mode container is defined within the namespace `__debug`, which is associated with namespace `std` via the C++11 namespace association language feature. This method allows the debug and release versions of the same component to coexist at compile-time and link-time without causing an unreasonable maintenance burden, while minimizing confusion. Again, this boils down to C++ code as follows:

```
namespace std
{
  namespace __cxx1998
  {
    template<typename _Tp, typename _Alloc = allocator<_Tp> >
      class list
      {
      // ...
      };
  } // namespace __gnu_norm

  namespace __debug
  {
    template<typename _Tp, typename _Alloc = allocator<_Tp> >
      class list
      : public __cxx1998::list<_Tp, _Alloc>,
      public __gnu_debug::_Safe_sequence<list<_Tp, _Alloc> >
      {
      // ...
      };
  } // namespace __cxx1998

  // namespace __debug __attribute__ ((strong));
  inline namespace __debug { }
}
```

17.4.2.3.2 Link- and run-time coexistence of release- and debug-mode components

Because each component has a distinct and separate release and debug implementation, there is no issue with link-time coexistence: the separate namespaces result in different mangled names, and thus unique linkage.

However, components that are defined and used within the C++ standard library itself face additional constraints. For instance, some of the member functions of `std::moneypunct` return `std::basic_string`. Normally, this is not a problem, but with a mixed mode standard library that could be using either debug-mode or release-mode `basic_string` objects, things get more complicated. As the return value of a function is not encoded into the mangled name, there is no way to specify a release-mode or a debug-mode string. In practice, this results in runtime errors. A simplified example of this problem is as follows.

Take this translation unit, compiled in debug-mode:

```
// -D_GLIBCXX_DEBUG
#include <string>

std::string test02();

std::string test01()
{
  return test02();
}

int main()
{
  test01();
  return 0;
}
```

... and linked to this translation unit, compiled in release mode:

```
#include <string>

std::string
test02()
{
    return std::string("toast");
}
```

For this reason we cannot easily provide safe iterators for the `std::basic_string` class template, as it is present throughout the C++ standard library. For instance, locale facets define typedefs that include `basic_string`: in a mixed debug/release program, should that typedef be based on the debug-mode `basic_string` or the release-mode `basic_string`? While the answer could be "both", and the difference hidden via renaming a la the debug/release containers, we must note two things about locale facets:

1. They exist as shared state: one can create a facet in one translation unit and access the facet via the same type name in a different translation unit. This means that we cannot have two different versions of locale facets, because the types would not be the same across debug/release-mode translation unit barriers.
2. They have virtual functions returning strings: these functions mangle in the same way regardless of the mangling of their return types (see above), and their precise signatures can be relied upon by users because they may be overridden in derived classes.

With the design of `libstdc++` debug mode, we cannot effectively hide the differences between debug and release-mode strings from the user. Failure to hide the differences may result in unpredictable behavior, and for this reason we have opted to only perform `basic_string` changes that do not require ABI changes. The effect on users is expected to be minimal, as there are simple alternatives (e.g., `__gnu_debug::basic_string`), and the usability benefit we gain from the ability to mix debug- and release-compiled translation units is enormous.

17.4.2.3 Alternatives for Coexistence

The coexistence scheme above was chosen over many alternatives, including language-only solutions and solutions that also required extensions to the C++ front end. The following is a partial list of solutions, with justifications for our rejection of each.

- *Completely separate debug/release libraries:* This is by far the simplest implementation option, where we do not allow any coexistence of debug- and release-compiled translation units in a program. This solution has an extreme negative affect on usability, because it is quite likely that some libraries an application depends on cannot be recompiled easily. This would not meet our *usability* or *minimize recompilation* criteria well.
- *Add a Debug boolean template parameter:* Partial specialization could be used to select the debug implementation when `Debug == true`, and the state of `_GLIBCXX_DEBUG` could decide whether the default `Debug` argument is `true` or `false`. This option would break conformance with the C++ standard in both debug *and* release modes. This would not meet our *correctness* criteria.
- *Packaging a debug flag in the allocators:* We could reuse the `Allocator` template parameter of containers by adding a sentinel wrapper `debug<>` that signals the user's intention to use debugging, and pick up the `debug<>` allocator wrapper in a partial specialization. However, this has two drawbacks: first, there is a conformance issue because the default allocator would not be the standard-specified `std::allocator<T>`. Secondly (and more importantly), users that specify allocators instead of implicitly using the default allocator would not get debugging containers. Thus this solution fails the *correctness* criteria.
- *Define debug containers in another namespace, and employ a using declaration (or directive):* This is an enticing option, because it would eliminate the need for the `link_name` extension by aliasing the templates. However, there is no true template aliasing mechanism in C++, because both `using` directives and `using` declarations disallow specialization. This method fails the *correctness* criteria.
- *Use implementation-specific properties of anonymous namespaces.* See [this post](#) This method fails the *correctness* criteria.

- *Extension: allow reopening on namespaces*: This would allow the debug mode to effectively alias the namespace `std` to an internal namespace, such as `__gnu_std_debug`, so that it is completely separate from the release-mode `std` namespace. While this will solve some renaming problems and ensure that debug- and release-compiled code cannot be mixed unsafely, it ensures that debug- and release-compiled code cannot be mixed at all. For instance, the program would have two `std::cout` objects! This solution would fail the *minimize recompilation* requirement, because we would only be able to support option (1) or (2).
- *Extension: use link name*: This option involves complicated re-naming between debug-mode and release-mode components at compile time, and then a g++ extension called *link name* to recover the original names at link time. There are two drawbacks to this approach. One, it's very verbose, relying on macro renaming at compile time and several levels of include ordering. Two, ODR issues remained with container member functions taking no arguments in mixed-mode settings resulting in equivalent link names, `vector::push_back()` being one example. See [link name](#)

Other options may exist for implementing the debug mode, many of which have probably been considered and others that may still be lurking. This list may be expanded over time to include other options that we could have implemented, but in all cases the full ramifications of the approach (as measured against the design goals for a libstdc++ debug mode) should be considered first. The DejaGNU testsuite includes some testcases that check for known problems with some solutions (e.g., the `using` declaration solution that breaks user specialization), and additional testcases will be added as we are able to identify other typical problem cases. These test cases will serve as a benchmark by which we can compare debug mode implementations.

17.4.3 Other Implementations

There are several existing implementations of debug modes for C++ standard library implementations, although none of them directly supports debugging for programs using libstdc++. The existing implementations include:

- **SafeSTL**: SafeSTL was the original debugging version of the Standard Template Library (STL), implemented by Cay S. Horstmann on top of the Hewlett-Packard STL. Though it inspired much work in this area, it has not been kept up-to-date for use with modern compilers or C++ standard library implementations.
- **STLport**: STLport is a free implementation of the C++ standard library derived from the [SGI implementation](#), and ported to many other platforms. It includes a debug mode that uses a wrapper model (that in some ways inspired the libstdc++ debug mode design), although at the time of this writing the debug mode is somewhat incomplete and meets only the "Full user recompilation" (2) recompilation guarantee by requiring the user to link against a different library in debug mode vs. release mode.
- **Metrowerks CodeWarrior**: The C++ standard library that ships with Metrowerks CodeWarrior includes a debug mode. It is a full debug-mode implementation (including debugging for CodeWarrior extensions) and is easy to use, although it meets only the "Full recompilation" (1) recompilation guarantee.

Chapter 18

Parallel Mode

The `libstdc++` parallel mode is an experimental parallel implementation of many algorithms the C++ Standard Library.

Several of the standard algorithms, for instance `std::sort`, are made parallel using OpenMP annotations. These parallel mode constructs and can be invoked by explicit source declaration or by compiling existing sources with a specific compiler flag.

18.1 Intro

The following library components in the include `numeric` are included in the parallel mode:

- `std::accumulate`
- `std::adjacent_difference`
- `std::inner_product`
- `std::partial_sum`

The following library components in the include `algorithm` are included in the parallel mode:

- `std::adjacent_find`
 - `std::count`
 - `std::count_if`
 - `std::equal`
 - `std::find`
 - `std::find_if`
 - `std::find_first_of`
 - `std::for_each`
 - `std::generate`
 - `std::generate_n`
 - `std::lexicographical_compare`
 - `std::mismatch`
 - `std::search`
-

- `std::search_n`
- `std::transform`
- `std::replace`
- `std::replace_if`
- `std::max_element`
- `std::merge`
- `std::min_element`
- `std::nth_element`
- `std::partial_sort`
- `std::partition`
- `std::random_shuffle`
- `std::set_union`
- `std::set_intersection`
- `std::set_symmetric_difference`
- `std::set_difference`
- `std::sort`
- `std::stable_sort`
- `std::unique_copy`

18.2 Semantics

The parallel mode STL algorithms are currently not exception-safe, i.e. user-defined functors must not throw exceptions. Also, the order of execution is not guaranteed for some functions, of course. Therefore, user-defined functors should not have any concurrent side effects.

Since the current GCC OpenMP implementation does not support OpenMP parallel regions in concurrent threads, it is not possible to call parallel STL algorithm in concurrent threads, either. It might work with other compilers, though.

18.3 Using

18.3.1 Prerequisite Compiler Flags

Any use of parallel functionality requires additional compiler and runtime support, in particular support for OpenMP. Adding this support is not difficult: just compile your application with the compiler flag `-fopenmp`. This will link in `libgomp`, the OpenMP [GNU implementation](#), whose presence is mandatory.

In addition, hardware that supports atomic operations and a compiler capable of producing atomic operations is mandatory: GCC defaults to no support for atomic operations on some common hardware architectures. Activating atomic operations may require explicit compiler flags on some targets (like sparc and x86), such as `-march=i686`, `-march=native` or `-mcpu=v9`. See the GCC manual for more information.

18.3.2 Using Parallel Mode

To use the libstdc++ parallel mode, compile your application with the prerequisite flags as detailed above, and in addition add `-D_GLIBCXX_PARALLEL`. This will convert all use of the standard (sequential) algorithms to the appropriate parallel equivalents. Please note that this doesn't necessarily mean that everything will end up being executed in a parallel manner, but rather that the heuristics and settings coded into the parallel versions will be used to determine if all, some, or no algorithms will be executed using parallel variants.

Note that the `_GLIBCXX_PARALLEL` define may change the sizes and behavior of standard class templates such as `std::search`, and therefore one can only link code compiled with parallel mode and code compiled without parallel mode if no instantiation of a container is passed between the two translation units. Parallel mode functionality has distinct linkage, and cannot be confused with normal mode symbols.

18.3.3 Using Specific Parallel Components

When it is not feasible to recompile your entire application, or only specific algorithms need to be parallel-aware, individual parallel algorithms can be made available explicitly. These parallel algorithms are functionally equivalent to the standard drop-in algorithms used in parallel mode, but they are available in a separate namespace as GNU extensions and may be used in programs compiled with either release mode or with parallel mode.

An example of using a parallel version of `std::sort`, but no other parallel algorithms, is:

```
#include <vector>
#include <parallel/algorithm>

int main()
{
    std::vector<int> v(100);

    // ...

    // Explicitly force a call to parallel sort.
    __gnu_parallel::sort(v.begin(), v.end());
    return 0;
}
```

Then compile this code with the prerequisite compiler flags (`-fopenmp` and any necessary architecture-specific flags for atomic operations.)

The following table provides the names and headers of all the parallel algorithms that can be used in a similar manner:

18.4 Design

18.4.1 Interface Basics

All parallel algorithms are intended to have signatures that are equivalent to the ISO C++ algorithms replaced. For instance, the `std::adjacent_find` function is declared as:

```
namespace std
{
    template<typename _FIter>
        _FIter
        adjacent_find(_FIter, _FIter);
}
```

Which means that there should be something equivalent for the parallel version. Indeed, this is the case:

Algorithm	Header	Parallel algorithm	Parallel header
<code>std::accumulate</code>	numeric	<code>__gnu_parallel::accumulate</code>	parallel/numeric
<code>std::adjacent_difference</code>	numeric	<code>__gnu_parallel::adjacent_difference</code>	parallel/numeric
<code>std::inner_product</code>	numeric	<code>__gnu_parallel::inner_product</code>	parallel/numeric
<code>std::partial_sum</code>	numeric	<code>__gnu_parallel::partial_sum</code>	parallel/numeric
<code>std::adjacent_find</code>	algorithm	<code>__gnu_parallel::adjacent_find</code>	parallel/algorithm
<code>std::count</code>	algorithm	<code>__gnu_parallel::count</code>	parallel/algorithm
<code>std::count_if</code>	algorithm	<code>__gnu_parallel::count_if</code>	parallel/algorithm
<code>std::equal</code>	algorithm	<code>__gnu_parallel::equal</code>	parallel/algorithm
<code>std::find</code>	algorithm	<code>__gnu_parallel::find</code>	parallel/algorithm
<code>std::find_if</code>	algorithm	<code>__gnu_parallel::find_if</code>	parallel/algorithm
<code>std::find_first_of</code>	algorithm	<code>__gnu_parallel::find_first_of</code>	parallel/algorithm
<code>std::for_each</code>	algorithm	<code>__gnu_parallel::for_each</code>	parallel/algorithm
<code>std::generate</code>	algorithm	<code>__gnu_parallel::generate</code>	parallel/algorithm
<code>std::generate_n</code>	algorithm	<code>__gnu_parallel::generate_n</code>	parallel/algorithm
<code>std::lexicographical_compare</code>	algorithm	<code>__gnu_parallel::lexicographical_compare</code>	parallel/algorithm
<code>std::mismatch</code>	algorithm	<code>__gnu_parallel::mismatch</code>	parallel/algorithm
<code>std::search</code>	algorithm	<code>__gnu_parallel::search</code>	parallel/algorithm
<code>std::search_n</code>	algorithm	<code>__gnu_parallel::search_n</code>	parallel/algorithm
<code>std::transform</code>	algorithm	<code>__gnu_parallel::transform</code>	parallel/algorithm
<code>std::replace</code>	algorithm	<code>__gnu_parallel::replace</code>	parallel/algorithm
<code>std::replace_if</code>	algorithm	<code>__gnu_parallel::replace_if</code>	parallel/algorithm
<code>std::max_element</code>	algorithm	<code>__gnu_parallel::max_element</code>	parallel/algorithm
<code>std::merge</code>	algorithm	<code>__gnu_parallel::merge</code>	parallel/algorithm
<code>std::min_element</code>	algorithm	<code>__gnu_parallel::min_element</code>	parallel/algorithm
<code>std::nth_element</code>	algorithm	<code>__gnu_parallel::nth_element</code>	parallel/algorithm
<code>std::partial_sort</code>	algorithm	<code>__gnu_parallel::partial_sort</code>	parallel/algorithm
<code>std::partition</code>	algorithm	<code>__gnu_parallel::partition</code>	parallel/algorithm
<code>std::random_shuffle</code>	algorithm	<code>__gnu_parallel::random_shuffle</code>	parallel/algorithm
<code>std::set_union</code>	algorithm	<code>__gnu_parallel::set_union</code>	parallel/algorithm
<code>std::set_intersection</code>	algorithm	<code>__gnu_parallel::set_intersection</code>	parallel/algorithm
		<code>__gnu_parallel::</code>	

```

namespace std
{
  namespace __parallel
  {
    template<typename _FIter>
      _FIter
      adjacent_find(_FIter, _FIter);

    ...
  }
}

```

But... why the ellipses?

The ellipses in the example above represent additional overloads required for the parallel version of the function. These additional overloads are used to dispatch calls from the ISO C++ function signature to the appropriate parallel function (or sequential function, if no parallel functions are deemed worthy), based on either compile-time or run-time conditions.

The available signature options are specific for the different algorithms/algorithm classes.

The general view of overloads for the parallel algorithms look like this:

- ISO C++ signature
- ISO C++ signature + `sequential_tag` argument
- ISO C++ signature + algorithm-specific tag type (several signatures)

Please note that the implementation may use additional functions (designated with the `_switch` suffix) to dispatch from the ISO C++ signature to the correct parallel version. Also, some of the algorithms do not have support for run-time conditions, so the last overload is therefore missing.

18.4.2 Configuration and Tuning

18.4.2.1 Setting up the OpenMP Environment

Several aspects of the overall runtime environment can be manipulated by standard OpenMP function calls.

To specify the number of threads to be used for the algorithms globally, use the function `omp_set_num_threads`. An example:

```

#include <stdlib.h>
#include <omp.h>

int main()
{
  // Explicitly set number of threads.
  const int threads_wanted = 20;
  omp_set_dynamic(false);
  omp_set_num_threads(threads_wanted);

  // Call parallel mode algorithms.

  return 0;
}

```

Some algorithms allow the number of threads being set for a particular call, by augmenting the algorithm variant. See the next section for further information.

Other parts of the runtime environment able to be manipulated include nested parallelism (`omp_set_nested`), schedule kind (`omp_set_schedule`), and others. See the OpenMP documentation for more information.

18.4.2.2 Compile Time Switches

To force an algorithm to execute sequentially, even though parallelism is switched on in general via the macro `_GLIBCXX_PARALLEL`, add `__gnu_parallel::sequential_tag()` to the end of the algorithm's argument list.

Like so:

```
std::sort(v.begin(), v.end(), __gnu_parallel::sequential_tag());
```

Some parallel algorithm variants can be excluded from compilation by preprocessor defines. See the doxygen documentation on `completetime_settings.h` and `features.h` for details.

For some algorithms, the desired variant can be chosen at compile-time by appending a tag object. The available options are specific to the particular algorithm (class).

For the "embarrassingly parallel" algorithms, there is only one "tag object type", the enum `_Parallelism`. It takes one of the following values, `__gnu_parallel::parallel_tag`, `__gnu_parallel::balanced_tag`, `__gnu_parallel::unbalanced_tag`, `__gnu_parallel::omp_loop_tag`, `__gnu_parallel::omp_loop_static_tag`. This means that the actual parallelization strategy is chosen at run-time. (Choosing the variants at compile-time will come soon.)

For the following algorithms in general, we have `__gnu_parallel::parallel_tag` and `__gnu_parallel::default_parallel_tag`, in addition to `__gnu_parallel::sequential_tag`. `__gnu_parallel::default_parallel_tag` chooses the default algorithm at compiletime, as does omitting the tag. `__gnu_parallel::parallel_tag` postpones the decision to runtime (see next section). For all tags, the number of threads desired for this call can optionally be passed to the respective tag's constructor.

The `multiway_merge` algorithm comes with the additional choices, `__gnu_parallel::exact_tag` and `__gnu_parallel::sampling_tag`. Exact and sampling are the two available splitting strategies.

For the `sort` and `stable_sort` algorithms, there are several additional choices, namely `__gnu_parallel::multiway_mergesort_tag`, `__gnu_parallel::multiway_mergesort_exact_tag`, `__gnu_parallel::multiway_mergesort_sampling_tag`, `__gnu_parallel::quicksort_tag`, and `__gnu_parallel::balanced_quicksort_tag`. Multiway mergesort comes with the two splitting strategies for multi-way merging. The quicksort options cannot be used for `stable_sort`.

18.4.2.3 Run Time Settings and Defaults

The default parallelization strategy, the choice of specific algorithm strategy, the minimum threshold limits for individual parallel algorithms, and aspects of the underlying hardware can be specified as desired via manipulation of `__gnu_parallel::_Settings` member data.

First off, the choice of parallelization strategy: serial, parallel, or heuristically deduced. This corresponds to `__gnu_parallel::_Settings::algorithm_strategy` and is a value of enum `__gnu_parallel::AlgorithmStrategy` type. Choices include: `heuristic`, `force_serial`, and `force_parallel`. The default is `heuristic`.

Next, the sub-choices for algorithm variant, if not fixed at compile-time. Specific algorithms like `find` or `sort` can be implemented in multiple ways: when this is the case, a `__gnu_parallel::_Settings` member exists to pick the default strategy. For example, `__gnu_parallel::_Settings::sort_algorithm` can have any values of enum `__gnu_parallel::SortAlgorithm`: `MWMS`, `QS`, or `QS_BALANCED`.

Likewise for setting the minimal threshold for algorithm parallelization. Parallelism always incurs some overhead. Thus, it is not helpful to parallelize operations on very small sets of data. Because of this, measures are taken to avoid parallelizing below a certain, pre-determined threshold. For each algorithm, a minimum problem size is encoded as a variable in the active `__gnu_parallel::_Settings` object. This threshold variable follows the following naming scheme: `__gnu_parallel::_Settings::[algorithm]_minimal_n`. So, for `fill`, the threshold variable is `__gnu_parallel::_Settings::fill_minimal_n`,

Finally, hardware details like L1/L2 cache size can be hardwired via `__gnu_parallel::_Settings::L1_cache_size` and friends.

All these configuration variables can be changed by the user, if desired. There exists one global instance of the class `_Settings`, i. e. it is a singleton. It can be read and written by calling `__gnu_parallel::_Settings::get` and `__gnu_parallel::set`.

`lel::_Settings::set`, respectively. Please note that the first call return a const object, so direct manipulation is forbidden. See [settings.h](#) for complete details.

A small example of tuning the default:

```
#include <parallel/algorithm>
#include <parallel/settings.h>

int main()
{
    __gnu_parallel::_Settings s;
    s.algorithm_strategy = __gnu_parallel::force_parallel;
    __gnu_parallel::_Settings::set(s);

    // Do work... all algorithms will be parallelized, always.

    return 0;
}
```

18.4.3 Implementation Namespaces

One namespace contain versions of code that are always explicitly sequential: `__gnu_serial`.

Two namespaces contain the parallel mode: `std::__parallel` and `__gnu_parallel`.

Parallel implementations of standard components, including template helpers to select parallelism, are defined in namespace `std::__parallel`. For instance, `std::transform` from `algorithm` has a parallel counterpart in `std::__parallel::transform` from `parallel/algorithm`. In addition, these parallel implementations are injected into namespace `__gnu_parallel` with using declarations.

Support and general infrastructure is in namespace `__gnu_parallel`.

More information, and an organized index of types and functions related to the parallel mode on a per-namespace basis, can be found in the generated source documentation.

18.5 Testing

Both the normal conformance and regression tests and the supplemental performance tests work.

To run the conformance and regression tests with the parallel mode active,

```
make check-parallel
```

The log and summary files for conformance testing are in the `testsuite/parallel` directory.

To run the performance tests with the parallel mode active,

```
make check-performance-parallel
```

The result file for performance testing are in the `testsuite` directory, in the file `libstdc++_performance.sum`. In addition, the policy-based containers have their own visualizations, which have additional software dependencies than the usual bare-boned text file, and can be generated by using the `make doc-performance` rule in the `testsuite`'s Makefile.

18.6 Bibliography

- [52] Johannes SinglerLeonor Frias, Copyright © 2007 , Workshop on Highly Parallel Processing on a Chip (HPPC) 2007. (LNCS) .
- [53] Johannes SinglerPeter SandersFelix Putze, Copyright © 2007 , Euro-Par 2007: Parallel Processing. (LNCS 4641) .

Chapter 19

Profile Mode

19.1 Intro

Goal: Give performance improvement advice based on recognition of suboptimal usage patterns of the standard library.

Method: Wrap the standard library code. Insert calls to an instrumentation library to record the internal state of various components at interesting entry/exit points to/from the standard library. Process trace, recognize suboptimal patterns, give advice. For details, see [paper presented at CGO 2009](#).

Strengths:

- Unintrusive solution. The application code does not require any modification.
- The advice is call context sensitive, thus capable of identifying precisely interesting dynamic performance behavior.
- The overhead model is pay-per-view. When you turn off a diagnostic class at compile time, its overhead disappears.

Drawbacks:

- You must recompile the application code with custom options.
- You must run the application on representative input. The advice is input dependent.
- The execution time will increase, in some cases by factors.

19.1.1 Using the Profile Mode

This is the anticipated common workflow for program `foo.cc`:

```
$ cat foo.cc
#include <vector>
int main() {
    vector<int> v;
    for (int k = 0; k < 1024; ++k) v.insert(v.begin(), k);
}

$ g++ -D_GLIBCXX_PROFILE foo.cc
$ ./a.out
$ cat libstdcxx-profile.txt
vector-to-list: improvement = 5: call stack = 0x804842c ...
    : advice = change std::vector to std::list
vector-size: improvement = 3: call stack = 0x804842c ...
    : advice = change initial container size from 0 to 1024
```

Anatomy of a warning:

- **Warning id.** This is a short descriptive string for the class that this warning belongs to. E.g., "vector-to-list".
- **Estimated improvement.** This is an approximation of the benefit expected from implementing the change suggested by the warning. It is given on a log10 scale. Negative values mean that the alternative would actually do worse than the current choice. In the example above, 5 comes from the fact that the overhead of inserting at the beginning of a vector vs. a list is around $1024 * 1024 / 2$, which is around $10e5$. The improvement from setting the initial size to 1024 is in the range of $10e3$, since the overhead of dynamic resizing is linear in this case.
- **Call stack.** Currently, the addresses are printed without symbol name or code location attribution. Users are expected to postprocess the output using, for instance, `addr2line`.
- **The warning message.** For some warnings, this is static text, e.g., "change vector to list". For other warnings, such as the one above, the message contains numeric advice, e.g., the suggested initial size of the vector.

Three files are generated. `libstdcxx-profile.txt` contains human readable advice. `libstdcxx-profile.raw` contains implementation specific data about each diagnostic. Their format is not documented. They are sufficient to generate all the advice given in `libstdcxx-profile.txt`. The advantage of keeping this raw format is that traces from multiple executions can be aggregated simply by concatenating the raw traces. We intend to offer an external utility program that can issue advice from a trace. `libstdcxx-profile.conf.out` lists the actual diagnostic parameters used. To alter parameters, edit this file and rename it to `libstdcxx-profile.conf`.

Advice is given regardless whether the transformation is valid. For instance, we advise changing a map to an `unordered_map` even if the application semantics require that data be ordered. We believe such warnings can help users understand the performance behavior of their application better, which can lead to changes at a higher abstraction level.

19.1.2 Tuning the Profile Mode

Compile time switches and environment variables (see also file `profiler.h`). Unless specified otherwise, they can be set at compile time using `-D<name>` or by setting variable `<name>` in the environment where the program is run, before starting execution.

- `_GLIBCXX_PROFILE_NO_<diagnostic>`: disable specific diagnostics. See section Diagnostics for possible values. (Environment variables not supported.)
- `_GLIBCXX_PROFILE_TRACE_PATH_ROOT`: set an alternative root path for the output files.
- `_GLIBCXX_PROFILE_MAX_WARN_COUNT`: set it to the maximum number of warnings desired. The default value is 10.
- `_GLIBCXX_PROFILE_MAX_STACK_DEPTH`: if set to 0, the advice will be collected and reported for the program as a whole, and not for each call context. This could also be used in continuous regression tests, where you just need to know whether there is a regression or not. The default value is 32.
- `_GLIBCXX_PROFILE_MEM_PER_DIAGNOSTIC`: set a limit on how much memory to use for the accounting tables for each diagnostic type. When this limit is reached, new events are ignored until the memory usage decreases under the limit. Generally, this means that newly created containers will not be instrumented until some live containers are deleted. The default is 128 MB.
- `_GLIBCXX_PROFILE_NO_THREADS`: Make the library not use threads. If thread local storage (TLS) is not available, you will get a preprocessor error asking you to set `-D_GLIBCXX_PROFILE_NO_THREADS` if your program is single-threaded. Multithreaded execution without TLS is not supported. (Environment variable not supported.)
- `_GLIBCXX_HAVE_EXECINFO_H`: This name should be defined automatically at library configuration time. If your library was configured without `execinfo.h`, but you have it in your include path, you can define it explicitly. Without it, advice is collected for the program as a whole, and not for each call context. (Environment variable not supported.)

Code Location	Use
<code>libstdc++-v3/include/std/*</code>	Preprocessor code to redirect to profile extension headers.
<code>libstdc++-v3/include/profile/*</code>	Profile extension public headers (map, vector, ...).
<code>libstdc++-v3/include/profile/impl/*</code>	Profile extension internals. Implementation files are only included from <code>impl/profiler.h</code> , which is the only file included from the public headers.

Table 19.1: Profile Code Location

19.2 Design

19.2.1 Wrapper Model

In order to get our instrumented library version included instead of the release one, we use the same wrapper model as the debug mode. We subclass entities from the release version. Wherever `_GLIBCXX_PROFILE` is defined, the release namespace is `std::__norm`, whereas the profile namespace is `std::__profile`. Using plain `std` translates into `std::__profile`.

Whenever possible, we try to wrap at the public interface level, e.g., in `unordered_set` rather than in `hashtable`, in order not to depend on implementation.

Mixing object files built with and without the profile mode must not affect the program execution. However, there are no guarantees to the accuracy of diagnostics when using even a single object not built with `-D_GLIBCXX_PROFILE`. Currently, mixing the profile mode with debug and parallel extensions is not allowed. Mixing them at compile time will result in preprocessor errors. Mixing them at link time is undefined.

19.2.2 Instrumentation

Instead of instrumenting every public entry and exit point, we chose to add instrumentation on demand, as needed by individual diagnostics. The main reason is that some diagnostics require us to extract bits of internal state that are particular only to that diagnostic. We plan to formalize this later, after we learn more about the requirements of several diagnostics.

All the instrumentation points can be switched on and off using `-D[_NO]_GLIBCXX_PROFILE_<diagnostic>` options. With all the instrumentation calls off, there should be negligible overhead over the release version. This property is needed to support diagnostics based on timing of internal operations. For such diagnostics, we anticipate turning most of the instrumentation off in order to prevent profiling overhead from polluting time measurements, and thus diagnostics.

All the instrumentation on/off compile time switches live in `include/profile/profiler.h`.

19.2.3 Run Time Behavior

For practical reasons, the instrumentation library processes the trace partially rather than dumping it to disk in raw form. Each event is processed when it occurs. It is usually attached a cost and it is aggregated into the database of a specific diagnostic class. The cost model is based largely on the standard performance guarantees, but in some cases we use knowledge about GCC's standard library implementation.

Information is indexed by (1) call stack and (2) instance id or address to be able to understand and summarize precise creation-use-destruction dynamic chains. Although the analysis is sensitive to dynamic instances, the reports are only sensitive to call context. Whenever a dynamic instance is destroyed, we accumulate its effect to the corresponding entry for the call stack of its constructor location.

For details, see [paper presented at CGO 2009](#).

19.2.4 Analysis and Diagnostics

Final analysis takes place offline, and it is based entirely on the generated trace and debugging info in the application binary. See section Diagnostics for a list of analysis types that we plan to support.

The input to the analysis is a table indexed by profile type and call stack. The data type for each entry depends on the profile type.

19.2.5 Cost Model

While it is likely that cost models become complex as we get into more sophisticated analysis, we will try to follow a simple set of rules at the beginning.

- *Relative benefit estimation:* The idea is to estimate or measure the cost of all operations in the original scenario versus the scenario we advise to switch to. For instance, when advising to change a vector to a list, an occurrence of the `insert` method will generally count as a benefit. Its magnitude depends on (1) the number of elements that get shifted and (2) whether it triggers a reallocation.
- *Synthetic measurements:* We will measure the relative difference between similar operations on different containers. We plan to write a battery of small tests that compare the times of the executions of similar methods on different containers. The idea is to run these tests on the target machine. If this training phase is very quick, we may decide to perform it at library initialization time. The results can be cached on disk and reused across runs.
- *Timers:* We plan to use timers for operations of larger granularity, such as `sort`. For instance, we can switch between different sort methods on the fly and report the one that performs best for each call context.
- *Show stoppers:* We may decide that the presence of an operation nullifies the advice. For instance, when considering switching from `set` to `unordered_set`, if we detect use of operator `++`, we will simply not issue the advice, since this could signal that the use case require a sorted container.

19.2.6 Reports

There are two types of reports. First, if we recognize a pattern for which we have a substitute that is likely to give better performance, we print the advice and estimated performance gain. The advice is usually associated to a code position and possibly a call stack.

Second, we report performance characteristics for which we do not have a clear solution for improvement. For instance, we can point to the user the top 10 `multimap` locations which have the worst data locality in actual traversals. Although this does not offer a solution, it helps the user focus on the key problems and ignore the uninteresting ones.

19.2.7 Testing

First, we want to make sure we preserve the behavior of the release mode. You can just type `"make check-profile"`, which builds and runs the whole test suite in profile mode.

Second, we want to test the correctness of each diagnostic. We created a `profile` directory in the test suite. Each diagnostic must come with at least two tests, one for false positives and one for false negatives.

19.3 Extensions for Custom Containers

Many large projects use their own data structures instead of the ones in the standard library. If these data structures are similar in functionality to the standard library, they can be instrumented with the same hooks that are used to instrument the standard library. The instrumentation API is exposed in file `profiler.h` (look for "Instrumentation hooks").

19.4 Empirical Cost Model

Currently, the cost model uses formulas with predefined relative weights for alternative containers or container implementations. For instance, iterating through a vector is X times faster than iterating through a list.

(Under development.) We are working on customizing this to a particular machine by providing an automated way to compute the actual relative weights for operations on the given machine.

(Under development.) We plan to provide a performance parameter database format that can be filled in either by hand or by an automated training mechanism. The analysis module will then use this database instead of the built in. generic parameters.

19.5 Implementation Issues

19.5.1 Stack Traces

Accurate stack traces are needed during profiling since we group events by call context and dynamic instance. Without accurate traces, diagnostics may be hard to interpret. For instance, when giving advice to the user it is imperative to reference application code, not library code.

Currently we are using the libc `backtrace` routine to get stack traces. `_GLIBCXX_PROFILE_STACK_DEPTH` can be set to 0 if you are willing to give up call context information, or to a small positive value to reduce run time overhead.

19.5.2 Symbolization of Instruction Addresses

The profiling and analysis phases use only instruction addresses. An external utility such as `addr2line` is needed to postprocess the result. We do not plan to add symbolization support in the profile extension. This would require access to symbol tables, debug information tables, external programs or libraries and other system dependent information.

19.5.3 Concurrency

Our current model is simplistic, but precise. We cannot afford to approximate because some of our diagnostics require precise matching of operations to container instance and call context. During profiling, we keep a single information table per diagnostic. There is a single lock per information table.

19.5.4 Using the Standard Library in the Instrumentation Implementation

As much as we would like to avoid uses of `libstdc++` within our instrumentation library, containers such as `unordered_map` are very appealing. We plan to use them as long as they are named properly to avoid ambiguity.

19.5.5 Malloc Hooks

User applications/libraries can provide malloc hooks. When the implementation of the malloc hooks uses `stdlibc++`, there can be an infinite cycle between the profile mode instrumentation and the malloc hook code.

We protect against reentrance to the profile mode instrumentation code, which should avoid this problem in most cases. The protection mechanism is thread safe and exception safe. This mechanism does not prevent reentrance to the malloc hook itself, which could still result in deadlock, if, for instance, the malloc hook uses non-recursive locks. XXX: A definitive solution to this problem would be for the profile extension to use a custom allocator internally, and perhaps not to use `libstdc++`.

19.5.6 Construction and Destruction of Global Objects

The profiling library state is initialized at the first call to a profiling method. This allows us to record the construction of all global objects. However, we cannot do the same at destruction time. The trace is written by a function registered by `atexit`, thus invoked by `exit`.

19.6 Developer Information

19.6.1 Big Picture

The profile mode headers are included with `-D_GLIBCXX_PROFILE` through preprocessor directives in `include/std/*`. Instrumented implementations are provided in `include/profile/*`. All instrumentation hooks are macros defined in `include/profile/profiler.h`.

All the implementation of the instrumentation hooks is in `include/profile/impl/*`. Although all the code gets included, thus is publicly visible, only a small number of functions are called from outside this directory. All calls to hook implementations must be done through macros defined in `profiler.h`. The macro must ensure (1) that the call is guarded against reentrance and (2) that the call can be turned off at compile time using a `-D_GLIBCXX_PROFILE_... compiler option`.

19.6.2 How To Add A Diagnostic

Let's say the diagnostic name is "magic".

If you need to instrument a header not already under `include/profile/*`, first edit the corresponding header under `include/std/` and add a preprocessor directive such as the one in `include/std/vector`:

```
#ifndef _GLIBCXX_PROFILE
# include <profile/vector>
#endif
```

If the file you need to instrument is not yet under `include/profile/`, make a copy of the one in `include/debug`, or the main implementation. You'll need to include the main implementation and inherit the classes you want to instrument. Then define the methods you want to instrument, define the instrumentation hooks and add calls to them. Look at `include/profile/vector` for an example.

Add macros for the instrumentation hooks in `include/profile/impl/profiler.h`. Hook names must start with `__prof_cxx_`. Make sure they transform in no code with `-D_NO_GLIBCXX_PROFILE_MAGIC`. Make sure all calls to any method in namespace `__gnu_profile` is protected against reentrance using macro `_GLIBCXX_PROFILE_REENTRANCE_GUARD`. All names of methods in namespace `__gnu_profile` called from `profiler.h` must start with `__trace_magic_`.

Add the implementation of the diagnostic.

- Create new file `include/profile/impl/profiler_magic.h`.
- Define class `__magic_info:public __object_info_base`. This is the representation of a line in the object table. The `__merge` method is used to aggregate information across all dynamic instances created at the same call context. The `__magnitude` must return the estimation of the benefit as a number of small operations, e.g., number of words copied. The `__write` method is used to produce the raw trace. The `__advice` method is used to produce the advice string.
- Define class `__magic_stack_info:public __magic_info`. This defines the content of a line in the stack table.
- Define class `__trace_magic:public __trace_base<__magic_info, __magic_stack_info>`. It defines the content of the trace associated with this diagnostic.

Add initialization and reporting calls in `include/profile/impl/profiler_trace.h`. Use `__trace_vector_to_list` as an example.

Add documentation in file `doc/xml/manual/profile_mode.xml`.

19.7 Diagnostics

The table below presents all the diagnostics we intend to implement. Each diagnostic has a corresponding compile time switch `-D_GLIBCXX_PROFILE_<diagnostic>`. Groups of related diagnostics can be turned on with a single switch. For instance, `-D_GLIBCXX_PROFILE_LOCALITY` is equivalent to `-D_GLIBCXX_PROFILE_SOFTWARE_PREFETCH -D_GLIBCXX_PROFILE_RBTREE_LOCALITY`.

The benefit, cost, expected frequency and accuracy of each diagnostic was given a grade from 1 to 10, where 10 is highest. A high benefit means that, if the diagnostic is accurate, the expected performance improvement is high. A high cost means that turning this diagnostic on leads to high slowdown. A high frequency means that we expect this to occur relatively often. A high accuracy means that the diagnostic is unlikely to be wrong. These grades are not perfect. They are just meant to guide users with specific needs or time budgets.

Group	Flag	Benefit	Cost	Freq.	Implemented	
CONTAINERS	HASHTABLE_TOO_SMALL	1			10	yes
	HASHTABLE_TOO_LARGE	1			10	yes
	INEFFICIENT_HASH	3			10	yes
	VECTOR_TOO_SMALL	1			10	yes
	VECTOR_TOO_LARGE	1			10	yes
	VECTOR_TO_HASHTABLE	7			10	no
	HASHTABLE_TO_VECTOR	7			10	no
	VECTOR_TO_LIST	5			10	yes
	LIST_TO_VECTOR	5			10	no
		ORDERED_TO_UNORDERED	5			10
ALGORITHMS	SORT	7	8		7	no
LOCALITY	SOFTWARE_PREFETCH	8			5	no
	RBTREE_LOCALITY	4	8		5	no
	FALSE_SHARING	8	10		10	no

Table 19.2: Profile Diagnostics

19.7.1 Diagnostic Template

- *Switch:* `_GLIBCXX_PROFILE_<diagnostic>`.
- *Goal:* What problem will it diagnose?
- *Fundamentals:*. What is the fundamental reason why this is a problem
- *Sample runtime reduction:* Percentage reduction in execution time. When reduction is more than a constant factor, describe the reduction rate formula.
- *Recommendation:* What would the advise look like?
- *To instrument:* What stdlibc++ components need to be instrumented?
- *Analysis:* How do we decide when to issue the advice?
- *Cost model:* How do we measure benefits? Math goes here.
- *Example:*

```
program code
...
advice sample
```

19.7.2 Containers

Switch: `_GLIBCXX_PROFILE_CONTAINERS`.

19.7.2.1 Hashtable Too Small

- *Switch:* `_GLIBCXX_PROFILE_HASHTABLE_TOO_SMALL`.
- *Goal:* Detect hashtables with many rehash operations, small construction size and large destruction size.
- *Fundamentals:* Rehash is very expensive. Read content, follow chains within bucket, evaluate hash function, place at new location in different order.
- *Sample runtime reduction:* 36%. Code similar to example below.
- *Recommendation:* Set initial size to N at construction site S.
- *To instrument:* `unordered_set`, `unordered_map` constructor, destructor, rehash.
- *Analysis:* For each dynamic instance of `unordered_[multi]set|map`, record initial size and call context of the constructor. Record size increase, if any, after each relevant operation such as `insert`. Record the estimated rehash cost.
- *Cost model:* Number of individual rehash operations * cost per rehash.
- *Example:*

```
1 unordered_set<int> us;
2 for (int k = 0; k < 1000000; ++k) {
3   us.insert(k);
4 }

foo.cc:1: advice: Changing initial unordered_set size from 10 to 1000000 saves 1025530 ↔
  rehash operations.
```

19.7.2.2 Hashtable Too Large

- *Switch:* `_GLIBCXX_PROFILE_HASHTABLE_TOO_LARGE`.
- *Goal:* Detect hashtables which are never filled up because fewer elements than reserved are ever inserted.
- *Fundamentals:* Save memory, which is good in itself and may also improve memory reference performance through fewer cache and TLB misses.
- *Sample runtime reduction:* unknown.
- *Recommendation:* Set initial size to N at construction site S.
- *To instrument:* `unordered_set`, `unordered_map` constructor, destructor, rehash.
- *Analysis:* For each dynamic instance of `unordered_[multi]set|map`, record initial size and call context of the constructor, and correlate it with its size at destruction time.
- *Cost model:* Number of iteration operations + memory saved.
- *Example:*

```
1 vector<unordered_set<int>> v(100000, unordered_set<int>(100)) ;
2 for (int k = 0; k < 100000; ++k) {
3   for (int j = 0; j < 10; ++j) {
4     v[k].insert(k + j);
5   }
6 }

foo.cc:1: advice: Changing initial unordered_set size from 100 to 10 saves N
bytes of memory and M iteration steps.
```

19.7.2.3 Inefficient Hash

- *Switch:* `_GLIBCXX_PROFILE_INEFFICIENT_HASH`.
- *Goal:* Detect hashtables with polarized distribution.
- *Fundamentals:* A non-uniform distribution may lead to long chains, thus possibly increasing complexity by a factor up to the number of elements.
- *Sample runtime reduction:* factor up to container size.
- *Recommendation:* Change hash function for container built at site S. Distribution score = N. Access score = S. Longest chain = C, in bucket B.
- *To instrument:* `unordered_set`, `unordered_map` constructor, destructor, [], insert, iterator.
- *Analysis:* Count the exact number of link traversals.
- *Cost model:* Total number of links traversed.
- *Example:*

```
class dumb_hash {
public:
    size_t operator() (int i) const { return 0; }
};
...
unordered_set<int, dumb_hash> hs;
...
for (int i = 0; i < COUNT; ++i) {
    hs.find(i);
}
```

19.7.2.4 Vector Too Small

- *Switch:* `_GLIBCXX_PROFILE_VECTOR_TOO_SMALL`.
- *Goal:* Detect vectors with many resize operations, small construction size and large destruction size..
- *Fundamentals:* Resizing can be expensive. Copying large amounts of data takes time. Resizing many small vectors may have allocation overhead and affect locality.
- *Sample runtime reduction:* %.
- *Recommendation:* Set initial size to N at construction site S.
- *To instrument:* `vector`.
- *Analysis:* For each dynamic instance of `vector`, record initial size and call context of the constructor. Record size increase, if any, after each relevant operation such as `push_back`. Record the estimated resize cost.
- *Cost model:* Total number of words copied * time to copy a word.
- *Example:*

```
1 vector<int> v;
2 for (int k = 0; k < 1000000; ++k) {
3     v.push_back(k);
4 }
```

```
foo.cc:1: advice: Changing initial vector size from 10 to 1000000 saves
copying 4000000 bytes and 20 memory allocations and deallocations.
```

19.7.2.5 Vector Too Large

- *Switch:* `_GLIBCXX_PROFILE_VECTOR_TOO_LARGE`
- *Goal:* Detect vectors which are never filled up because fewer elements than reserved are ever inserted.
- *Fundamentals:* Save memory, which is good in itself and may also improve memory reference performance through fewer cache and TLB misses.
- *Sample runtime reduction:* %.
- *Recommendation:* Set initial size to N at construction site S.
- *To instrument:* `vector`.
- *Analysis:* For each dynamic instance of `vector`, record initial size and call context of the constructor, and correlate it with its size at destruction time.
- *Cost model:* Total amount of memory saved.
- *Example:*

```

1 vector<vector<int>> v(100000, vector<int>(100)) ;
2 for (int k = 0; k < 100000; ++k) {
3     for (int j = 0; j < 10; ++j) {
4         v[k].insert(k + j);
5     }
6 }

```

```

foo.cc:1: advice: Changing initial vector size from 100 to 10 saves N
bytes of memory and may reduce the number of cache and TLB misses.

```

19.7.2.6 Vector to Hashtable

- *Switch:* `_GLIBCXX_PROFILE_VECTOR_TO_HASHTABLE`.
- *Goal:* Detect uses of `vector` that can be substituted with `unordered_set` to reduce execution time.
- *Fundamentals:* Linear search in a vector is very expensive, whereas searching in a hashtable is very quick.
- *Sample runtime reduction:* factor up to container size.
- *Recommendation:* Replace `vector` with `unordered_set` at site S.
- *To instrument:* `vector` operations and access methods.
- *Analysis:* For each dynamic instance of `vector`, record call context of the constructor. Issue the advice only if the only methods called on this `vector` are `push_back`, `insert` and `find`.
- *Cost model:* $\text{Cost}(\text{vector}::\text{push_back}) + \text{cost}(\text{vector}::\text{insert}) + \text{cost}(\text{find}, \text{vector}) - \text{cost}(\text{unordered_set}::\text{insert}) + \text{cost}(\text{unordered_set}::\text{find})$
- *Example:*

```

1 vector<int> v;
...
2 for (int i = 0; i < 1000; ++i) {
3     find(v.begin(), v.end(), i);
4 }

```

```

foo.cc:1: advice: Changing "vector" to "unordered_set" will save about 500,000
comparisons.

```

19.7.2.7 Hashtable to Vector

- *Switch:* `_GLIBCXX_PROFILE_HASHTABLE_TO_VECTOR`.
- *Goal:* Detect uses of `unordered_set` that can be substituted with `vector` to reduce execution time.
- *Fundamentals:* Hashtable iterator is slower than vector iterator.
- *Sample runtime reduction:* 95%.
- *Recommendation:* Replace `unordered_set` with `vector` at site S.
- *To instrument:* `unordered_set` operations and access methods.
- *Analysis:* For each dynamic instance of `unordered_set`, record call context of the constructor. Issue the advice only if the number of `find`, `insert` and `[]` operations on this `unordered_set` are small relative to the number of elements, and methods `begin` or `end` are invoked (suggesting iteration).
- *Cost model:* Number of .
- *Example:*

```

1 unordered_set<int> us;
...
2 int s = 0;
3 for (unordered_set<int>::iterator it = us.begin(); it != us.end(); ++it) {
4     s += *it;
5 }

```

```
foo.cc:1: advice: Changing "unordered_set" to "vector" will save about N
indirections and may achieve better data locality.
```

19.7.2.8 Vector to List

- *Switch:* `_GLIBCXX_PROFILE_VECTOR_TO_LIST`.
- *Goal:* Detect cases where `vector` could be substituted with `list` for better performance.
- *Fundamentals:* Inserting in the middle of a vector is expensive compared to inserting in a list.
- *Sample runtime reduction:* factor up to container size.
- *Recommendation:* Replace `vector` with `list` at site S.
- *To instrument:* `vector` operations and access methods.
- *Analysis:* For each dynamic instance of `vector`, record the call context of the constructor. Record the overhead of each `insert` operation based on current size and insert position. Report instance with high insertion overhead.
- *Cost model:* $(\text{Sum}(\text{cost}(\text{vector}::\text{method})) - \text{Sum}(\text{cost}(\text{list}::\text{method})), \text{for method in } [\text{push_back}, \text{insert}, \text{erase}]) + (\text{Cost}(\text{iterate vector}) - \text{Cost}(\text{iterate list}))$
- *Example:*

```

1 vector<int> v;
2 for (int i = 0; i < 10000; ++i) {
3     v.insert(v.begin(), i);
4 }

```

```
foo.cc:1: advice: Changing "vector" to "list" will save about 5,000,000
operations.
```

19.7.2.9 List to Vector

- *Switch:* `_GLIBCXX_PROFILE_LIST_TO_VECTOR`.
- *Goal:* Detect cases where `list` could be substituted with `vector` for better performance.
- *Fundamentals:* Iterating through a vector is faster than through a list.
- *Sample runtime reduction:* 64%.
- *Recommendation:* Replace `list` with `vector` at site S.
- *To instrument:* `vector` operations and access methods.
- *Analysis:* Issue the advice if there are no `insert` operations.
- *Cost model:* $(\text{Sum}(\text{cost}(\text{vector}::\text{method})) - \text{Sum}(\text{cost}(\text{list}::\text{method}))),$ for `method` in `[push_back, insert, erase]` + $(\text{Cost}(\text{iterate vector}) - \text{Cost}(\text{iterate list}))$
- *Example:*

```

1 list<int> l;
...
2 int sum = 0;
3 for (list<int>::iterator it = l.begin(); it != l.end(); ++it) {
4     sum += *it;
5 }

foo.cc:1: advice: Changing "list" to "vector" will save about 1000000 indirect
memory references.
```

19.7.2.10 List to Forward List (Slist)

- *Switch:* `_GLIBCXX_PROFILE_LIST_TO_SLIST`.
- *Goal:* Detect cases where `list` could be substituted with `forward_list` for better performance.
- *Fundamentals:* The memory footprint of a `forward_list` is smaller than that of a `list`. This has beneficial effects on memory subsystem, e.g., fewer cache misses.
- *Sample runtime reduction:* 40%. Note that the reduction is only noticeable if the size of the `forward_list` node is in fact larger than that of the `list` node. For memory allocators with size classes, you will only notice an effect when the two node sizes belong to different allocator size classes.
- *Recommendation:* Replace `list` with `forward_list` at site S.
- *To instrument:* `list` operations and iteration methods.
- *Analysis:* Issue the advice if there are no `backwards` traversals or insertion before a given node.
- *Cost model:* Always true.
- *Example:*

```

1 list<int> l;
...
2 int sum = 0;
3 for (list<int>::iterator it = l.begin(); it != l.end(); ++it) {
4     sum += *it;
5 }

foo.cc:1: advice: Change "list" to "forward_list".
```

19.7.2.11 Ordered to Unordered Associative Container

- *Switch:* `_GLIBCXX_PROFILE_ORDERED_TO_UNORDERED`.
- *Goal:* Detect cases where ordered associative containers can be replaced with unordered ones.
- *Fundamentals:* Insert and search are quicker in a hashtable than in a red-black tree.
- *Sample runtime reduction:* 52%.
- *Recommendation:* Replace `set` with `unordered_set` at site S.
- *To instrument:* `set`, `multiset`, `map`, `multimap` methods.
- *Analysis:* Issue the advice only if we are not using operator `++` on any iterator on a particular `[multi]set|map`.
- *Cost model:* $(\text{Sum}(\text{cost}(\text{hashtable}::\text{method})) - \text{Sum}(\text{cost}(\text{rbtree}::\text{method})))$, for method in `[insert, erase, find]` + $(\text{Cost}(\text{iterate hashtable}) - \text{Cost}(\text{iterate rbtree}))$
- *Example:*

```

1 set<int> s;
2 for (int i = 0; i < 100000; ++i) {
3     s.insert(i);
4 }
5 int sum = 0;
6 for (int i = 0; i < 100000; ++i) {
7     sum += *s.find(i);
8 }

```

19.7.3 Algorithms

Switch: `_GLIBCXX_PROFILE_ALGORITHMS`.

19.7.3.1 Sort Algorithm Performance

- *Switch:* `_GLIBCXX_PROFILE_SORT`.
- *Goal:* Give measure of sort algorithm performance based on actual input. For instance, advise Radix Sort over Quick Sort for a particular call context.
- *Fundamentals:* See papers: [A framework for adaptive algorithm selection in STAPL](#) and [Optimizing Sorting with Machine Learning Algorithms](#).
- *Sample runtime reduction:* 60%.
- *Recommendation:* Change sort algorithm at site S from X Sort to Y Sort.
- *To instrument:* `sort` algorithm.
- *Analysis:* Issue the advice if the cost model tells us that another sort algorithm would do better on this input. Requires us to know what algorithm we are using in our sort implementation in release mode.
- *Cost model:* $\text{Runtime}(\text{algo})$ for algo in `[radix, quick, merge, ...]`
- *Example:*

19.7.4 Data Locality

Switch: `_GLIBCXX_PROFILE_LOCALITY`.

19.7.4.1 Need Software Prefetch

- *Switch:* `_GLIBCXX_PROFILE_SOFTWARE_PREFETCH`.
- *Goal:* Discover sequences of indirect memory accesses that are not regular, thus cannot be predicted by hardware prefetchers.
- *Fundamentals:* Indirect references are hard to predict and are very expensive when they miss in caches.
- *Sample runtime reduction:* 25%.
- *Recommendation:* Insert prefetch instruction.
- *To instrument:* Vector iterator and access operator `[]`.
- *Analysis:* First, get cache line size and page size from system. Then record iterator dereference sequences for which the value is a pointer. For each sequence within a container, issue a warning if successive pointer addresses are not within cache lines and do not form a linear pattern (otherwise they may be prefetched by hardware). If they also step across page boundaries, make the warning stronger.

The same analysis applies to containers other than vector. However, we cannot give the same advice for linked structures, such as list, as there is no random access to the *n*-th element. The user may still be able to benefit from this information, for instance by employing frays (user level light weight threads) to hide the latency of chasing pointers.

This analysis is a little oversimplified. A better cost model could be created by understanding the capability of the hardware prefetcher. This model could be trained automatically by running a set of synthetic cases.

- *Cost model:* Total distance between pointer values of successive elements in vectors of pointers.
- *Example:*

```

1 int zero = 0;
2 vector<int*> v(10000000, &zero);
3 for (int k = 0; k < 10000000; ++k) {
4   v[random() % 10000000] = new int(k);
5 }
6 for (int j = 0; j < 10000000; ++j) {
7   count += (*v[j] == 0 ? 0 : 1);
8 }

foo.cc:7: advice: Insert prefetch instruction.
```

19.7.4.2 Linked Structure Locality

- *Switch:* `_GLIBCXX_PROFILE_RBTREE_LOCALITY`.
- *Goal:* Give measure of locality of objects stored in linked structures (lists, red-black trees and hashtables) with respect to their actual traversal patterns.
- *Fundamentals:* Allocation can be tuned to a specific traversal pattern, to result in better data locality. See paper: [Custom Memory Allocation for Free](#).
- *Sample runtime reduction:* 30%.
- *Recommendation:* High scatter score *N* for container built at site *S*. Consider changing allocation sequence or choosing a structure conscious allocator.
- *To instrument:* Methods of all containers using linked structures.
- *Analysis:* First, get cache line size and page size from system. Then record the number of successive elements that are on different line or page, for each traversal method such as `find`. Give advice only if the ratio between this number and the number of total node hops is above a threshold.
- *Cost model:* `Sum(same_cache_line(this,previous))`

- *Example:*

```

1  set<int> s;
2  for (int i = 0; i < 10000000; ++i) {
3    s.insert(i);
4  }
5  set<int> s1, s2;
6  for (int i = 0; i < 10000000; ++i) {
7    s1.insert(i);
8    s2.insert(i);
9  }
...
// Fast, better locality.
10 for (set<int>::iterator it = s.begin(); it != s.end(); ++it) {
11   sum += *it;
12 }
// Slow, elements are further apart.
13 for (set<int>::iterator it = s1.begin(); it != s1.end(); ++it) {
14   sum += *it;
15 }

```

foo.cc:5: advice: High scatter score NNN for set built here. Consider changing the allocation sequence or switching to a structure conscious allocator.

19.7.5 Multithreaded Data Access

The diagnostics in this group are not meant to be implemented short term. They require compiler support to know when container elements are written to. Instrumentation can only tell us when elements are referenced.

Switch: `_GLIBCXX_PROFILE_MULTITHREADED`.

19.7.5.1 Data Dependence Violations at Container Level

- *Switch:* `_GLIBCXX_PROFILE_DDTEST`.
- *Goal:* Detect container elements that are referenced from multiple threads in the parallel region or across parallel regions.
- *Fundamentals:* Sharing data between threads requires communication and perhaps locking, which may be expensive.
- *Sample runtime reduction:* ?%.
- *Recommendation:* Change data distribution or parallel algorithm.
- *To instrument:* Container access methods and iterators.
- *Analysis:* Keep a shadow for each container. Record iterator dereferences and container member accesses. Issue advice for elements referenced by multiple threads. See paper: [The LRPD test: speculative run-time parallelization of loops with privatization and reduction parallelization](#).
- *Cost model:* Number of accesses to elements referenced from multiple threads
- *Example:*

19.7.5.2 False Sharing

- *Switch:* `_GLIBCXX_PROFILE_FALSE_SHARING`.
- *Goal:* Detect elements in the same container which share a cache line, are written by at least one thread, and accessed by different threads.
- *Fundamentals:* Under these assumptions, cache protocols require communication to invalidate lines, which may be expensive.
- *Sample runtime reduction:* 68%.
- *Recommendation:* Reorganize container or use padding to avoid false sharing.
- *To instrument:* Container access methods and iterators.
- *Analysis:* First, get the cache line size. For each shared container, record all the associated iterator dereferences and member access methods with the thread id. Compare the address lists across threads to detect references in two different threads to the same cache line. Issue a warning only if the ratio to total references is significant. Do the same for iterator dereference values if they are pointers.
- *Cost model:* Number of accesses to same cache line from different threads.
- *Example:*

```

1   vector<int> v(2, 0);
2   #pragma omp parallel for shared(v, SIZE) schedule(static, 1)
3   for (i = 0; i < SIZE; ++i) {
4       v[i % 2] += i;
5   }

OMP_NUM_THREADS=2 ./a.out
foo.cc:1: advice: Change container structure or padding to avoid false
sharing in multithreaded access at foo.cc:4.  Detected N shared cache lines.
```

19.7.6 Statistics

Switch: `_GLIBCXX_PROFILE_STATISTICS`.

In some cases the cost model may not tell us anything because the costs appear to offset the benefits. Consider the choice between a vector and a list. When there are both inserts and iteration, an automatic advice may not be issued. However, the programmer may still be able to make use of this information in a different way.

This diagnostic will not issue any advice, but it will print statistics for each container construction site. The statistics will contain the cost of each operation actually performed on the container.

19.8 Bibliography

- [54] Lixia LiuSilvius Rus, Copyright © 2009 , Proceedings of the 2009 International Symposium on Code Generation and Optimization .

Chapter 20

The `mt_allocator`

20.1 Intro

The `mt` allocator [hereinafter referred to simply as "the allocator"] is a fixed size (power of two) allocator that was initially developed specifically to suit the needs of multi threaded applications [hereinafter referred to as an MT application]. Over time the allocator has evolved and been improved in many ways, in particular it now also does a good job in single threaded applications [hereinafter referred to as a ST application]. (Note: In this document, when referring to single threaded applications this also includes applications that are compiled with `gcc` without thread support enabled. This is accomplished using `ifdef`'s on `__GTHREADS`). This allocator is tunable, very flexible, and capable of high-performance.

The aim of this document is to describe - from an application point of view - the "inner workings" of the allocator.

20.2 Design Issues

20.2.1 Overview

There are three general components to the allocator: a datum describing the characteristics of the memory pool, a policy class containing this pool that links instantiation types to common or individual pools, and a class inheriting from the policy class that is the actual allocator.

The datum describing pools characteristics is

```
template<bool _Thread>
class __pool
```

This class is parametrized on thread support, and is explicitly specialized for both multiple threads (with `bool==true`) and single threads (via `bool==false`.) It is possible to use a custom pool datum instead of the default class that is provided.

There are two distinct policy classes, each of which can be used with either type of underlying pool datum.

```
template<bool _Thread>
struct __common_pool_policy

template<typename _Tp, bool _Thread>
struct __per_type_pool_policy
```

The first policy, `__common_pool_policy`, implements a common pool. This means that allocators that are instantiated with different types, say `char` and `long` will both use the same pool. This is the default policy.

The second policy, `__per_type_pool_policy`, implements a separate pool for each instantiating type. Thus, `char` and `long` will use separate pools. This allows per-type tuning, for instance.

Putting this all together, the actual allocator class is

```
template<typename _Tp, typename _Poolp = __default_policy>
class __mt_alloc : public __mt_alloc_base<_Tp>, _Poolp
```

This class has the interface required for standard library allocator classes, namely member functions `allocate` and `deallocate`, plus others.

20.3 Implementation

20.3.1 Tunable Parameters

Certain allocation parameters can be modified, or tuned. There exists a nested struct `__pool_base::_Tune` that contains all these parameters, which include settings for

- Alignment
- Maximum bytes before calling `::operator new` directly
- Minimum bytes
- Size of underlying global allocations
- Maximum number of supported threads
- Migration of deallocations to the global free list
- Shunt for global `new` and `delete`

Adjusting parameters for a given instance of an allocator can only happen before any allocations take place, when the allocator itself is initialized. For instance:

```
#include <ext/mt_allocator.h>

struct pod
{
    int i;
    int j;
};

int main()
{
    typedef pod value_type;
    typedef __gnu_cxx::__mt_alloc<value_type> allocator_type;
    typedef __gnu_cxx::__pool_base::_Tune tune_type;

    tune_type t_default;
    tune_type t_opt(16, 5120, 32, 5120, 20, 10, false);
    tune_type t_single(16, 5120, 32, 5120, 1, 10, false);

    tune_type t;
    t = allocator_type::_M_get_options();
    allocator_type::_M_set_options(t_opt);
    t = allocator_type::_M_get_options();

    allocator_type a;
    allocator_type::pointer p1 = a.allocate(128);
    allocator_type::pointer p2 = a.allocate(5128);

    a.deallocate(p1, 128);
    a.deallocate(p2, 5128);
```

```

    return 0;
}

```

20.3.2 Initialization

The static variables (pointers to freelists, tuning parameters etc) are initialized as above, or are set to the global defaults.

The very first `allocate()` call will always call the `_S_initialize_once()` function. In order to make sure that this function is called exactly once we make use of a `__gthread_once` call in MT applications and check a static bool (`_S_init`) in ST applications.

The `_S_initialize()` function: - If the `GLIBCXX_FORCE_NEW` environment variable is set, it sets the bool `_S_force_new` to true and then returns. This will cause subsequent calls to `allocate()` to return memory directly from a `new()` call, and `deallocate` will only do a `delete()` call.

- If the `GLIBCXX_FORCE_NEW` environment variable is not set, both ST and MT applications will: - Calculate the number of bins needed. A bin is a specific power of two size of bytes. I.e., by default the allocator will deal with requests of up to 128 bytes (or whatever the value of `_S_max_bytes` is when `_S_init()` is called). This means that there will be bins of the following sizes (in bytes): 1, 2, 4, 8, 16, 32, 64, 128. - Create the `_S_binmap` array. All requests are rounded up to the next "large enough" bin. I.e., a request for 29 bytes will cause a block from the "32 byte bin" to be returned to the application. The purpose of `_S_binmap` is to speed up the process of finding out which bin to use. I.e., the value of `_S_binmap[29]` is initialized to 5 (bin 5 = 32 bytes).

- Create the `_S_bin` array. This array consists of `bin_records`. There will be as many `bin_records` in this array as the number of bins that we calculated earlier. I.e., if `_S_max_bytes = 128` there will be 8 entries. Each `bin_record` is then initialized: - `bin_record->first` = An array of pointers to `block_records`. There will be as many `block_records` pointers as there are maximum number of threads (in a ST application there is only 1 thread, in a MT application there are `_S_max_threads`). This holds the pointer to the first free block for each thread in this bin. I.e., if we would like to know where the first free block of size 32 for thread number 3 is we would look this up by: `_S_bin[5].first[3]` The above created `block_record` pointers members are now initialized to their initial values. I.e. `_S_bin[n].first[n] = NULL;`

- Additionally a MT application will: - Create a list of free thread id's. The pointer to the first entry is stored in `_S_thread_freelist_first`. The reason for this approach is that the `__gthread_self()` call will not return a value that corresponds to the maximum number of threads allowed but rather a process id number or something else. So what we do is that we create a list of `thread_records`. This list is `_S_max_threads` long and each entry holds a `size_t` `thread_id` which is initialized to 1, 2, 3, 4, 5 and so on up to `_S_max_threads`. Each time a thread calls `allocate()` or `deallocate()` we call `_S_get_thread_id()` which looks at the value of `_S_thread_key` which is a thread local storage pointer. If this is `NULL` we know that this is a newly created thread and we pop the first entry from this list and saves the pointer to this record in the `_S_thread_key` variable. The next time we will get the pointer to the `thread_record` back and we use the `thread_record->thread_id` as identification. I.e., the first thread that calls `allocate` will get the first record in this list and thus be thread number 1 and will then find the pointer to its first free 32 byte block in `_S_bin[5].first[1]` When we create the `_S_thread_key` we also define a destructor (`_S_thread_key_destr`) which means that when the thread dies, this `thread_record` is returned to the front of this list and the thread id can then be reused if a new thread is created. This list is protected by a mutex (`_S_thread_freelist_mutex`) which is only locked when records are removed or added to the list.

- Initialize the free and used counters of each `bin_record`: - `bin_record->free` = An array of `size_t`. This keeps track of the number of blocks on a specific thread's freelist in each bin. I.e., if a thread has 12 32-byte blocks on it's freelists and allocates one of these, this counter would be decreased to 11. - `bin_record->used` = An array of `size_t`. This keeps track of the number of blocks currently in use of this size by this thread. I.e., if a thread has made 678 requests (and no deallocations...) of 32-byte blocks this counter will read 678. The above created arrays are now initialized with their initial values. I.e. `_S_bin[n].free[n] = 0;`

- Initialize the mutex of each `bin_record`: The `bin_record->mutex` is used to protect the global freelist. This concept of a global freelist is explained in more detail in the section "A multi threaded example", but basically this mutex is locked whenever a block of memory is retrieved or returned to the global freelist for this specific bin. This only occurs when a number of blocks are grabbed from the global list to a thread specific list or when a thread decides to return some blocks to the global freelist.

20.3.3 Deallocation Notes

Notes about deallocation. This allocator does not explicitly release memory. Because of this, memory debugging programs like `valgrind` or `purify` may notice leaks: sorry about this inconvenience. Operating systems will reclaim allocated memory at program

termination anyway. If sidestepping this kind of noise is desired, there are three options: use an allocator, like `new_allocator` that releases memory while debugging, use `GLIBCXX_FORCE_NEW` to bypass the allocator's internal pools, or use a custom pool datum that releases resources on destruction.

On systems with the function `__cxa_atexit`, the allocator can be forced to free all memory allocated before program termination with the member function `__pool_type::_M_destroy`. However, because this member function relies on the precise and exactly-conforming ordering of static destructors, including those of a static local `__pool` object, it should not be used, ever, on systems that don't have the necessary underlying support. In addition, in practice, forcing deallocation can be tricky, as it requires the `__pool` object to be fully-constructed before the object that uses it is fully constructed. For most (but not all) STL containers, this works, as an instance of the allocator is constructed as part of a container's constructor. However, this assumption is implementation-specific, and subject to change. For an example of a pool that frees memory, see the following [example](#).

20.4 Single Thread Example

Let's start by describing how the data on a freelist is laid out in memory. This is the first two blocks in freelist for thread id 3 in bin 3 (8 bytes):

```
+-----+
| next*  -----|--+  (_S_bin[ 3 ].first[ 3 ] points here)
|          |      |
|          |      |
+-----+-----+
| thread_id = 3 |   |
|          |      |
|          |      |
+-----+-----+
| DATA        |   | (A pointer to here is what is returned to the
|          |      |   | the application when needed)
|          |      |
|          |      |
+-----+-----+
| next*        |<--+ (If next == NULL it's the last one on the list)
|          |      |
|          |      |
+-----+-----+
| thread_id = 3 |   |
|          |      |
|          |      |
+-----+-----+
| DATA        |   |
|          |      |
|          |      |
+-----+-----+
```

With this in mind we simplify things a bit for a while and say that there is only one thread (a ST application). In this case all operations are made to what is referred to as the global pool - thread id 0 (No thread may be assigned this id since they span from 1 to `_S_max_threads` in a MT application).

When the application requests memory (calling `allocate()`) we first look at the requested size and if this is $> _S_max_bytes$ we call `new()` directly and return.

If the requested size is within limits we start by finding out from which bin we should serve this request by looking in `_S_binmap`.

A quick look at `_S_bin[bin].first[0]` tells us if there are any blocks of this size on the freelist (0). If this is not NULL - fine, just remove the block that `_S_bin[bin].first[0]` points to from the list, update `_S_bin[bin].first[0]` and return a pointer to that blocks data.

If the freelist is empty (the pointer is NULL) we must get memory from the system and build us a freelist within this memory. All requests for new memory is made in chunks of `_S_chunk_size`. Knowing the size of a `block_record` and the bytes that this bin stores we then calculate how many blocks we can create within this chunk, build the list, remove the first block, update the pointer (`_S_bin[bin].first[0]`) and return a pointer to that blocks data.

Deallocation is equally simple; the pointer is casted back to a `block_record` pointer, lookup which bin to use based on the size, add the block to the front of the global freelist and update the pointer as needed (`_S_bin[bin].first[0]`).

The decision to add deallocated blocks to the front of the freelist was made after a set of performance measurements that showed that this is roughly 10% faster than maintaining a set of "last pointers" as well.

20.5 Multiple Thread Example

In the ST example we never used the `thread_id` variable present in each block. Let's start by explaining the purpose of this in a MT application.

The concept of "ownership" was introduced since many MT applications allocate and deallocate memory to shared containers from different threads (such as a cache shared amongst all threads). This introduces a problem if the allocator only returns memory to the current threads freelist (I.e., there might be one thread doing all the allocation and thus obtaining ever more memory from the system and another thread that is getting a longer and longer freelist - this will in the end consume all available memory).

Each time a block is moved from the global list (where ownership is irrelevant), to a threads freelist (or when a new freelist is built from a chunk directly onto a threads freelist or when a deallocation occurs on a block which was not allocated by the same thread id as the one doing the deallocation) the thread id is set to the current one.

What's the use? Well, when a deallocation occurs we can now look at the thread id and find out if it was allocated by another thread id and decrease the used counter of that thread instead, thus keeping the free and used counters correct. And keeping the free and used counters corrects is very important since the relationship between these two variables decides if memory should be returned to the global pool or not when a deallocation occurs.

When the application requests memory (calling `allocate()`) we first look at the requested size and if this is $> _S_max_bytes$ we call `new()` directly and return.

If the requested size is within limits we start by finding out from which bin we should serve this request by looking in `_S_binmap`.

A call to `_S_get_thread_id()` returns the thread id for the calling thread (and if no value has been set in `_S_thread_key`, a new id is assigned and returned).

A quick look at `_S_bin[bin].first[thread_id]` tells us if there are any blocks of this size on the current threads freelist. If this is not NULL - fine, just remove the block that `_S_bin[bin].first[thread_id]` points to from the list, update `_S_bin[bin].first[thread_id]`, update the free and used counters and return a pointer to that blocks data.

If the freelist is empty (the pointer is NULL) we start by looking at the global freelist (0). If there are blocks available on the global freelist we lock this bins mutex and move up to `block_count` (the number of blocks of this bins size that will fit into a `_S_chunk_size`) or until end of list - whatever comes first - to the current threads freelist and at the same time change the `thread_id` ownership and update the counters and pointers. When the bins mutex has been unlocked, we remove the block that `_S_bin[bin].first[thread_id]` points to from the list, update `_S_bin[bin].first[thread_id]`, update the free and used counters, and return a pointer to that blocks data.

The reason that the number of blocks moved to the current threads freelist is limited to `block_count` is to minimize the chance that a subsequent `deallocate()` call will return the excess blocks to the global freelist (based on the `_S_freelist_headroom` calculation, see below).

However if there isn't any memory on the global pool we need to get memory from the system - this is done in exactly the same way as in a single threaded application with one major difference; the list built in the newly allocated memory (of `_S_chunk_size` size) is added to the current threads freelist instead of to the global.

The basic process of a deallocation call is simple: always add the block to the front of the current threads freelist and update the counters and pointers (as described earlier with the specific check of ownership that causes the used counter of the thread that originally allocated the block to be decreased instead of the current threads counter).

And here comes the free and used counters to service. Each time a `deallocate()` call is made, the length of the current threads freelist is compared to the amount memory in use by this thread.

Let's go back to the example of an application that has one thread that does all the allocations and one that deallocates. Both these threads use say 516 32-byte blocks that was allocated during thread creation for example. Their used counters will both say 516 at this point. The allocation thread now grabs 1000 32-byte blocks and puts them in a shared container. The used counter for this thread is now 1516.

The deallocation thread now deallocates 500 of these blocks. For each deallocation made the used counter of the allocating thread is decreased and the freelist of the deallocation thread gets longer and longer. But the calculation made in `deallocate()` will limit the length of the freelist in the deallocation thread to `_S_freelist_headroom %` of it's used counter. In this case, when the freelist (given that the `_S_freelist_headroom` is at it's default value of 10%) exceeds 52 (516/10) blocks will be returned to the global pool where the allocating thread may pick them up and reuse them.

In order to reduce lock contention (since this requires this bins mutex to be locked) this operation is also made in chunks of blocks (just like when chunks of blocks are moved from the global freelist to a threads freelist mentioned above). The "formula" used can probably be improved to further reduce the risk of blocks being "bounced back and forth" between freelists.

Chapter 21

The `bitmap_allocator`

21.1 Design

As this name suggests, this allocator uses a bit-map to keep track of the used and unused memory locations for its book-keeping purposes.

This allocator will make use of 1 single bit to keep track of whether it has been allocated or not. A bit 1 indicates free, while 0 indicates allocated. This has been done so that you can easily check a collection of bits for a free block. This kind of Bitmapped strategy works best for single object allocations, and with the STL type parameterized allocators, we do not need to choose any size for the block which will be represented by a single bit. This will be the size of the parameter around which the allocator has been parameterized. Thus, close to optimal performance will result. Hence, this should be used for node based containers which call the `allocate` function with an argument of 1.

The bitmapped allocator's internal pool is exponentially growing. Meaning that internally, the blocks acquired from the Free List Store will double every time the bitmapped allocator runs out of memory.

The macro `__GTHREADS` decides whether to use Mutex Protection around every allocation/deallocation. The state of the macro is picked up automatically from the `gthr` abstraction layer.

21.2 Implementation

21.2.1 Free List Store

The Free List Store (referred to as FLS for the remaining part of this document) is the Global memory pool that is shared by all instances of the bitmapped allocator instantiated for any type. This maintains a sorted order of all free memory blocks given back to it by the bitmapped allocator, and is also responsible for giving memory to the bitmapped allocator when it asks for more.

Internally, there is a Free List threshold which indicates the Maximum number of free lists that the FLS can hold internally (cache). Currently, this value is set at 64. So, if there are more than 64 free lists coming in, then some of them will be given back to the OS using operator `delete` so that at any given time the Free List's size does not exceed 64 entries. This is done because a Binary Search is used to locate an entry in a free list when a request for memory comes along. Thus, the run-time complexity of the search would go up given an increasing size, for 64 entries however, $\lg(64) = 6$ comparisons are enough to locate the correct free list if it exists.

Suppose the free list size has reached its threshold, then the largest block from among those in the list and the new block will be selected and given back to the OS. This is done because it reduces external fragmentation, and allows the OS to use the larger blocks later in an orderly fashion, possibly merging them later. Also, on some systems, large blocks are obtained via calls to `mmap`, so giving them back to free system resources becomes most important.

The function `_S_should_i_give` decides the policy that determines whether the current block of memory should be given to the allocator for the request that it has made. That's because we may not always have exact fits for the memory size that the allocator requests. We do this mainly to prevent external fragmentation at the cost of a little internal fragmentation. Now, the value of this

21.2.4 Maximum Wasted Percentage

This has nothing to do with the algorithm per-se, only with some vales that must be chosen correctly to ensure that the allocator performs well in a real word scenario, and maintains a good balance between the memory consumption and the allocation/deallocation speed.

The formula for calculating the maximum wastage as a percentage:

$$(32 \times k + 1) / (2 \times (32 \times k + 1 + 32 \times c)) \times 100.$$

where k is the constant overhead per node (e.g., for list, it is 8 bytes, and for map it is 12 bytes) and c is the size of the base type on which the map/list is instantiated. Thus, suppose the type1 is int and type2 is double, they are related by the relation $\text{sizeof}(\text{double}) == 2 * \text{sizeof}(\text{int})$. Thus, all types must have this double size relation for this formula to work properly.

Plugging-in: For List: $k = 8$ and $c = 4$ (int and double), we get: 33.376%

For map/multimap: $k = 12$, and $c = 4$ (int and double), we get: 37.524%

Thus, knowing these values, and based on the $\text{sizeof}(\text{value_type})$, we may create a function that returns the `Max_Wastage_Percentage` for us to use.

21.2.5 allocate

The `allocate` function is specialized for single object allocation ONLY. Thus, ONLY if $n == 1$, will the `bitmap_allocator`'s specialized algorithm be used. Otherwise, the request is satisfied directly by calling operator `new`.

Suppose $n == 1$, then the allocator does the following:

1. Checks to see whether a free block exists somewhere in a region of memory close to the last satisfied request. If so, then that block is marked as allocated in the bit map and given to the user. If not, then (2) is executed.
2. Is there a free block anywhere after the current block right up to the end of the memory that we have? If so, that block is found, and the same procedure is applied as above, and returned to the user. If not, then (3) is executed.
3. Is there any block in whatever region of memory that we own free? This is done by checking
 - The use count for each super block, and if that fails then
 - The individual bit-maps for each super block.

Note: Here we are never touching any of the memory that the user will be given, and we are confining all memory accesses to a small region of memory! This helps reduce cache misses. If this succeeds then we apply the same procedure on that bit-map as (1), and return that block of memory to the user. However, if this process fails, then we resort to (4).

4. This process involves Refilling the internal exponentially growing memory pool. The said effect is achieved by calling `_S_refill_pool` which does the following:
 - Gets more memory from the Global Free List of the Required size.
 - Adjusts the size for the next call to itself.
 - Writes the appropriate headers in the bit-maps.
 - Sets the use count for that super-block just allocated to 0 (zero).
 - All of the above accounts to maintaining the basic invariant for the allocator. If the invariant is maintained, we are sure that all is well. Now, the same process is applied on the newly acquired free blocks, which are dispatched accordingly.

Thus, you can clearly see that the `allocate` function is nothing but a combination of the next-fit and first-fit algorithm optimized ONLY for single object allocations.

21.2.8 Locality

Another issue would be whether to keep the all bitmaps in a separate area in memory, or to keep them near the actual blocks that will be given out or allocated for the client. After some testing, I've decided to keep these bitmaps close to the actual blocks. This will help in 2 ways.

1. Constant time access for the bitmap themselves, since no kind of look up will be needed to find the correct bitmap list or its equivalent.
2. And also this would preserve the cache as far as possible.

So in effect, this kind of an allocator might prove beneficial from a purely cache point of view. But this allocator has been made to try and roll out the defects of the `node_allocator`, wherein the nodes get skewed about in memory, if they are not returned in the exact reverse order or in the same order in which they were allocated. Also, the `new_allocator`'s book keeping overhead is too much for small objects and single object allocations, though it preserves the locality of blocks very well when they are returned back to the allocator.

21.2.9 Overhead and Grow Policy

Expected overhead per block would be 1 bit in memory. Also, once the address of the free list has been found, the cost for allocation/deallocation would be negligible, and is supposed to be constant time. For these very reasons, it is very important to minimize the linear time costs, which include finding a free list with a free block while allocating, and finding the corresponding free list for a block while deallocating. Therefore, I have decided that the growth of the internal pool for this allocator will be exponential as compared to linear for `node_allocator`. There, linear time works well, because we are mainly concerned with speed of allocation/deallocation and memory consumption, whereas here, the allocation/deallocation part does have some linear/logarithmic complexity components in it. Thus, to try and minimize them would be a good thing to do at the cost of a little bit of memory.

Another thing to be noted is the pool size will double every time the internal pool gets exhausted, and all the free blocks have been given away. The initial size of the pool would be `sizeof(size_t) x 8` which is the number of bits in an integer, which can fit exactly in a CPU register. Hence, the term given is exponential growth of the internal pool.

Chapter 22

Policy-Based Data Structures

22.1 Intro

This is a library of policy-based elementary data structures: associative containers and priority queues. It is designed for high-performance, flexibility, semantic safety, and conformance to the corresponding containers in `std` and `std::tr1` (except for some points where it differs by design).

22.1.1 Performance Issues

An attempt is made to categorize the wide variety of possible container designs in terms of performance-impacting factors. These performance factors are translated into design policies and incorporated into container design.

There is tension between unravelling factors into a coherent set of policies. Every attempt is made to make a minimal set of factors. However, in many cases multiple factors make for long template names. Every attempt is made to alias and use typedefs in the source files, but the generated names for external symbols can be large for binary files or debuggers.

In many cases, the longer names allow capabilities and behaviours controlled by macros to also be unambiguously emitted as distinct generated names.

Specific issues found while unraveling performance factors in the design of associative containers and priority queues follow.

22.1.1.1 Associative

Associative containers depend on their composite policies to a very large extent. Implicitly hard-wiring policies can hamper their performance and limit their functionality. An efficient hash-based container, for example, requires policies for testing key equivalence, hashing keys, translating hash values into positions within the hash table, and determining when and how to resize the table internally. A tree-based container can efficiently support order statistics, i.e. the ability to query what is the order of each key within the sequence of keys in the container, but only if the container is supplied with a policy to internally update meta-data. There are many other such examples.

Ideally, all associative containers would share the same interface. Unfortunately, underlying data structures and mapping semantics differentiate between different containers. For example, suppose one writes a generic function manipulating an associative container.

```
template<typename Cntnr>
void
some_op_sequence(Cntnr& r_cnt)
{
    ...
}
```

Given this, then what can one assume about the instantiating container? The answer varies according to its underlying data structure. If the underlying data structure of `Cntnr` is based on a tree or trie, then the order of elements is well defined; otherwise, it is not, in general. If the underlying data structure of `Cntnr` is based on a collision-chaining hash table, then modifying `r_Cntnr` will not invalidate its iterators' order; if the underlying data structure is a probing hash table, then this is not the case. If the underlying data structure is based on a tree or trie, then a reference to the container can efficiently be split; otherwise, it cannot, in general. If the underlying data structure is a red-black tree, then splitting a reference to the container is exception-free; if it is an ordered-vector tree, exceptions can be thrown.

22.1.1.2 Priority Que

Priority queues are useful when one needs to efficiently access a minimum (or maximum) value as the set of values changes.

Most useful data structures for priority queues have a relatively simple structure, as they are geared toward relatively simple requirements. Unfortunately, these structures do not support access to an arbitrary value, which turns out to be necessary in many algorithms. Say, decreasing an arbitrary value in a graph algorithm. Therefore, some extra mechanism is necessary and must be invented for accessing arbitrary values. There are at least two alternatives: embedding an associative container in a priority queue, or allowing cross-referencing through iterators. The first solution adds significant overhead; the second solution requires a precise definition of iterator invalidation. Which is the next point...

Priority queues, like hash-based containers, store values in an order that is meaningless and undefined externally. For example, a `push` operation can internally reorganize the values. Because of this characteristic, describing a priority queues' iterator is difficult: on one hand, the values to which iterators point can remain valid, but on the other, the logical order of iterators can change unpredictably.

Roughly speaking, any element that is both inserted to a priority queue (e.g. through `push`) and removed from it (e.g., through `pop`), incurs a logarithmic overhead (in the amortized sense). Different underlying data structures place the actual cost differently: some are optimized for amortized complexity, whereas others guarantee that specific operations only have a constant cost. One underlying data structure might be chosen if modifying a value is frequent (Dijkstra's shortest-path algorithm), whereas a different one might be chosen otherwise. Unfortunately, an array-based binary heap - an underlying data structure that optimizes (in the amortized sense) `push` and `pop` operations, differs from the others in terms of its invalidation guarantees. Other design decisions also impact the cost and placement of the overhead, at the expense of more difference in the the kinds of operations that the underlying data structure can support. These differences pose a challenge when creating a uniform interface for priority queues.

22.1.2 Goals

Many fine associative-container libraries were already written, most notably, the C++ standard's associative containers. Why then write another library? This section shows some possible advantages of this library, when considering the challenges in the introduction. Many of these points stem from the fact that the ISO C++ process introduced associative-containers in a two-step process (first standardizing tree-based containers, only then adding hash-based containers, which are fundamentally different), did not standardize priority queues as containers, and (in our opinion) overloads the iterator concept.

22.1.2.1 Associative

22.1.2.1.1 Policy Choices

Associative containers require a relatively large number of policies to function efficiently in various settings. In some cases this is needed for making their common operations more efficient, and in other cases this allows them to support a larger set of operations

1. Hash-based containers, for example, support look-up and insertion methods (`find` and `insert`). In order to locate elements quickly, they are supplied a hash functor, which instruct how to transform a key object into some size type; a hash functor might transform "hello" into 1123002298. A hash table, though, requires transforming each key object into some size-type type in some specific domain; a hash table with a 128-long table might transform "hello" into position 63. The policy by which the hash value is transformed into a position within the table can dramatically affect performance. Hash-based containers also do not resize naturally (as opposed to tree-based containers, for example). The appropriate resize policy is unfortunately intertwined with the policy that transforms hash value into a position within the table.

2. Tree-based containers, for example, also support look-up and insertion methods, and are primarily useful when maintaining order between elements is important. In some cases, though, one can utilize their balancing algorithms for completely different purposes.

Figure A shows a tree whose each node contains two entries: a floating-point key, and some size-type *metadata* (in bold beneath it) that is the number of nodes in the sub-tree. (The root has key 0.99, and has 5 nodes (including itself) in its sub-tree.) A container based on this data structure can obviously answer efficiently whether 0.3 is in the container object, but it can also answer what is the order of 0.3 among all those in the container object: see [66].

As another example, Figure B shows a tree whose each node contains two entries: a half-open geometric line interval, and a number *metadata* (in bold beneath it) that is the largest endpoint of all intervals in its sub-tree. (The root describes the interval $[20, 36)$, and the largest endpoint in its sub-tree is 99.) A container based on this data structure can obviously answer efficiently whether $[3, 41)$ is in the container object, but it can also answer efficiently whether the container object has intervals that intersect $[3, 41)$. These types of queries are very useful in geometric algorithms and lease-management algorithms.

It is important to note, however, that as the trees are modified, their internal structure changes. To maintain these invariants, one must supply some policy that is aware of these changes. Without this, it would be better to use a linked list (in itself very efficient for these purposes).

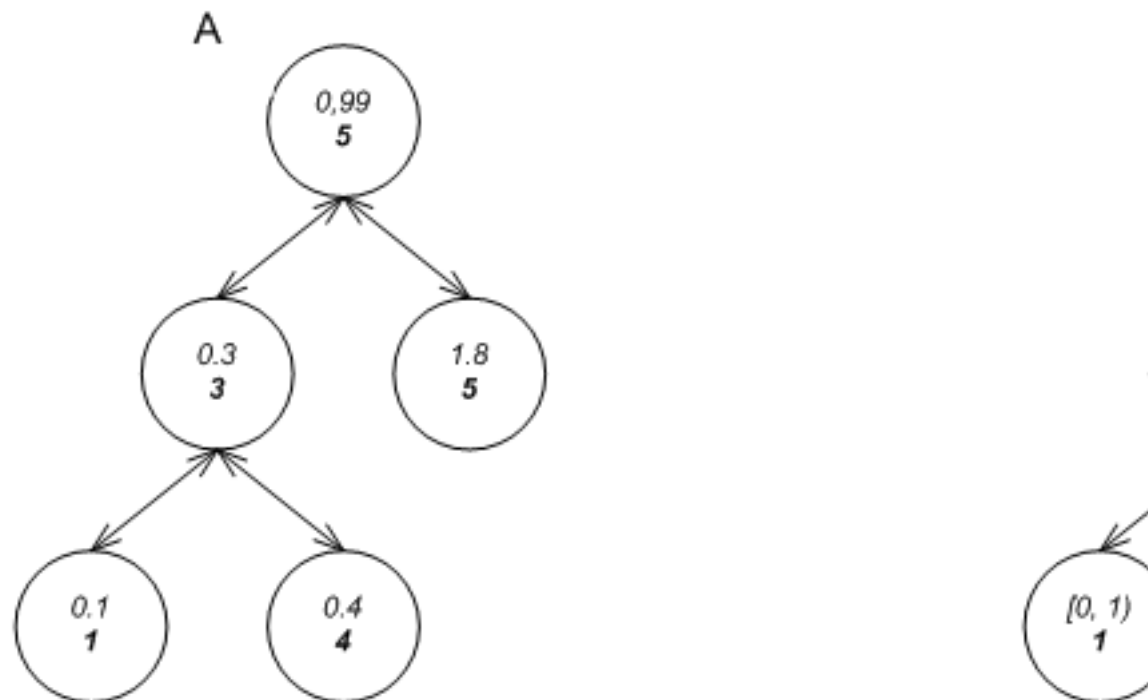

Figure 22.1: Node Invariants

22.1.2.1.2 Underlying Data Structures

The standard C++ library contains associative containers based on red-black trees and collision-chaining hash tables. These are very useful, but they are not ideal for all types of settings.

The figure below shows the different underlying data structures currently supported in this library.

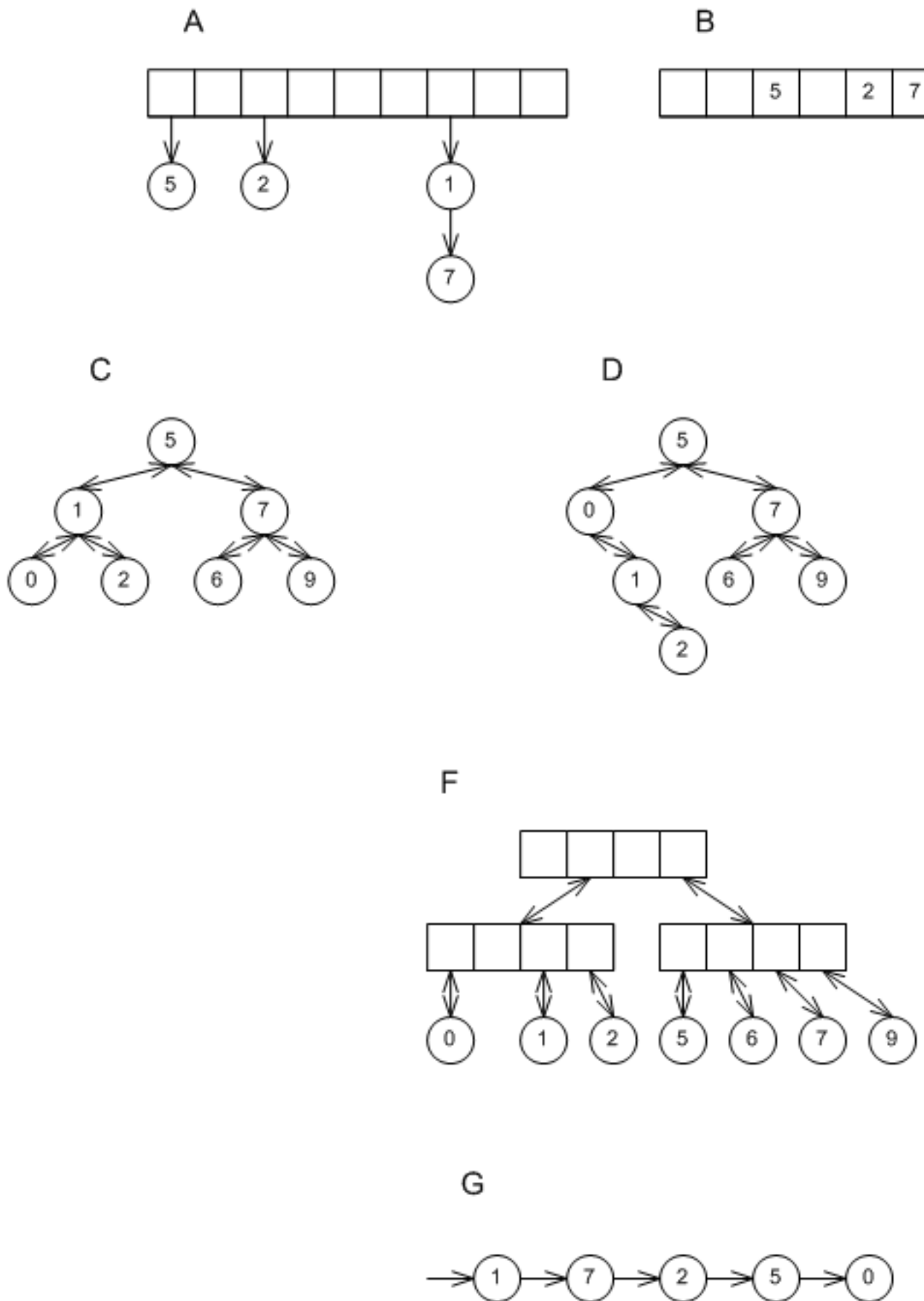

Figure 22.2: Underlying Associative Data Structures

A shows a collision-chaining hash-table, B shows a probing hash-table, C shows a red-black tree, D shows a splay tree, E shows a tree based on an ordered vector (implicit in the order of the elements), F shows a PATRICIA trie, and G shows a list-based container with update policies.

Each of these data structures has some performance benefits, in terms of speed, size or both. For now, note that vector-based trees and probing hash tables manipulate memory more efficiently than red-black trees and collision-chaining hash tables, and that list-based associative containers are very useful for constructing "multimaps".

Now consider a function manipulating a generic associative container,

```
template<class Cntnr>
int
some_op_sequence(Cntnr &r_cnt)
{
    ...
}
```

Ideally, the underlying data structure of `Cntnr` would not affect what can be done with `r_cnt`. Unfortunately, this is not the case.

For example, if `Cntnr` is `std::map`, then the function can use

```
std::for_each(r_cnt.find(foo), r_cnt.find(bar), foobar)
```

in order to apply `foobar` to all elements between `foo` and `bar`. If `Cntnr` is a hash-based container, then this call's results are undefined.

Also, if `Cntnr` is tree-based, the type and object of the comparison functor can be accessed. If `Cntnr` is hash based, these queries are nonsensical.

There are various other differences based on the container's underlying data structure. For one, they can be constructed by, and queried for, different policies. Furthermore:

1. Containers based on C, D, E and F store elements in a meaningful order; the others store elements in a meaningless (and probably time-varying) order. By implication, only containers based on C, D, E and F can support `erase` operations taking an iterator and returning an iterator to the following element without performance loss.
2. Containers based on C, D, E, and F can be split and joined efficiently, while the others cannot. Containers based on C and D, furthermore, can guarantee that this is exception-free; containers based on E cannot guarantee this.
3. Containers based on all but E can guarantee that erasing an element is exception free; containers based on E cannot guarantee this. Containers based on all but B and E can guarantee that modifying an object of their type does not invalidate iterators or references to their elements, while containers based on B and E cannot. Containers based on C, D, and E can furthermore make a stronger guarantee, namely that modifying an object of their type does not affect the order of iterators.

A unified tag and traits system (as used for the C++ standard library iterators, for example) can ease generic manipulation of associative containers based on different underlying data structures.

22.1.2.1.3 Iterators

Iterators are centric to the design of the standard library containers, because of the container/algorithm/iterator decomposition that allows an algorithm to operate on a range through iterators of some sequence. Iterators, then, are useful because they allow going over a specific *sequence*. The standard library also uses iterators for accessing a specific *element*: when an associative container returns one through `find`. The standard library consistently uses the same types of iterators for both purposes: going over a range, and accessing a specific found element. Before the introduction of hash-based containers to the standard library, this made sense (with the exception of priority queues, which are discussed later).

Using the standard associative containers together with non-order-preserving associative containers (and also because of priority-queues container), there is a possible need for different types of iterators for self-organizing containers: the iterator concept seems overloaded to mean two different things (in some cases).

22.1.2.1.3.1 Using Point Iterators for Range Operations

Suppose `cntnr` is some associative container, and say `c` is an object of type `cntnr`. Then what will be the outcome of

```
std::for_each(c.find(1), c.find(5), foo);
```

If `cntnr` is a tree-based container object, then an in-order walk will apply `foo` to the relevant elements, as in the graphic below, label A. If `c` is a hash-based container, then the order of elements between any two elements is undefined (and probably time-varying); there is no guarantee that the elements traversed will coincide with the *logical* elements between 1 and 5, as in label B.

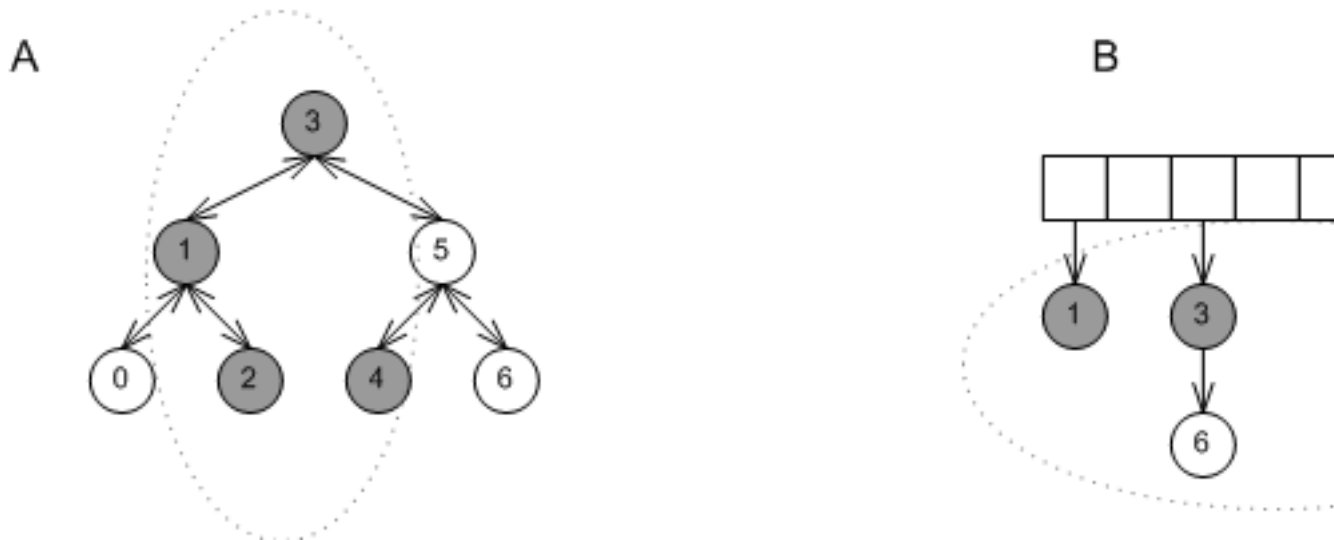

Figure 22.3: Range Iteration in Different Data Structures

In our opinion, this problem is not caused just because red-black trees are order preserving while collision-chaining hash tables are (generally) not - it is more fundamental. Most of the standard's containers order sequences in a well-defined manner that is determined by their *interface*: calling `insert` on a tree-based container modifies its sequence in a predictable way, as does calling `push_back` on a list or a vector. Conversely, collision-chaining hash tables, probing hash tables, priority queues, and list-based containers (which are very useful for "multimaps") are self-organizing data structures; the effect of each operation modifies their sequences in a manner that is (practically) determined by their *implementation*.

Consequently, applying an algorithm to a sequence obtained from most containers may or may not make sense, but applying it to a sub-sequence of a self-organizing container does not.

22.1.2.1.3.2 Cost to Point Iterators to Enable Range Operations

Suppose `c` is some collision-chaining hash-based container object, and one calls

```
c.find(3)
```

Then what composes the returned iterator?

In the graphic below, label A shows the simplest (and most efficient) implementation of a collision-chaining hash table. The little box marked `point_iterator` shows an object that contains a pointer to the element's node. Note that this "iterator" has no way to move to the next element (it cannot support `operator++`). Conversely, the little box marked `iterator` stores both a pointer to the element, as well as some other information (the bucket number of the element). the second iterator, then, is "heavier" than the first one- it requires more time and space. If we were to use a different container to cross-reference into this hash-table using these iterators - it would take much more space. As noted above, nothing much can be done by incrementing these iterators, so why is this extra information needed?

Alternatively, one might create a collision-chaining hash-table where the lists might be linked, forming a monolithic total-element list, as in the graphic below, label B. Here the iterators are as light as can be, but the hash-table's operations are more complicated.

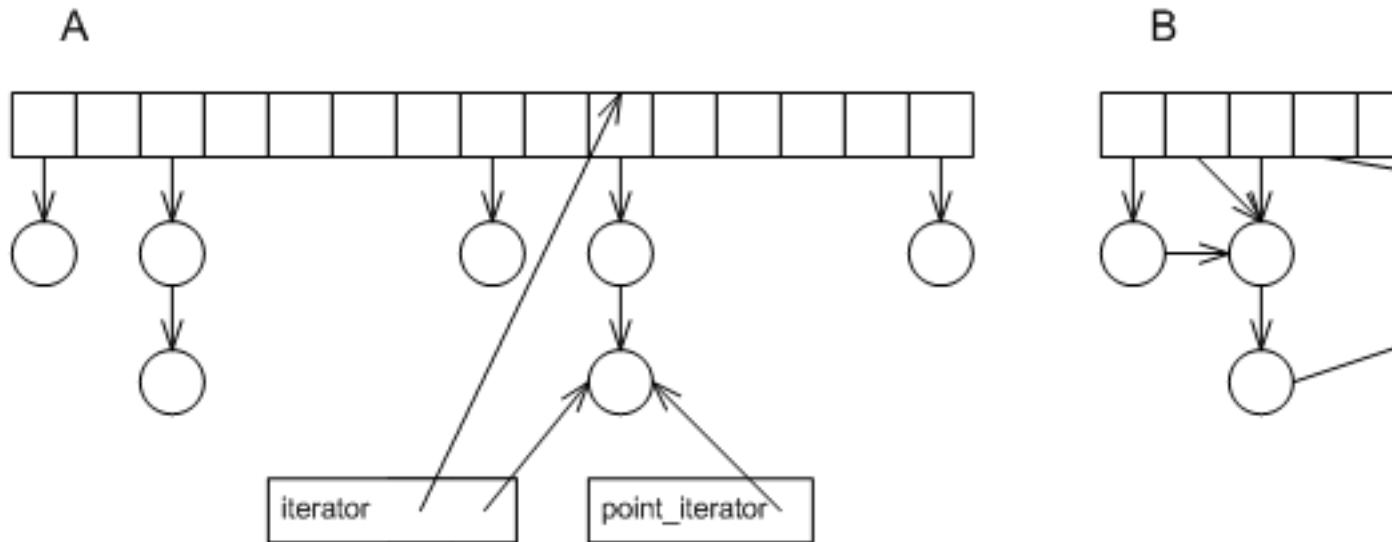

Figure 22.4: Point Iteration in Hash Data Structures

It should be noted that containers based on collision-chaining hash-tables are not the only ones with this type of behavior; many other self-organizing data structures display it as well.

22.1.2.1.3.3 Invalidation Guarantees

Consider the following snippet:

```
it = c.find(3);
c.erase(5);
```

Following the call to `erase`, what is the validity of `it`: can it be de-referenced? can it be incremented?

The answer depends on the underlying data structure of the container. The graphic below shows three cases: A1 and A2 show a red-black tree; B1 and B2 show a probing hash-table; C1 and C2 show a collision-chaining hash table.

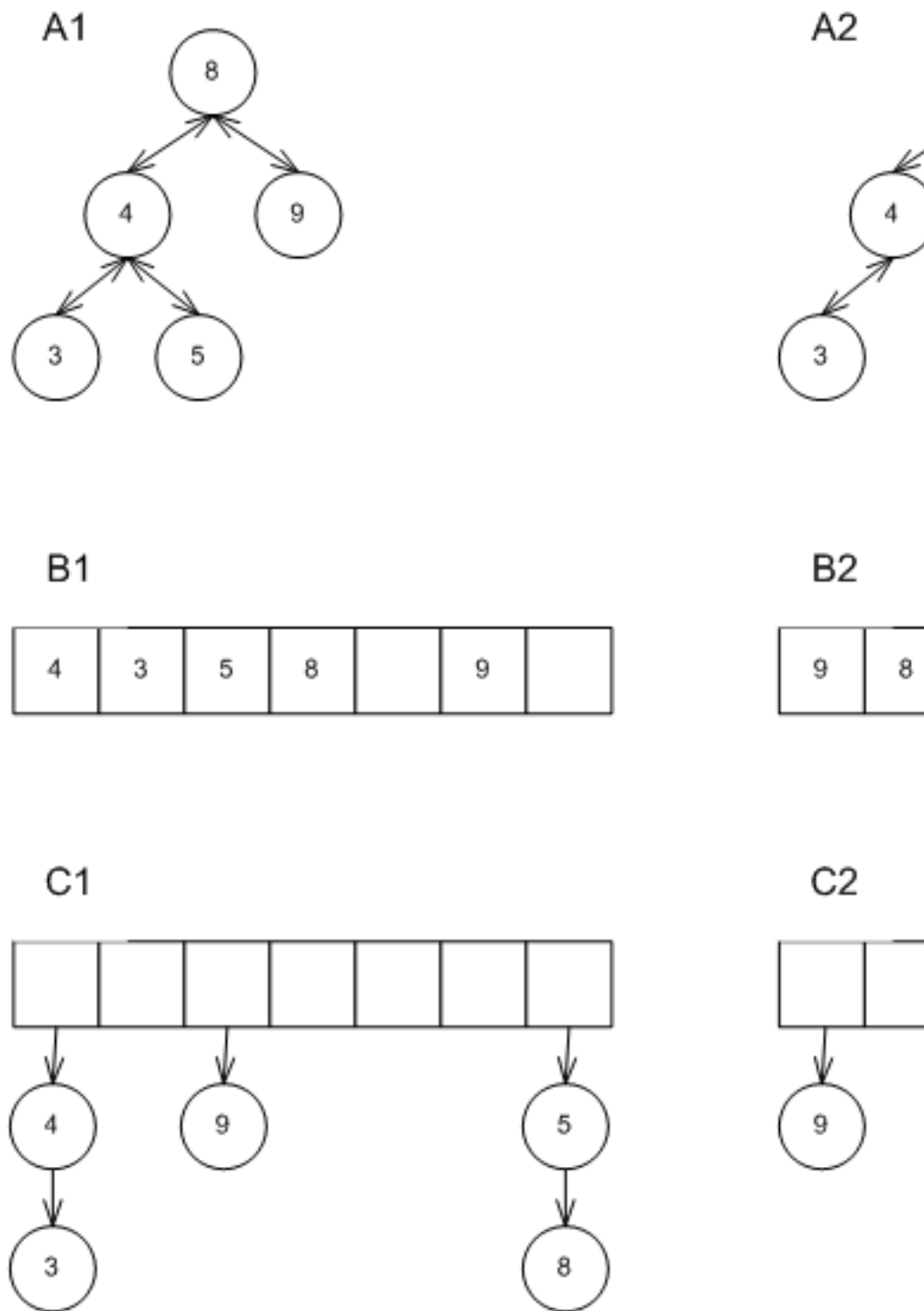

Figure 22.5: Effect of erase in different underlying data structures

1. Erasing 5 from A1 yields A2. Clearly, an iterator to 3 can be de-referenced and incremented. The sequence of iterators changed, but in a way that is well-defined by the interface.

2. Erasing 5 from B1 yields B2. Clearly, an iterator to 3 is not valid at all - it cannot be de-referenced or incremented; the order of iterators changed in a way that is (practically) determined by the implementation and not by the interface.
3. Erasing 5 from C1 yields C2. Here the situation is more complicated. On the one hand, there is no problem in de-referencing `it`. On the other hand, the order of iterators changed in a way that is (practically) determined by the implementation and not by the interface.

So in the standard library containers, it is not always possible to express whether `it` is valid or not. This is true also for `insert`. Again, the iterator concept seems overloaded.

22.1.2.1.4 Functional

The design of the functional overlay to the underlying data structures differs slightly from some of the conventions used in the C++ standard. A strict public interface of methods that comprise only operations which depend on the class's internal structure; other operations are best designed as external functions. (See [84]). With this rubric, the standard associative containers lack some useful methods, and provide other methods which would be better removed.

22.1.2.1.4.1 `erase`

1. Order-preserving standard associative containers provide the method

```
iterator
erase(iterator it)
```

which takes an iterator, erases the corresponding element, and returns an iterator to the following element. Also standard hash-based associative containers provide this method. This seemingly increases genericity between associative containers, since it is possible to use

```
typename C::iterator it = c.begin();
typename C::iterator e_it = c.end();

while(it != e_it)
  it = pred(*it)? c.erase(it) : ++it;
```

in order to erase from a container object `c` all element which match a predicate `pred`. However, in a different sense this actually decreases genericity: an integral implication of this method is that tree-based associative containers' memory use is linear in the total number of elements they store, while hash-based containers' memory use is unbounded in the total number of elements they store. Assume a hash-based container is allowed to decrease its size when an element is erased. Then the elements might be reshaped, which means that there is no "next" element - it is simply undefined. Consequently, it is possible to infer from the fact that the standard library's hash-based containers provide this method that they cannot downsize when elements are erased. As a consequence, different code is needed to manipulate different containers, assuming that memory should be conserved. Therefore, this library's non-order preserving associative containers omit this method.

2. All associative containers include a conditional-erase method

```
template<
class Pred>
size_type
erase_if
(Pred pred)
```

which erases all elements matching a predicate. This is probably the only way to ensure linear-time multiple-item erase which can actually downsize a container.

3. The standard associative containers provide methods for multiple-item erase of the form

```
size_type
erase(It b, It e)
```

erasing a range of elements given by a pair of iterators. For tree-based or trie-based containers, this can be implemented more efficiently as a (small) sequence of split and join operations. For other, unordered, containers, this method isn't much better than an external loop. Moreover, if `c` is a hash-based container, then

```
c.erase(c.find(2), c.find(5))
```

is almost certain to do something different than erasing all elements whose keys are between 2 and 5, and is likely to produce other undefined behavior.

22.1.2.1.4.2 `split` and `join`

It is well-known that tree-based and trie-based container objects can be efficiently split or joined (See [66]). Externally splitting or joining trees is super-linear, and, furthermore, can throw exceptions. Split and join methods, consequently, seem good choices for tree-based container methods, especially, since as noted just before, they are efficient replacements for erasing sub-sequences.

22.1.2.1.4.3 `insert`

The standard associative containers provide methods of the form

```
template<class It>
size_type
insert(It b, It e);
```

for inserting a range of elements given by a pair of iterators. At best, this can be implemented as an external loop, or, even more efficiently, as a join operation (for the case of tree-based or trie-based containers). Moreover, these methods seem similar to constructors taking a range given by a pair of iterators; the constructors, however, are transactional, whereas the insert methods are not; this is possibly confusing.

22.1.2.1.4.4 `operator==` and `operator<=`

Associative containers are parametrized by policies allowing to test key equivalence: a hash-based container can do this through its equivalence functor, and a tree-based container can do this through its comparison functor. In addition, some standard associative containers have global function operators, like `operator==` and `operator<=`, that allow comparing entire associative containers.

In our opinion, these functions are better left out. To begin with, they do not significantly improve over an external loop. More importantly, however, they are possibly misleading - `operator==`, for example, usually checks for equivalence, or interchangeability, but the associative container cannot check for values' equivalence, only keys' equivalence; also, are two containers considered equivalent if they store the same values in different order? this is an arbitrary decision.

22.1.2.2 Priority Queues

22.1.2.2.1 Policy Choices

Priority queues are containers that allow efficiently inserting values and accessing the maximal value (in the sense of the container's comparison functor). Their interface supports `push` and `pop`. The standard container `std::priorityqueue` indeed support these methods, but little else. For algorithmic and software-engineering purposes, other methods are needed:

1. Many graph algorithms (see [66]) require increasing a value in a priority queue (again, in the sense of the container's comparison functor), or joining two priority-queue objects.
2. The return type of `priority_queue`'s `push` method is a point-type iterator, which can be used for modifying or erasing arbitrary values. For example:

```
priority_queue<int> p;
priority_queue<int>::point_iterator it = p.push(3);
p.modify(it, 4);
```

These types of cross-referencing operations are necessary for making priority queues useful for different applications, especially graph applications.

3. It is sometimes necessary to erase an arbitrary value in a priority queue. For example, consider the `select` function for monitoring file descriptors:

```
int
select(int nfd, fd_set *readfds, fd_set *writefds, fd_set *errorfds,
struct timeval *timeout);
```

then, as the `select` documentation states:

“The `nfd` argument specifies the range of file descriptors to be tested. The `select()` function tests file descriptors in the range of 0 to `nfd-1`.”

It stands to reason, therefore, that we might wish to maintain a minimal value for `nfd`, and priority queues immediately come to mind. Note, though, that when a socket is closed, the minimal file description might change; in the absence of an efficient means to erase an arbitrary value from a priority queue, we might as well avoid its use altogether.

The standard containers typically support iterators. It is somewhat unusual for `std::priority_queue` to omit them (See [83]). One might ask why do priority queues need to support iterators, since they are self-organizing containers with a different purpose than abstracting sequences. There are several reasons:

- (a) Iterators (even in self-organizing containers) are useful for many purposes: cross-referencing containers, serialization, and debugging code that uses these containers.
- (b) The standard library’s hash-based containers support iterators, even though they too are self-organizing containers with a different purpose than abstracting sequences.
- (c) In standard-library-like containers, it is natural to specify the interface of operations for modifying a value or erasing a value (discussed previously) in terms of iterators. It should be noted that the standard containers also use iterators for accessing and manipulating a specific value. In hash-based containers, one checks the existence of a key by comparing the iterator returned by `find` to the iterator returned by `end`, and not by comparing a pointer returned by `find` to `NULL`.

22.1.2.2.2 Underlying Data Structures

There are three main implementations of priority queues: the first employs a binary heap, typically one which uses a sequence; the second uses a tree (or forest of trees), which is typically less structured than an associative container’s tree; the third simply uses an associative container. These are shown in the figure below with labels A1 and A2, B, and C.

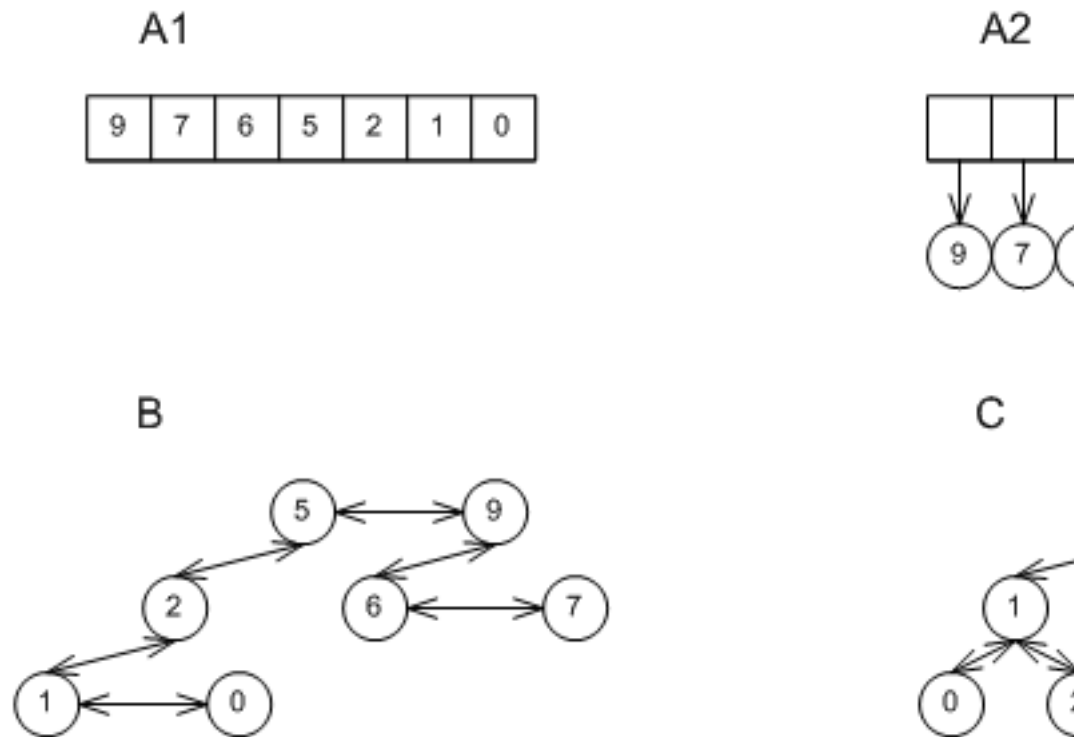

Figure 22.6: Underlying Priority Queue Data Structures

No single implementation can completely replace any of the others. Some have better `push` and `pop` amortized performance, some have better bounded (worst case) response time than others, some optimize a single method at the expense of others, etc. In general the "best" implementation is dictated by the specific problem.

As with associative containers, the more implementations co-exist, the more necessary a traits mechanism is for handling generic containers safely and efficiently. This is especially important for priority queues, since the invalidation guarantees of one of the most useful data structures - binary heaps - is markedly different than those of most of the others.

22.1.2.2.3 Binary Heaps

Binary heaps are one of the most useful underlying data structures for priority queues. They are very efficient in terms of memory (since they don't require per-value structure metadata), and have the best amortized `push` and `pop` performance for primitive types like `int`.

The standard library's `priority_queue` implements this data structure as an adapter over a sequence, typically `std::vector` or `std::deque`, which correspond to labels A1 and A2 respectively in the graphic above.

This is indeed an elegant example of the adapter concept and the algorithm/container/iterator decomposition. (See [89]). There are several reasons why a binary-heap priority queue may be better implemented as a container instead of a sequence adapter:

1. `std::priority_queue` cannot erase values from its adapted sequence (irrespective of the sequence type). This means that the memory use of an `std::priority_queue` object is always proportional to the maximal number of values it ever contained, and not to the number of values that it currently contains. (See `performance/priority_queue_text_pop_mem_usage.cc`.) This implementation of binary heaps acts very differently than other underlying data structures (See also pairing heaps).

2. Some combinations of adapted sequences and value types are very inefficient or just don't make sense. If one uses `std::priority_queue<std::vector<std::string>>`, for example, then not only will each operation perform a logarithmic number of `std::string` assignments, but, furthermore, any operation (including `pop`) can render the container useless due to exceptions. Conversely, if one uses `std::priority_queue<std::deque<int>>`, then each operation uses incurs a logarithmic number of indirect accesses (through pointers) unnecessarily. It might be better to let the container make a conservative deduction whether to use the structure in the graphic above, labels A1 or A2.
3. There does not seem to be a systematic way to determine what exactly can be done with the priority queue.
 - (a) If `p` is a priority queue adapting an `std::vector`, then it is possible to iterate over all values by using `&p.top()` and `&p.top() + p.size()`, but this will not work if `p` is adapting an `std::deque`; in any case, one cannot use `p.begin()` and `p.end()`. If a different sequence is adapted, it is even more difficult to determine what can be done.
 - (b) If `p` is a priority queue adapting an `std::deque`, then the reference return by

```
p.top()
```

 will remain valid until it is popped, but if `p` adapts an `std::vector`, the next push will invalidate it. If a different sequence is adapted, it is even more difficult to determine what can be done.
4. Sequence-based binary heaps can still implement linear-time `erase` and `modify` operations. This means that if one needs to erase a small (say logarithmic) number of values, then one might still choose this underlying data structure. Using `std::priority_queue`, however, this will generally change the order of growth of the entire sequence of operations.

22.2 Using

22.2.1 Prerequisites

The library contains only header files, and does not require any other libraries except the standard C++ library. All classes are defined in namespace `__gnu_pbds`. The library internally uses macros beginning with `PB_DS`, but `#undefs` anything it `#defines` (except for header guards). Compiling the library in an environment where macros beginning in `PB_DS` are defined, may yield unpredictable results in compilation, execution, or both.

Further dependencies are necessary to create the visual output for the performance tests. To create these graphs, an additional package is needed: **pychart**.

22.2.2 Organization

The various data structures are organized as follows.

- Branch-Based
 - `basic_branch` is an abstract base class for branched-based associative-containers
 - `tree` is a concrete base class for tree-based associative-containers
 - `trie` is a concrete base class trie-based associative-containers
- Hash-Based
 - `basic_hash_table` is an abstract base class for hash-based associative-containers
 - `cc_hash_table` is a concrete collision-chaining hash-based associative-containers
 - `gp_hash_table` is a concrete (general) probing hash-based associative-containers
- List-Based

- `list_update` list-based update-policy associative container
- Heap-Based
 - `priority_queue` A priority queue.

The hierarchy is composed naturally so that commonality is captured by base classes. Thus `operator[]` is defined at the base of any hierarchy, since all derived containers support it. Conversely `split` is defined in `basic_branch`, since only tree-like containers support it.

In addition, there are the following diagnostics classes, used to report errors specific to this library's data structures.

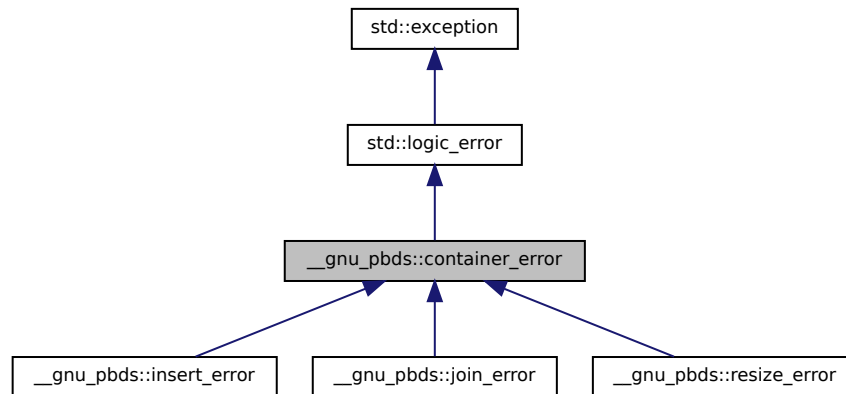

Figure 22.7: Exception Hierarchy

22.2.3 Tutorial

22.2.3.1 Basic Use

For the most part, the policy-based containers containers in namespace `__gnu_pbds` have the same interface as the equivalent containers in the standard C++ library, except for the names used for the container classes themselves. For example, this shows basic operations on a collision-chaining hash-based container:

```

#include <ext/pb_ds/assoc_container.h>

int main()
{
  __gnu_pbds::cc_hash_table<int, char> c;
  c[2] = 'b';
  assert(c.find(1) == c.end());
};

```

The container is called `__gnu_pbds::cc_hash_table` instead of `std::unordered_map`, since “unordered map” does not necessarily mean a hash-based map as implied by the C++ library (C++11 or TR1). For example, list-based associative containers, which are very useful for the construction of “multimaps,” are also unordered.

This snippet shows a red-black tree based container:

```

#include <ext/pb_ds/assoc_container.h>

int main()
{
  __gnu_pbds::tree<int, char> c;
  c[2] = 'b';
  assert(c.find(2) != c.end());
};

```

The container is called `tree` instead of `map` since the underlying data structures are being named with specificity.

The member function naming convention is to strive to be the same as the equivalent member functions in other C++ standard library containers. The familiar methods are unchanged: `begin`, `end`, `size`, `empty`, and `clear`.

This isn't to say that things are exactly as one would expect, given the container requirements and interfaces in the C++ standard. The names of containers' policies and policy accessors are different than the usual. For example, if `hash_type` is some type of hash-based container, then

```
hash_type::hash_fn
```

gives the type of its hash functor, and if `obj` is some hash-based container object, then

```
obj.get_hash_fn()
```

will return a reference to its hash-functor object.

Similarly, if `tree_type` is some type of tree-based container, then

```
tree_type::cmp_fn
```

gives the type of its comparison functor, and if `obj` is some tree-based container object, then

```
obj.get_cmp_fn()
```

will return a reference to its comparison-functor object.

It would be nice to give names consistent with those in the existing C++ standard (inclusive of TR1). Unfortunately, these standard containers don't consistently name types and methods. For example, `std::tr1::unordered_map` uses `hasher` for the hash functor, but `std::map` uses `key_compare` for the comparison functor. Also, we could not find an accessor for `std::tr1::unordered_map`'s hash functor, but `std::map` uses `compare` for accessing the comparison functor.

Instead, `__gnu_pbds` attempts to be internally consistent, and uses standard-derived terminology if possible.

Another source of difference is in scope: `__gnu_pbds` contains more types of associative containers than the standard C++ library, and more opportunities to configure these new containers, since different types of associative containers are useful in different settings.

Namespace `__gnu_pbds` contains different classes for hash-based containers, tree-based containers, trie-based containers, and list-based containers.

Since associative containers share parts of their interface, they are organized as a class hierarchy.

Each type or method is defined in the most-common ancestor in which it makes sense.

For example, all associative containers support iteration expressed in the following form:

```
const_iterator
begin() const;

iterator
begin();

const_iterator
end() const;

iterator
end();
```

But not all containers contain or use hash functors. Yet, both collision-chaining and (general) probing hash-based associative containers have a hash functor, so `basic_hash_table` contains the interface:

```
const hash_fn&
get_hash_fn() const;

hash_fn&
get_hash_fn();
```

so all hash-based associative containers inherit the same hash-functor accessor methods.

22.2.3.2 Configuring via Template Parameters

In general, each of this library's containers is parametrized by more policies than those of the standard library. For example, the standard hash-based container is parametrized as follows:

```
template<typename Key, typename Mapped, typename Hash,
typename Pred, typename Allocator, bool Cache_Hashe_Code>
class unordered_map;
```

and so can be configured by key type, mapped type, a functor that translates keys to unsigned integral types, an equivalence predicate, an allocator, and an indicator whether to store hash values with each entry. this library's collision-chaining hash-based container is parametrized as

```
template<typename Key, typename Mapped, typename Hash_Fn,
typename Eq_Fn, typename Comb_Hash_Fn,
typename Resize_Policy, bool Store_Hash
typename Allocator>
class cc_hash_table;
```

and so can be configured by the first four types of `std::tr1::unordered_map`, then a policy for translating the key-hash result into a position within the table, then a policy by which the table resizes, an indicator whether to store hash values with each entry, and an allocator (which is typically the last template parameter in standard containers).

Nearly all policy parameters have default values, so this need not be considered for casual use. It is important to note, however, that hash-based containers' policies can dramatically alter their performance in different settings, and that tree-based containers' policies can make them useful for other purposes than just look-up.

As opposed to associative containers, priority queues have relatively few configuration options. The priority queue is parametrized as follows:

```
template<typename Value_Type, typename Cmp_Fn, typename Tag,
typename Allocator>
class priority_queue;
```

The `Value_Type`, `Cmp_Fn`, and `Allocator` parameters are the container's value type, comparison-functor type, and allocator type, respectively; these are very similar to the standard's priority queue. The `Tag` parameter is different: there are a number of pre-defined tag types corresponding to binary heaps, binomial heaps, etc., and `Tag` should be instantiated by one of them.

Note that as opposed to the `std::priority_queue`, `__gnu_pbds::priority_queue` is not a sequence-adapter; it is a regular container.

22.2.3.3 Querying Container Attributes

A containers underlying data structure affect their performance; Unfortunately, they can also affect their interface. When manipulating generically associative containers, it is often useful to be able to statically determine what they can support and what the cannot.

Happily, the standard provides a good solution to a similar problem - that of the different behavior of iterators. If `It` is an iterator, then

```
typename std::iterator_traits<It>::iterator_category
```

is one of a small number of pre-defined tag classes, and

```
typename std::iterator_traits<It>::value_type
```

is the value type to which the iterator "points".

Similarly, in this library, if `C` is a container, then `container_traits` is a trait class that stores information about the kind of container that is implemented.

```
typename container_traits<C>::container_category
```

is one of a small number of predefined tag structures that uniquely identifies the type of underlying data structure.

In most cases, however, the exact underlying data structure is not really important, but what is important is one of its other attributes: whether it guarantees storing elements by key order, for example. For this one can use

```
typename container_traits<C>::order_preserving
```

Also,

```
typename container_traits<C>::invalidation_guarantee
```

is the container's invalidation guarantee. Invalidation guarantees are especially important regarding priority queues, since in this library's design, iterators are practically the only way to manipulate them.

22.2.3.4 Point and Range Iteration

This library differentiates between two types of methods and iterators: point-type, and range-type. For example, `find` and `insert` are point-type methods, since they each deal with a specific element; their returned iterators are point-type iterators. `begin` and `end` are range-type methods, since they are not used to find a specific element, but rather to go over all elements in a container object; their returned iterators are range-type iterators.

Most containers store elements in an order that is determined by their interface. Correspondingly, it is fine that their point-type iterators are synonymous with their range-type iterators. For example, in the following snippet

```
std::for_each(c.find(1), c.find(5), foo);
```

two point-type iterators (returned by `find`) are used for a range-type purpose - going over all elements whose key is between 1 and 5.

Conversely, the above snippet makes no sense for self-organizing containers - ones that order (and reorder) their elements by implementation. It would be nice to have a uniform iterator system that would allow the above snippet to compile only if it made sense.

This could trivially be done by specializing `std::for_each` for the case of iterators returned by `std::tr1::unordered_map`, but this would only solve the problem for one algorithm and one container. Fundamentally, the problem is that one can loop using a self-organizing container's point-type iterators.

This library's containers define two families of iterators: `point_const_iterator` and `point_iterator` are the iterator types returned by point-type methods; `const_iterator` and `iterator` are the iterator types returned by range-type methods.

```
class <- some container ->
{
public:
...

typedef <- something -> const_iterator;

typedef <- something -> iterator;

typedef <- something -> point_const_iterator;

typedef <- something -> point_iterator;

...

public:
...

const_iterator begin () const;

iterator begin();
```

```
point_const_iterator find(...) const;

point_iterator find(...);
};
```

For containers whose interface defines sequence order, it is very simple: point-type and range-type iterators are exactly the same, which means that the above snippet will compile if it is used for an order-preserving associative container.

For self-organizing containers, however, (hash-based containers as a special example), the preceding snippet will not compile, because their point-type iterators do not support `operator++`.

In any case, both for order-preserving and self-organizing containers, the following snippet will compile:

```
typename Cntnr::point_iterator it = c.find(2);
```

because a range-type iterator can always be converted to a point-type iterator.

Distinguishing between iterator types also raises the point that a container's iterators might have different invalidation rules concerning their de-referencing abilities and movement abilities. This now corresponds exactly to the question of whether point-type and range-type iterators are valid. As explained above, `container_traits` allows querying a container for its data structure attributes. The iterator-invalidation guarantees are certainly a property of the underlying data structure, and so

```
container_traits<C>::invalidation_guarantee
```

gives one of three pre-determined types that answer this query.

22.2.4 Examples

Additional code examples are provided in the source distribution, as part of the regression and performance test suite.

22.2.4.1 Intermediate Use

- Basic use of maps: `basic_map.cc`
- Basic use of sets: `basic_set.cc`
- Conditionally erasing values from an associative container object: `erase_if.cc`
- Basic use of multimaps: `basic_multimap.cc`
- Basic use of multisets: `basic_multiset.cc`
- Basic use of priority queues: `basic_priority_queue.cc`
- Splitting and joining priority queues: `priority_queue_split_join.cc`
- Conditionally erasing values from a priority queue: `priority_queue_erase_if.cc`

22.2.4.2 Querying with `container_traits`

- Using `container_traits` to query about underlying data structure behavior: `assoc_container_traits.cc`
- A non-compiling example showing wrong use of finding keys in hash-based containers: `hash_find_neg.cc`
- Using `container_traits` to query about underlying data structure behavior: `priority_queue_container_traits.cc`

22.2.4.3 By Container Method

22.2.4.3.1 Hash-Based

22.2.4.3.1.1 size Related

- Setting the initial size of a hash-based container object: `hash_initial_size.cc`
- A non-compiling example showing how not to resize a hash-based container object: `hash_resize_neg.cc`
- Resizing the size of a hash-based container object: `hash_resize.cc`
- Showing an illegal resize of a hash-based container object: `hash_illegal_resize.cc`
- Changing the load factors of a hash-based container object: `hash_load_set_change.cc`

22.2.4.3.1.2 Hashing Function Related

- Using a modulo range-hashing function for the case of an unknown skewed key distribution: `hash_mod.cc`
- Writing a range-hashing functor for the case of a known skewed key distribution: `shift_mask.cc`
- Storing the hash value along with each key: `store_hash.cc`
- Writing a ranged-hash functor: `ranged_hash.cc`

22.2.4.3.2 Branch-Based

22.2.4.3.2.1 split or join Related

- Joining two tree-based container objects: `tree_join.cc`
- Splitting a PATRICIA trie container object: `trie_split.cc`
- Order statistics while joining two tree-based container objects: `tree_order_statistics_join.cc`

22.2.4.3.2.2 Node Invariants

- Using trees for order statistics: `tree_order_statistics.cc`
- Augmenting trees to support operations on line intervals: `tree_intervals.cc`

22.2.4.3.2.3 trie

- Using a PATRICIA trie for DNA strings: `trie_dna.cc`
- Using a PATRICIA trie for finding all entries whose key matches a given prefix: `trie_prefix_search.cc`

22.2.4.3.3 Priority Queues

- Cross referencing an associative container and a priority queue: `priority_queue_xref.cc`
- Cross referencing a vector and a priority queue using a very simple version of Dijkstra's shortest path algorithm: `priority_queue_dijkstra.cc`

22.3 Design

22.3.1 Concepts

22.3.1.1 Null Policy Classes

Associative containers are typically parametrized by various policies. For example, a hash-based associative container is parametrized by a hash-functor, transforming each key into a non-negative numerical type. Each such value is then further mapped into a position within the table. The mapping of a key into a position within the table is therefore a two-step process.

In some cases, instantiations are redundant. For example, when the keys are integers, it is possible to use a redundant hash policy, which transforms each key into its value.

In some other cases, these policies are irrelevant. For example, a hash-based associative container might transform keys into positions within a table by a different method than the two-step method described above. In such a case, the hash functor is simply irrelevant.

When a policy is either redundant or irrelevant, it can be replaced by `null_type`.

For example, a `set` is an associative container with one of its template parameters (the one for the mapped type) replaced with `null_type`. Other places simplifications are made possible with this technique include node updates in tree and trie data structures, and hash and probe functions for hash data structures.

22.3.1.2 Map and Set Semantics

22.3.1.2.1 Distinguishing Between Maps and Sets

Anyone familiar with the standard knows that there are four kinds of associative containers: maps, sets, multimaps, and multisets. The map datatype associates each key to some data.

Sets are associative containers that simply store keys - they do not map them to anything. In the standard, each map class has a corresponding set class. E.g., `std::map<int, char>` maps each `int` to a `char`, but `std::set<int, char>` simply stores `ints`. In this library, however, there are no distinct classes for maps and sets. Instead, an associative container's Mapped template parameter is a policy: if it is instantiated by `null_type`, then it is a "set"; otherwise, it is a "map". E.g.,

```
cc_hash_table<int, char>
```

is a "map" mapping each `int` value to a `char`, but

```
cc_hash_table<int, null_type>
```

is a type that uniquely stores `int` values.

Once the Mapped template parameter is instantiated by `null_type`, then the "set" acts very similarly to the standard's sets - it does not map each key to a distinct `null_type` object. Also, the container's `value_type` is essentially its `key_type` - just as with the standard's sets.

The standard's multimaps and multisets allow, respectively, non-uniquely mapping keys and non-uniquely storing keys. As discussed, the reasons why this might be necessary are 1) that a key might be decomposed into a primary key and a secondary key, 2) that a key might appear more than once, or 3) any arbitrary combination of 1)s and 2)s. Correspondingly, one should use 1) "maps" mapping primary keys to secondary keys, 2) "maps" mapping keys to size types, or 3) any arbitrary combination of 1)s and 2)s. Thus, for example, an `std::multiset<int>` might be used to store multiple instances of integers, but using this library's containers, one might use

```
tree<int, size_t>
```

i.e., a map of `ints` to `size_ts`.

These "multimaps" and "multisets" might be confusing to anyone familiar with the standard's `std::multimap` and `std::multiset`, because there is no clear correspondence between the two. For example, in some cases where one uses `std::multiset` in the standard, one might use in this library a "multimap" of "multisets" - i.e., a container that maps primary keys each to an associative container that maps each secondary key to the number of times it occurs.

When one uses a "multimap," one should choose with care the type of container used for secondary keys.

22.3.1.2.2 Alternatives to `std::multiset` and `std::multimap`

Brace oneself: this library does not contain containers like `std::multimap` or `std::multiset`. Instead, these data structures can be synthesized via manipulation of the `Mapped` template parameter.

One maps the unique part of a key - the primary key, into an associative-container of the (originally) non-unique parts of the key - the secondary key. A primary associative-container is an associative container of primary keys; a secondary associative-container is an associative container of secondary keys.

Stepping back a bit, and starting in from the beginning.

Maps (or sets) allow mapping (or storing) unique-key values. The standard library also supplies associative containers which map (or store) multiple values with equivalent keys: `std::multimap`, `std::multiset`, `std::tr1::unordered_multimap`, and `unordered_multiset`. We first discuss how these might be used, then why we think it is best to avoid them.

Suppose one builds a simple bank-account application that records for each client (identified by an `std::string`) and account-id (marked by an unsigned long) - the balance in the account (described by a float). Suppose further that ordering this information is not useful, so a hash-based container is preferable to a tree based container. Then one can use

```
std::tr1::unordered_map<std::pair<std::string, unsigned long>, float, ...>
```

which hashes every combination of client and account-id. This might work well, except for the fact that it is now impossible to efficiently list all of the accounts of a specific client (this would practically require iterating over all entries). Instead, one can use

```
std::tr1::unordered_multimap<std::pair<std::string, unsigned long>, float, ...>
```

which hashes every client, and decides equivalence based on client only. This will ensure that all accounts belonging to a specific user are stored consecutively.

Also, suppose one wants an integers' priority queue (a container that supports `push`, `pop`, and `top` operations, the last of which returns the largest int) that also supports operations such as `find` and `lower_bound`. A reasonable solution is to build an adapter over `std::set<int>`. In this adapter, `push` will just call the tree-based associative container's `insert` method; `pop` will call its `end` method, and use it to return the preceding element (which must be the largest). Then this might work well, except that the container object cannot hold multiple instances of the same integer (`push(4)`, will be a no-op if 4 is already in the container object). If multiple keys are necessary, then one might build the adapter over an `std::multiset<int>`.

The standard library's non-unique-mapping containers are useful when (1) a key can be decomposed in to a primary key and a secondary key, (2) a key is needed multiple times, or (3) any combination of (1) and (2).

The graphic below shows how the standard library's container design works internally; in this figure nodes shaded equally represent equivalent-key values. Equivalent keys are stored consecutively using the properties of the underlying data structure: binary search trees (label A) store equivalent-key values consecutively (in the sense of an in-order walk) naturally; collision-chaining hash tables (label B) store equivalent-key values in the same bucket, the bucket can be arranged so that equivalent-key values are consecutive.

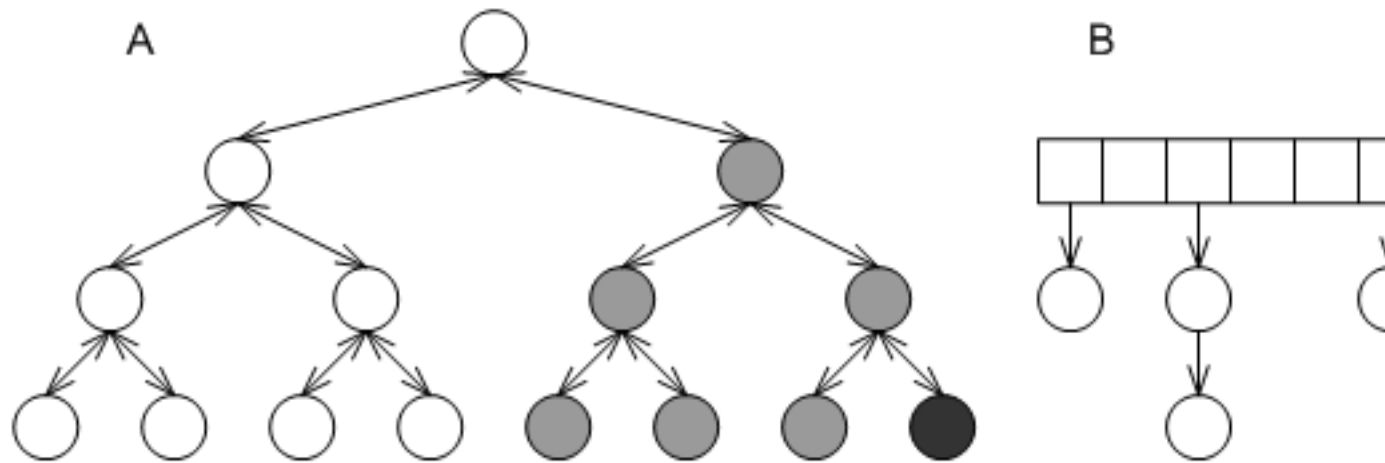

Figure 22.8: Non-unique Mapping Standard Containers

Put differently, the standards' non-unique mapping associative-containers are associative containers that map primary keys to linked lists that are embedded into the container. The graphic below shows again the two containers from the first graphic above, this time with the embedded linked lists of the grayed nodes marked explicitly.

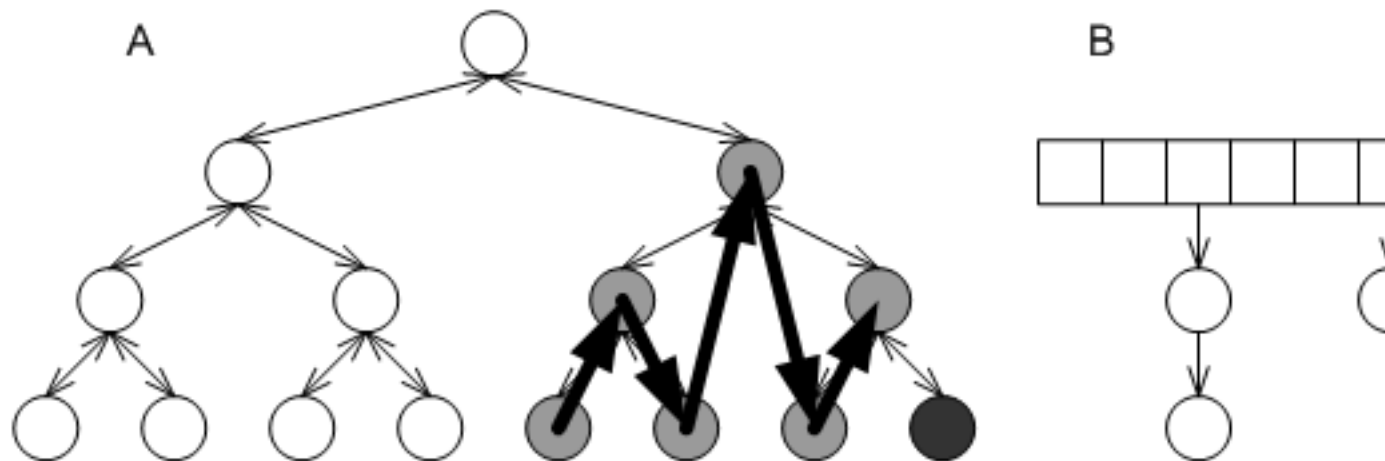

Figure 22.9: Effect of embedded lists in `std::multimap`

These embedded linked lists have several disadvantages.

1. The underlying data structure embeds the linked lists according to its own consideration, which means that the search path for a value might include several different equivalent-key values. For example, the search path for the the black node in either of the first graphic, labels A or B, includes more than a single gray node.
2. The links of the linked lists are the underlying data structures' nodes, which typically are quite structured. In the case of tree-based containers (the graphic above, label B), each "link" is actually a node with three pointers (one to a parent and two to children), and a relatively-complicated iteration algorithm. The linked lists, therefore, can take up quite a lot of memory, and iterating over all values equal to a given key (through the return value of the standard library's `equal_range`) can be expensive.
3. The primary key is stored multiply; this uses more memory.
4. Finally, the interface of this design excludes several useful underlying data structures. Of all the unordered self-organizing data structures, practically only collision-chaining hash tables can (efficiently) guarantee that equivalent-key values are stored consecutively.

The above reasons hold even when the ratio of secondary keys to primary keys (or average number of identical keys) is small, but when it is large, there are more severe problems:

1. The underlying data structures order the links inside each embedded linked-lists according to their internal considerations, which effectively means that each of the links is unordered. Irrespective of the underlying data structure, searching for a specific value can degrade to linear complexity.
2. Similarly to the above point, it is impossible to apply to the secondary keys considerations that apply to primary keys. For example, it is not possible to maintain secondary keys by sorted order.
3. While the interface "understands" that all equivalent-key values constitute a distinct list (through `equal_range`), the underlying data structure typically does not. This means that operations such as erasing from a tree-based container all values whose keys are equivalent to a a given key can be super-linear in the size of the tree; this is also true also for several other operations that target a specific list.

In this library, all associative containers map (or store) unique-key values. One can (1) map primary keys to secondary associative-containers (containers of secondary keys) or non-associative containers (2) map identical keys to a size-type representing the number of times they occur, or (3) any combination of (1) and (2). Instead of allowing multiple equivalent-key values, this library supplies associative containers based on underlying data structures that are suitable as secondary associative-containers.

In the figure below, labels A and B show the equivalent underlying data structures in this library, as mapped to the first graphic above. Labels A and B, respectively. Each shaded box represents some size-type or secondary associative-container.

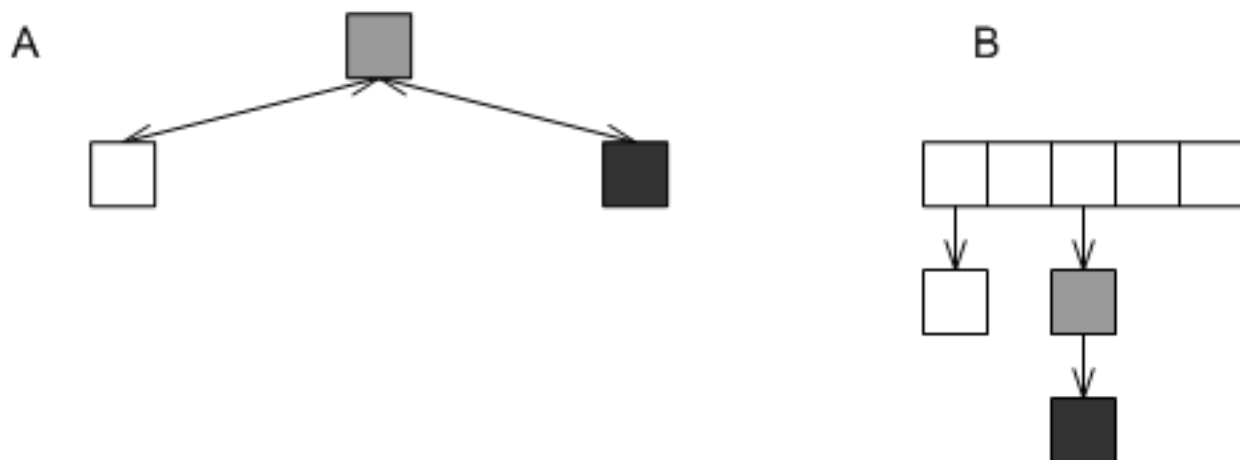

Figure 22.10: Non-unique Mapping Containers

In the first example above, then, one would use an associative container mapping each user to an associative container which maps each application id to a start time (see `example/basic_multimap.cc`); in the second example, one would use an associative container mapping each `int` to some size-type indicating the number of times it logically occurs (see `example/basic_multiset.cc`).

See the discussion in list-based container types for containers especially suited as secondary associative-containers.

22.3.1.3 Iterator Semantics

22.3.1.3.1 Point and Range Iterators

Iterator concepts are bifurcated in this design, and are comprised of point-type and range-type iteration.

A point-type iterator is an iterator that refers to a specific element as returned through an associative-container's `find` method.

A range-type iterator is an iterator that is used to go over a sequence of elements, as returned by a container's `find` method.

A point-type method is a method that returns a point-type iterator; a range-type method is a method that returns a range-type iterator.

For most containers, these types are synonymous; for self-organizing containers, such as hash-based containers or priority queues, these are inherently different (in any implementation, including that of C++ standard library components), but in this design, it is made explicit. They are distinct types.

22.3.1.3.2 Distinguishing Point and Range Iterators

When using this library, is necessary to differentiate between two types of methods and iterators: point-type methods and iterators, and range-type methods and iterators. Each associative container's interface includes the methods:

```
point_const_iterator
find(const_key_reference r_key) const;

point_iterator
find(const_key_reference r_key);

std::pair<point_iterator, bool>
insert(const_reference r_val);
```

The relationship between these iterator types varies between container types. The figure below shows the most general invariant between point-type and range-type iterators: In *A* iterator, can always be converted to `point_iterator`. In *B* shows invariants for order-preserving containers: point-type iterators are synonymous with range-type iterators. Orthogonally, *C* shows invariants for "set" containers: iterators are synonymous with const iterators.

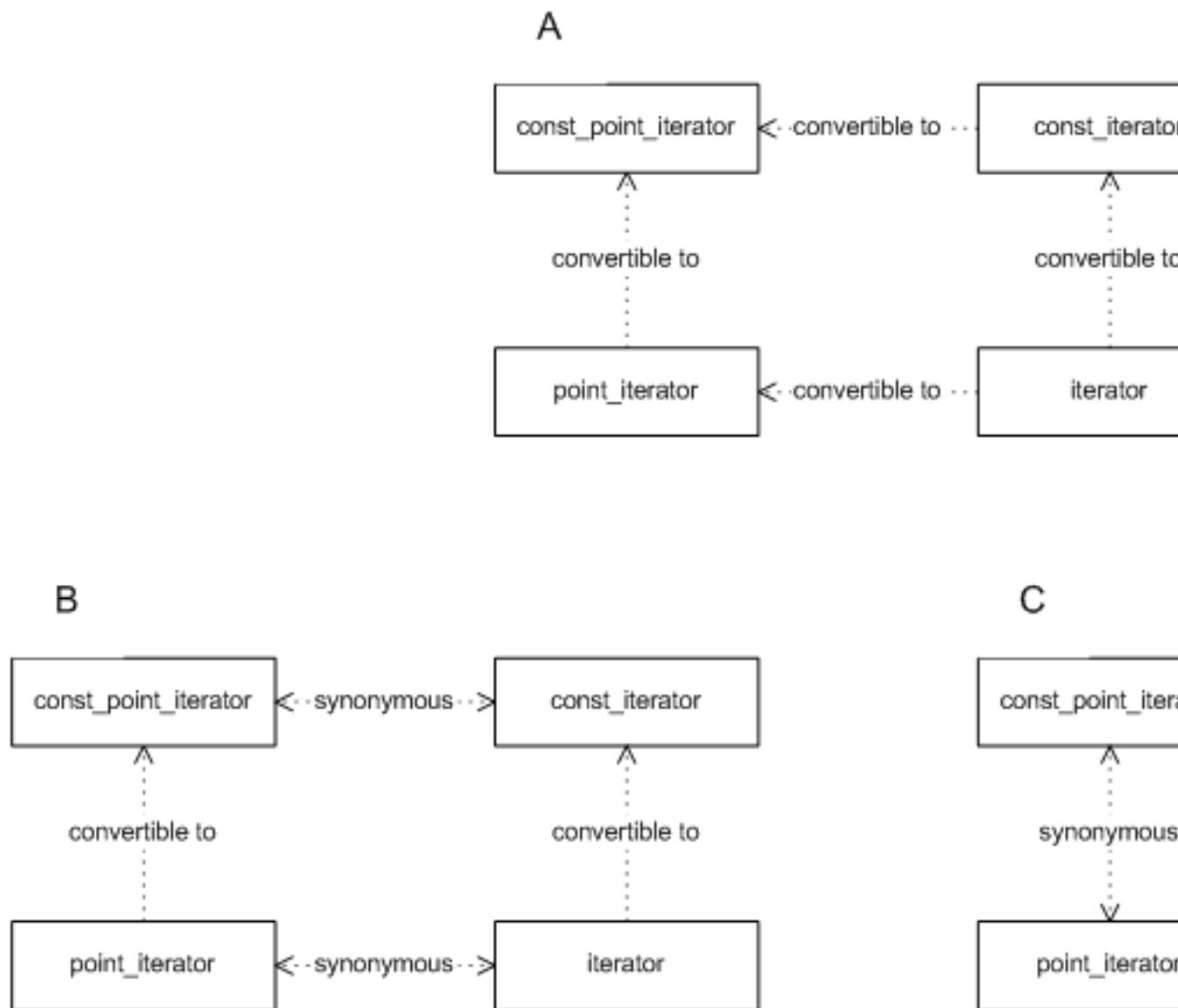

Figure 22.11: Point Iterator Hierarchy

Note that point-type iterators in self-organizing containers (hash-based associative containers) lack movement operators, such as `operator++` - in fact, this is the reason why this library differentiates from the standard C++ library's design on this point.

Typically, one can determine an iterator's movement capabilities using `std::iterator_traits<It>::iterator_category`, which is a `struct` indicating the iterator's movement capabilities. Unfortunately, none of the standard predefined categories reflect a pointer's *not* having any movement capabilities whatsoever. Consequently, `pb_ds` adds a type `trivial_iterator_tag` (whose name is taken from a concept in C++ standardese, which is the category of iterators with no movement capabilities.) All other standard C++ library tags, such as `forward_iterator_tag` retain their common use.

22.3.1.3.3 Invalidation Guarantees

If one manipulates a container object, then iterators previously obtained from it can be invalidated. In some cases a previously-obtained iterator cannot be de-referenced; in other cases, the iterator's next or previous element might have changed unpredictably. This corresponds exactly to the question whether a point-type or range-type iterator (see previous concept) is valid or not. In this design, one can query a container (in compile time) about its invalidation guarantees.

Given three different types of associative containers, a modifying operation (in that example, `erase`) invalidated iterators in three different ways: the iterator of one container remained completely valid - it could be de-referenced and incremented; the iterator of a different container could not even be de-referenced; the iterator of the third container could be de-referenced, but its "next" iterator changed unpredictably.

Distinguishing between `find` and `range` types allows fine-grained invalidation guarantees, because these questions correspond exactly to the question of whether point-type iterators and range-type iterators are valid. The graphic below shows tags corresponding to different types of invalidation guarantees.

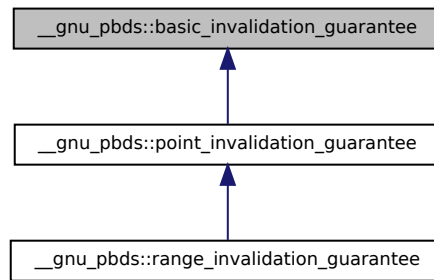

Figure 22.12: Invalidation Guarantee Tags Hierarchy

- `basic_invalidation_guarantee` corresponds to a basic guarantee that a point-type iterator, a found pointer, or a found reference, remains valid as long as the container object is not modified.
- `point_invalidation_guarantee` corresponds to a guarantee that a point-type iterator, a found pointer, or a found reference, remains valid even if the container object is modified.
- `range_invalidation_guarantee` corresponds to a guarantee that a range-type iterator remains valid even if the container object is modified.

To find the invalidation guarantee of a container, one can use

```
typename container_traits<Cntnr>::invalidation_guarantee
```

Note that this hierarchy corresponds to the logic it represents: if a container has range-invalidation guarantees, then it must also have find invalidation guarantees; correspondingly, its invalidation guarantee (in this case `range_invalidation_guarantee`) can be cast to its base class (in this case `point_invalidation_guarantee`). This means that this hierarchy can be used easily using standard metaprogramming techniques, by specializing on the type of `invalidation_guarantee`.

These types of problems were addressed, in a more general setting, in [81] - Item 2. In our opinion, an invalidation-guarantee hierarchy would solve these problems in all container types - not just associative containers.

22.3.1.4 Genericity

The design attempts to address the following problem of data-structure genericity. When writing a function manipulating a generic container object, what is the behavior of the object? Suppose one writes

```
template<typename Cntnr>
void
some_op_sequence(Cntnr &r_container)
{
  ...
}
```

then one needs to address the following questions in the body of `some_op_sequence`:

- Which types and methods does `Cntnr` support? Containers based on hash tables can be queried for the hash-functor type and object; this is meaningless for tree-based containers. Containers based on trees can be split, joined, or can erase iterators and return the following iterator; this cannot be done by hash-based containers.
- What are the exception and invalidation guarantees of `Cntnr`? A container based on a probing hash-table invalidates all iterators when it is modified; this is not the case for containers based on node-based trees. Containers based on a node-based tree can be split or joined without exceptions; this is not the case for containers based on vector-based trees.
- How does the container maintain its elements? Tree-based and Trie-based containers store elements by key order; others, typically, do not. A container based on a splay trees or lists with update policies "cache" "frequently accessed" elements; containers based on most other underlying data structures do not.
- How does one query a container about characteristics and capabilities? What is the relationship between two different data structures, if anything?

The remainder of this section explains these issues in detail.

22.3.1.4.1 Tag

Tags are very useful for manipulating generic types. For example, if `It` is an iterator class, then `typename It::iterator_category` or `typename std::iterator_traits<It>::iterator_category` will yield its category, and `typename std::iterator_traits<It>::value_type` will yield its value type.

This library contains a container tag hierarchy corresponding to the diagram below.

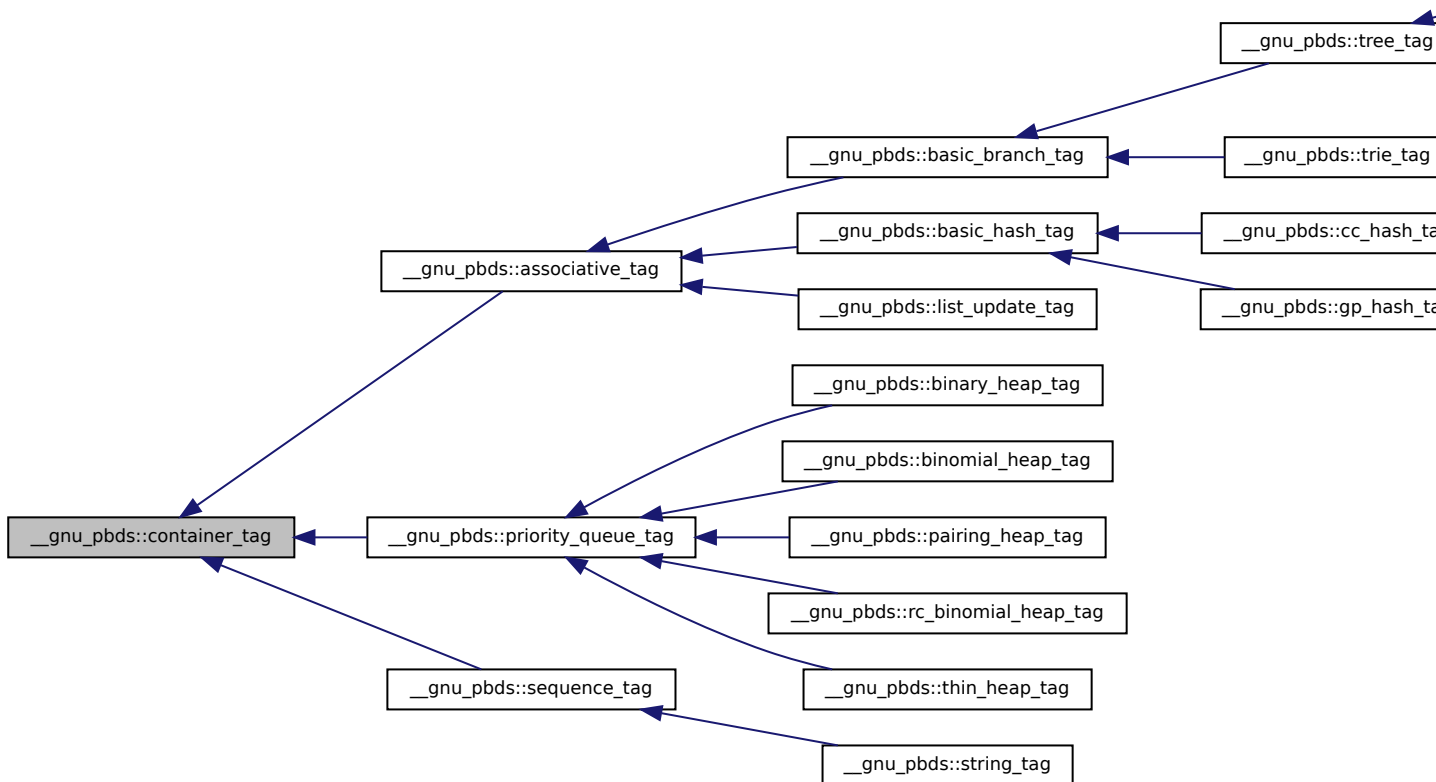

Figure 22.13: Container Tag Hierarchy

Given any container `Cntnr`, the tag of the underlying data structure can be found via `typename Cntnr::container_category`.

22.3.1.4.2 Traits

Additionally, a traits mechanism can be used to query a container type for its attributes. Given any container `Cntnr`, then `<Cntnr>` is a traits class identifying the properties of the container.

To find if a container can throw when a key is erased (which is true for vector-based trees, for example), one can use

```
container_traits<Cntnr>::erase_can_throw
```

Some of the definitions in `container_traits` are dependent on other definitions. If `container_traits<Cntnr>::order_preserving` is true (which is the case for containers based on trees and tries), then the container can be split or joined; in this case, `container_traits<Cntnr>::split_join_can_throw` indicates whether splits or joins can throw exceptions (which is true for vector-based trees); otherwise `container_traits<Cntnr>::split_join_can_throw` will yield a compilation error. (This is somewhat similar to a compile-time version of the COM model).

22.3.2 By Container

22.3.2.1 hash

22.3.2.1.1 Interface

The collision-chaining hash-based container has the following declaration.

```
template<
  typename Key,
  typename Mapped,
  typename Hash_Fn = std::hash<Key>,
  typename Eq_Fn = std::equal_to<Key>,
  typename Comb_Hash_Fn = direct_mask_range_hashing<>
  typename Resize_Policy = default explained below.
  bool Store_Hash = false,
  typename Allocator = std::allocator<char> >
  class cc_hash_table;
```

The parameters have the following meaning:

1. `Key` is the key type.
2. `Mapped` is the mapped-policy.
3. `Hash_Fn` is a key hashing functor.
4. `Eq_Fn` is a key equivalence functor.
5. `Comb_Hash_Fn` is a range-hashing functor; it describes how to translate hash values into positions within the table.
6. `Resize_Policy` describes how a container object should change its internal size.
7. `Store_Hash` indicates whether the hash value should be stored with each entry.
8. `Allocator` is an allocator type.

The probing hash-based container has the following declaration.

```
template<
  typename Key,
  typename Mapped,
  typename Hash_Fn = std::hash<Key>,
  typename Eq_Fn = std::equal_to<Key>,
  typename Comb_Probe_Fn = direct_mask_range_hashing<>
  typename Probe_Fn = default explained below.
```

```
typename Resize_Policy = default explained below.  
bool Store_Hash = false,  
typename Allocator = std::allocator<char> >  
class gp_hash_table;
```

The parameters are identical to those of the collision-chaining container, except for the following.

1. `Comb_Probe_Fn` describes how to transform a probe sequence into a sequence of positions within the table.
2. `Probe_Fn` describes a probe sequence policy.

Some of the default template values depend on the values of other parameters, and are explained below.

22.3.2.1.2 Details

22.3.2.1.2.1 Hash Policies

22.3.2.1.2.2 General

Following is an explanation of some functions which hashing involves. The graphic below illustrates the discussion.

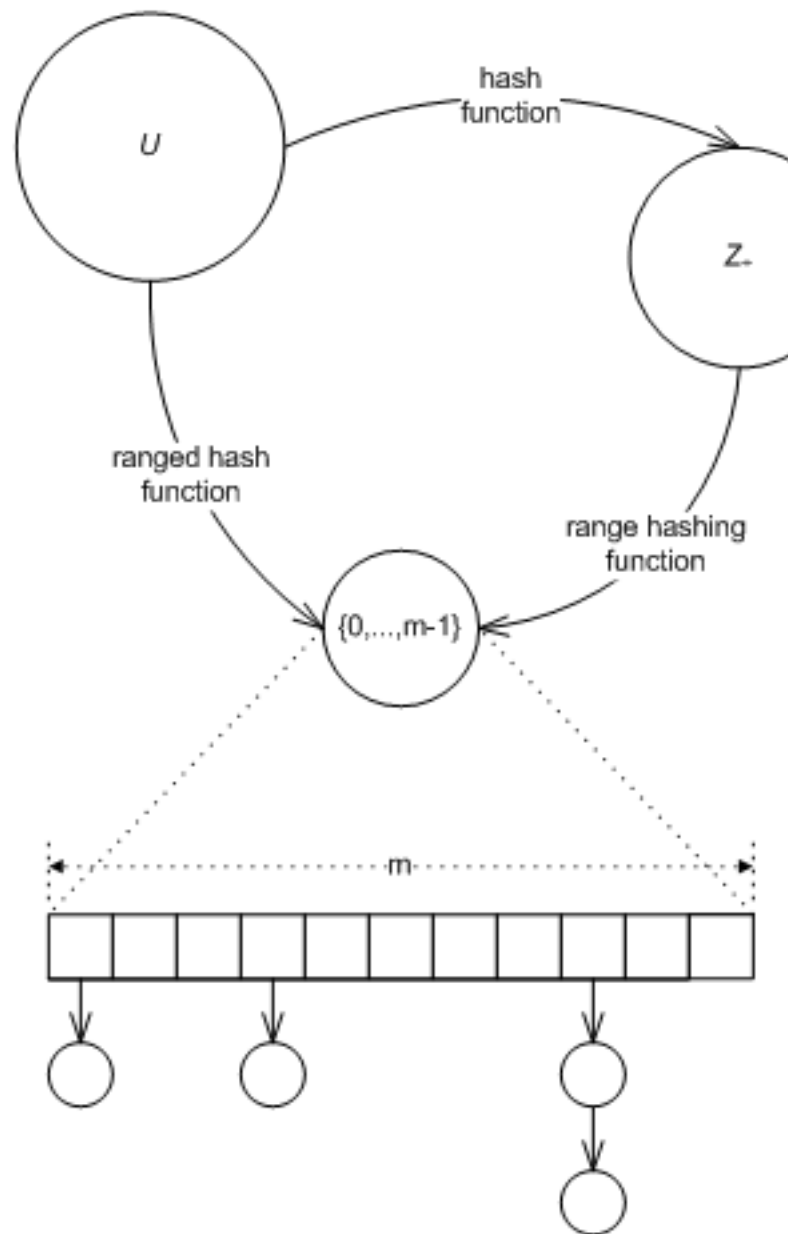

Figure 22.14: Hash functions, ranged-hash functions, and range-hashing functions

Let U be a domain (e.g., the integers, or the strings of 3 characters). A hash-table algorithm needs to map elements of U "uniformly" into the range $[0, \dots, m - 1]$ (where m is a non-negative integral value, and is, in general, time varying). I.e., the algorithm needs a ranged-hash function

$$f : U \times \mathbb{Z}_+ \rightarrow \mathbb{Z}_+$$

such that for any u in U ,

$$0 \leq f(u, m) \leq m - 1$$

and which has "good uniformity" properties (say [77].) One common solution is to use the composition of the hash function

$$h : U \rightarrow \mathbb{Z}_+,$$

which maps elements of U into the non-negative integers, and

$$g : \mathbb{Z}_+ \times \mathbb{Z}_+ \rightarrow \mathbb{Z}_+,$$

which maps a non-negative hash value, and a non-negative range upper-bound into a non-negative integral in the range between 0 (inclusive) and the range upper bound (exclusive), i.e., for any r in \mathbb{Z}_+ ,

$$0 \leq g(r, m) \leq m - 1$$

The resulting ranged-hash function, is

$$f(u, m) = g(h(u), m)$$

EQUATION 22.1: Ranged Hash Function

From the above, it is obvious that given g and h , f can always be composed (however the converse is not true). The standard's hash-based containers allow specifying a hash function, and use a hard-wired range-hashing function; the ranged-hash function is implicitly composed.

The above describes the case where a key is to be mapped into a single position within a hash table, e.g., in a collision-chaining table. In other cases, a key is to be mapped into a sequence of positions within a table, e.g., in a probing table. Similar terms apply in this case: the table requires a ranged probe function, mapping a key into a sequence of positions within the table. This is typically achieved by composing a hash function mapping the key into a non-negative integral type, a probe function transforming the hash value into a sequence of hash values, and a range-hashing function transforming the sequence of hash values into a sequence of positions.

22.3.2.1.2.3 Range Hashing

Some common choices for range-hashing functions are the division, multiplication, and middle-square methods ([77]), defined as

$$g(r, m) = r \bmod m$$

EQUATION 22.2: Range-Hashing, Division Method

$$g(r, m) = \lceil u/v (a r \bmod v) \rceil$$

and

$$g(r, m) = \lceil u/v (r^2 \bmod v) \rceil$$

respectively, for some positive integrals u and v (typically powers of 2), and some a . Each of these range-hashing functions works best for some different setting.

The division method (see above) is a very common choice. However, even this single method can be implemented in two very different ways. It is possible to implement using the low level `%` (modulo) operation (for any m), or the low level `&` (bit-mask) operation (for the case where m is a power of 2), i.e.,

$$g(r, m) = r \% m$$

EQUATION 22.3: Division via Prime Modulo

and

$$g(r, m) = r \& m - 1, \text{ (with } m = 2^k \text{ for some } k)$$

EQUATION 22.4: Division via Bit Mask

respectively.

The `%` (modulo) implementation has the advantage that for m a prime far from a power of 2, $g(r, m)$ is affected by all the bits of r (minimizing the chance of collision). It has the disadvantage of using the costly modulo operation. This method is hard-wired into SGI's implementation.

The `&` (bit-mask) implementation has the advantage of relying on the fast bit-wise and operation. It has the disadvantage that for $g(r, m)$ is affected only by the low order bits of r . This method is hard-wired into Dinkumware's implementation.

22.3.2.1.2.4 Ranged Hash

In cases it is beneficial to allow the client to directly specify a ranged-hash hash function. It is true, that the writer of the ranged-hash function cannot rely on the values of m having specific numerical properties suitable for hashing (in the sense used in [77]), since the values of m are determined by a resize policy with possibly orthogonal considerations.

There are two cases where a ranged-hash function can be superior. The first is when using perfect hashing: the second is when the values of m can be used to estimate the "general" number of distinct values required. This is described in the following.

Let

$$s = [s_0, \dots, s_{t-1}]$$

be a string of t characters, each of which is from domain S . Consider the following ranged-hash function:

$$f_1(s, m) = \sum_{i=0}^{t-1} s_i a^i \bmod m$$

EQUATION 22.5: A Standard String Hash Function

where a is some non-negative integral value. This is the standard string-hashing function used in SGI's implementation (with $a = 5$). Its advantage is that it takes into account all of the characters of the string.

Now assume that s is the string representation of a long DNA sequence (and so $S = \{'A', 'C', 'G', 'T'\}$). In this case, scanning the entire string might be prohibitively expensive. A possible alternative might be to use only the first k characters of the string, where

$$|S|^k \geq m,$$

i.e., using the hash function

$$f_2(s, m) = \sum_{i=0}^{k-1} s_i a^i \bmod m$$

EQUATION 22.6: Only k String DNA Hash

requiring scanning over only

$$k = \log_4(m)$$

characters.

Other more elaborate hash-functions might scan k characters starting at a random position (determined at each resize), or scanning k random positions (determined at each resize), i.e., using

$$f_3(s, m) = \sum_{i=r_0}^{r_0+k-1} s_i a^i \bmod m,$$

or

$$f_4(s, m) = \sum_{i=0}^{k-1} s_{r_i} a^{r_i} \bmod m,$$

respectively, for r_0, \dots, r_{k-1} each in the (inclusive) range $[0, \dots, t-1]$.

It should be noted that the above functions cannot be decomposed as per a ranged hash composed of hash and range hashing.

22.3.2.1.2.5 Implementation

This sub-subsection describes the implementation of the above in this library. It first explains range-hashing functions in collision-chaining tables, then ranged-hash functions in collision-chaining tables, then probing-based tables, and finally lists the relevant classes in this library.

22.3.2.1.2.6 Range-Hashing and Ranged-Hashes in Collision-Chaining Tables

`cc_hash_table` is parametrized by `Hash_Fn` and `Comb_Hash_Fn`, a hash functor and a combining hash functor, respectively.

In general, `Comb_Hash_Fn` is considered a range-hashing functor. `cc_hash_table` synthesizes a ranged-hash function from `Hash_Fn` and `Comb_Hash_Fn`. The figure below shows an `insert` sequence diagram for this case. The user inserts an element (point A), the container transforms the key into a non-negative integral using the hash functor (points B and C), and transforms the result into a position using the combining functor (points D and E).

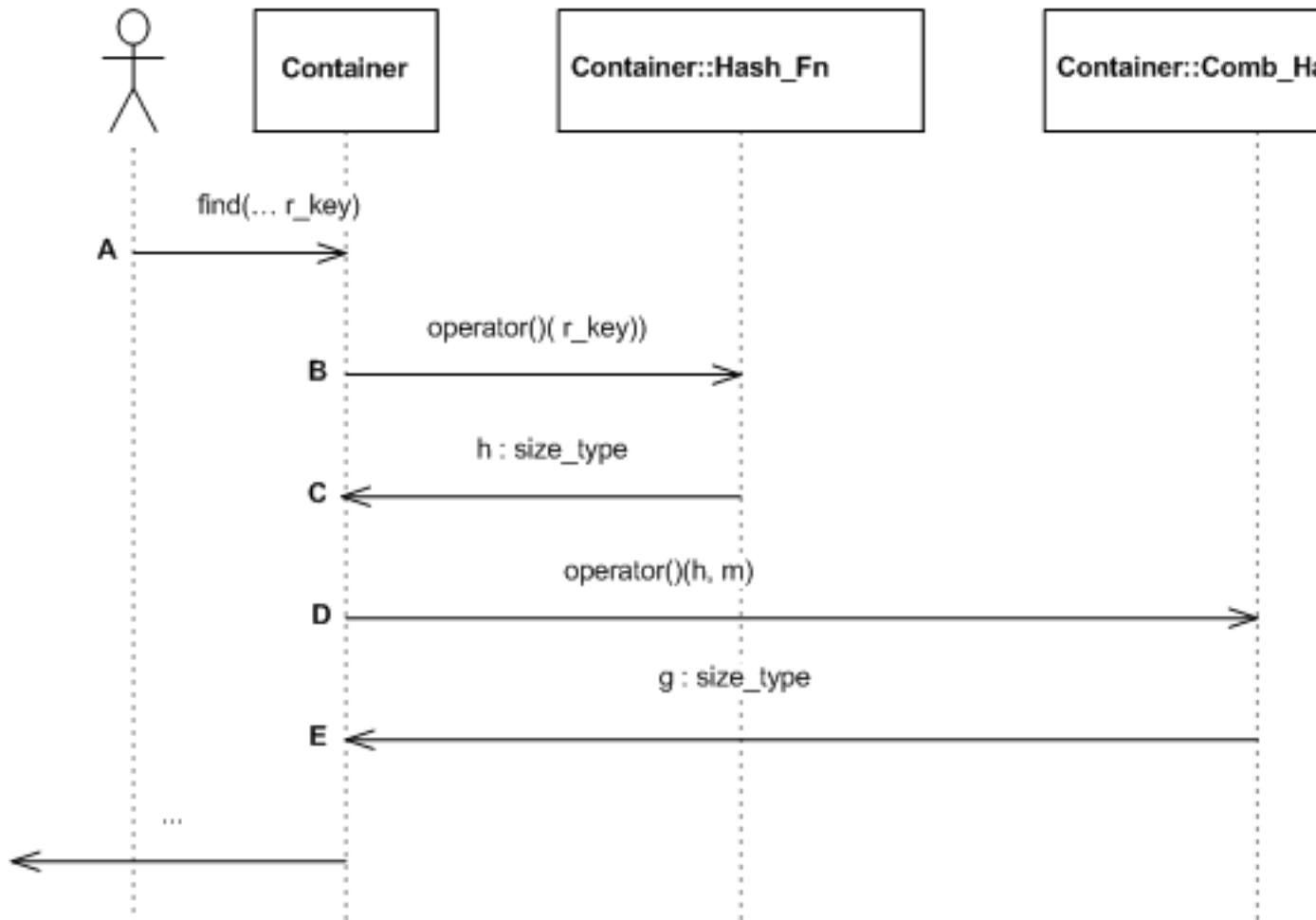

Figure 22.15: Insert hash sequence diagram

If `cc_hash_table`'s hash-functor, `Hash_Fn` is instantiated by `null_type`, then `Comb_Hash_Fn` is taken to be a ranged-hash function. The graphic below shows an `insert` sequence diagram. The user inserts an element (point A), the container transforms the key into a position using the combining functor (points B and C).

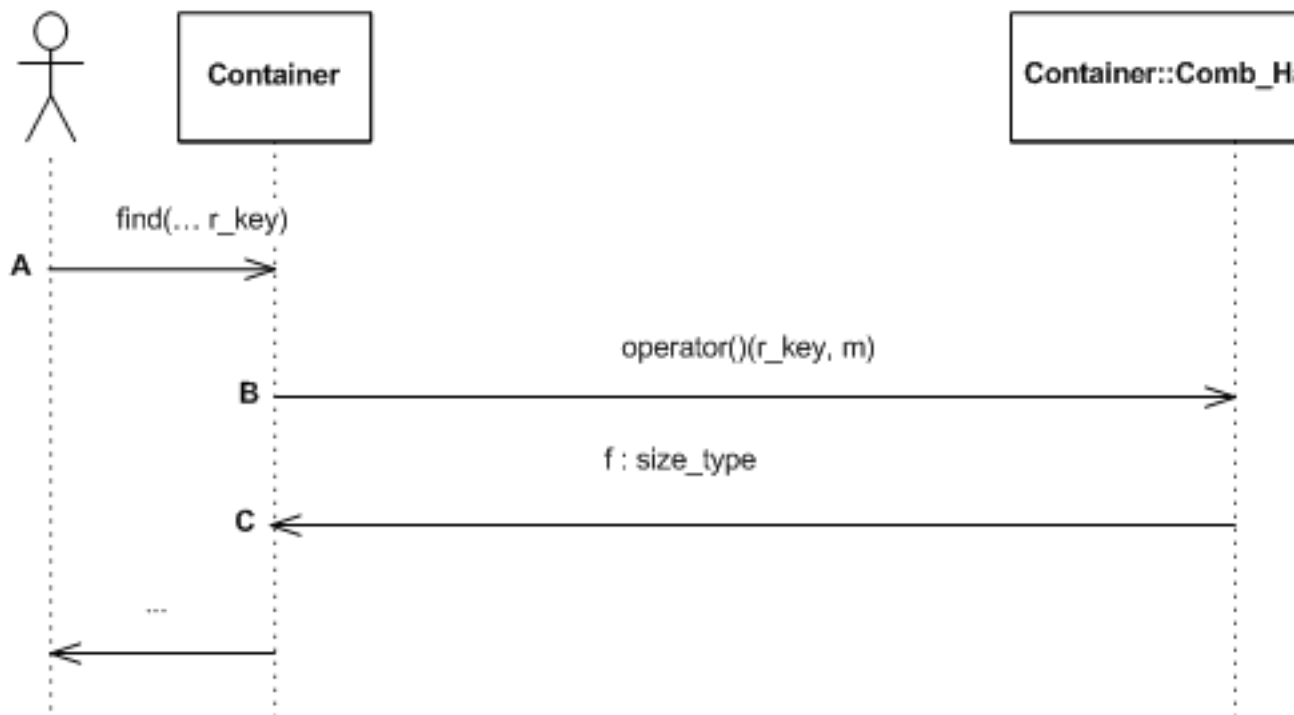

Figure 22.16: Insert hash sequence diagram with a null policy

22.3.2.1.2.7 Probing tables

gp_hash_table is parametrized by Hash_Fn, Probe_Fn, and Comb_Probe_Fn. As before, if Hash_Fn and Probe_Fn are both null_type, then Comb_Probe_Fn is a ranged-probe functor. Otherwise, Hash_Fn is a hash functor, Probe_Fn is a functor for offsets from a hash value, and Comb_Probe_Fn transforms a probe sequence into a sequence of positions within the table.

22.3.2.1.2.8 Pre-Defined Policies

This library contains some pre-defined classes implementing range-hashing and probing functions:

1. direct_mask_range_hashing and direct_mod_range_hashing are range-hashing functions based on a bit-mask and a modulo operation, respectively.
2. linear_probe_fn, and quadratic_probe_fn are a linear probe and a quadratic probe function, respectively.

The graphic below shows the relationships.

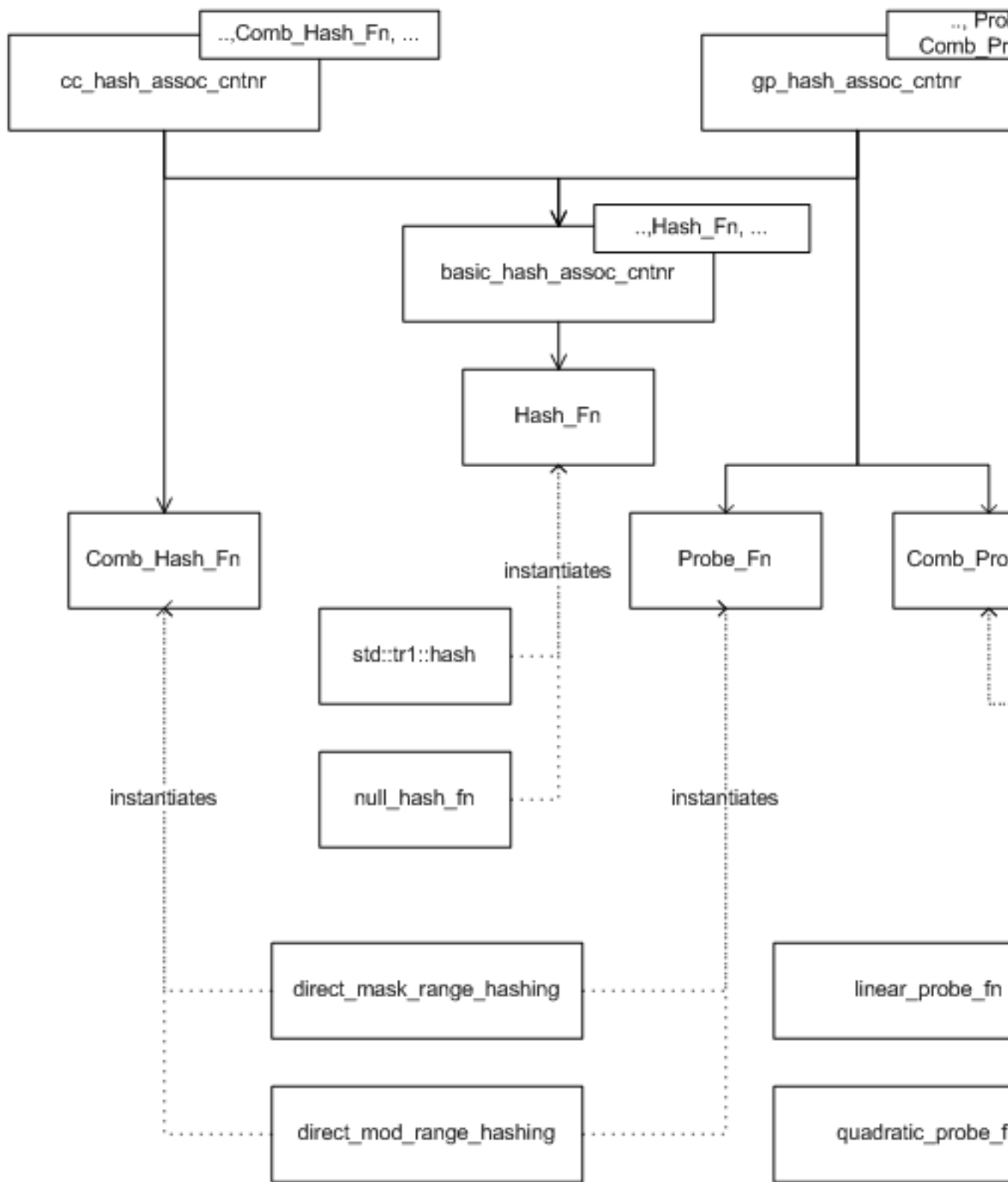

Figure 22.17: Hash policy class diagram

22.3.2.1.2.9 Resize Policies

22.3.2.1.2.10 General

Hash-tables, as opposed to trees, do not naturally grow or shrink. It is necessary to specify policies to determine how and when a hash table should change its size. Usually, resize policies can be decomposed into orthogonal policies:

1. A size policy indicating how a hash table should grow (e.g., it should multiply by powers of 2).
2. A trigger policy indicating when a hash table should grow (e.g., a load factor is exceeded).

22.3.2.1.2.11 Size Policies

Size policies determine how a hash table changes size. These policies are simple, and there are relatively few sensible options. An exponential-size policy (with the initial size and growth factors both powers of 2) works well with a mask-based range-hashing function, and is the hard-wired policy used by Dinkumware. A prime-list based policy works well with a modulo-prime range hashing function and is the hard-wired policy used by SGI's implementation.

22.3.2.1.2.12 Trigger Policies

Trigger policies determine when a hash table changes size. Following is a description of two policies: load-check policies, and collision-check policies.

Load-check policies are straightforward. The user specifies two factors, A_{min} and A_{max} , and the hash table maintains the invariant that

$$A_{min} \leq (\text{number of stored elements}) / (\text{hash-table size}) \leq A_{max}$$

Collision-check policies work in the opposite direction of load-check policies. They focus on keeping the number of collisions moderate and hoping that the size of the table will not grow very large, instead of keeping a moderate load-factor and hoping that the number of collisions will be small. A maximal collision-check policy resizes when the longest probe-sequence grows too large.

Consider the graphic below. Let the size of the hash table be denoted by m , the length of a probe sequence be denoted by k , and some load factor be denoted by A . We would like to calculate the minimal length of k , such that if there were $A \cdot m$ elements in the hash table, a probe sequence of length k would be found with probability at most $1/m$.

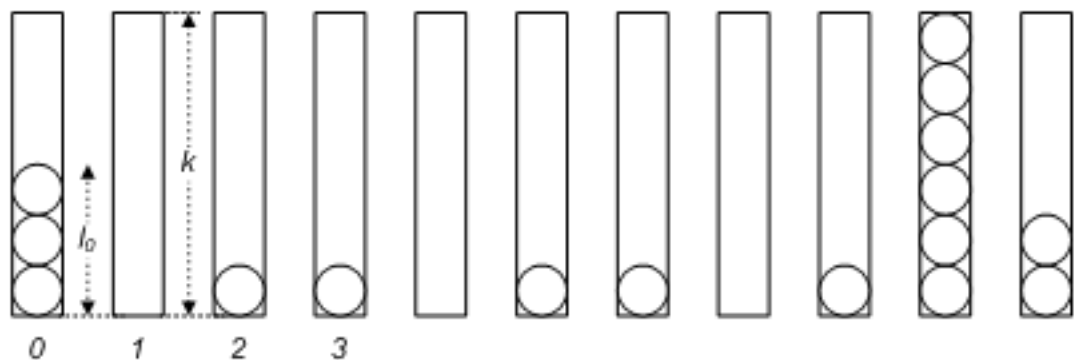

Figure 22.18: Balls and bins

Denote the probability that a probe sequence of length k appears in bin i by p_i , the length of the probe sequence of bin i by l_i , and assume uniform distribution. Then

$$p_i =$$

EQUATION 22.7: Probability of Probe Sequence of Length k

$P(l_i \geq k) =$

$P(l_i \geq \alpha (1 + k / \alpha - 1)) \leq (a)$

$e^{-\alpha (k / \alpha - 1)^2 / 2}$

where (a) follows from the Chernoff bound ([85]). To calculate the probability that some bin contains a probe sequence greater than k , we note that the l_i are negatively-dependent ([67]). Let $I(\cdot)$ denote the indicator function. Then

$P(\text{exists } i; l_i \geq k) =$

EQUATION 22.8: Probability Probe Sequence in Some Bin

$P(\sum_{i=1}^m I(l_i \geq k) \geq 1) =$

$P(\sum_{i=1}^m I(l_i \geq k) \geq m p_1 (1 + 1 / (m p_1) - 1)) \leq (a)$

$e^{-m p_1 (1 / (m p_1) - 1)^2 / 2},$

where (a) follows from the fact that the Chernoff bound can be applied to negatively-dependent variables ([67]). Inserting the first probability equation into the second one, and equating with $1/m$, we obtain

$k \sim \sqrt{(2 \alpha \ln 2 m \ln(m))}.$

22.3.2.1.2.13 Implementation

This sub-subsection describes the implementation of the above in this library. It first describes resize policies and their decomposition into trigger and size policies, then describes pre-defined classes, and finally discusses controlled access the policies' internals.

22.3.2.1.2.14 Decomposition

Each hash-based container is parametrized by a `Resize_Policy` parameter; the container derives publicly from `Resize_Policy`. For example:

```
cc_hash_table<typename Key,
typename Mapped,
...
typename Resize_Policy
...> : public Resize_Policy
```

As a container object is modified, it continuously notifies its `Resize_Policy` base of internal changes (e.g., collisions encountered and elements being inserted). It queries its `Resize_Policy` base whether it needs to be resized, and if so, to what size.

The graphic below shows a (possible) sequence diagram of an insert operation. The user inserts an element; the hash table notifies its resize policy that a search has started (point A); in this case, a single collision is encountered - the table notifies its resize policy of this (point B); the container finally notifies its resize policy that the search has ended (point C); it then queries its resize policy whether a resize is needed, and if so, what is the new size (points D to G); following the resize, it notifies the policy that a resize has completed (point H); finally, the element is inserted, and the policy notified (point I).

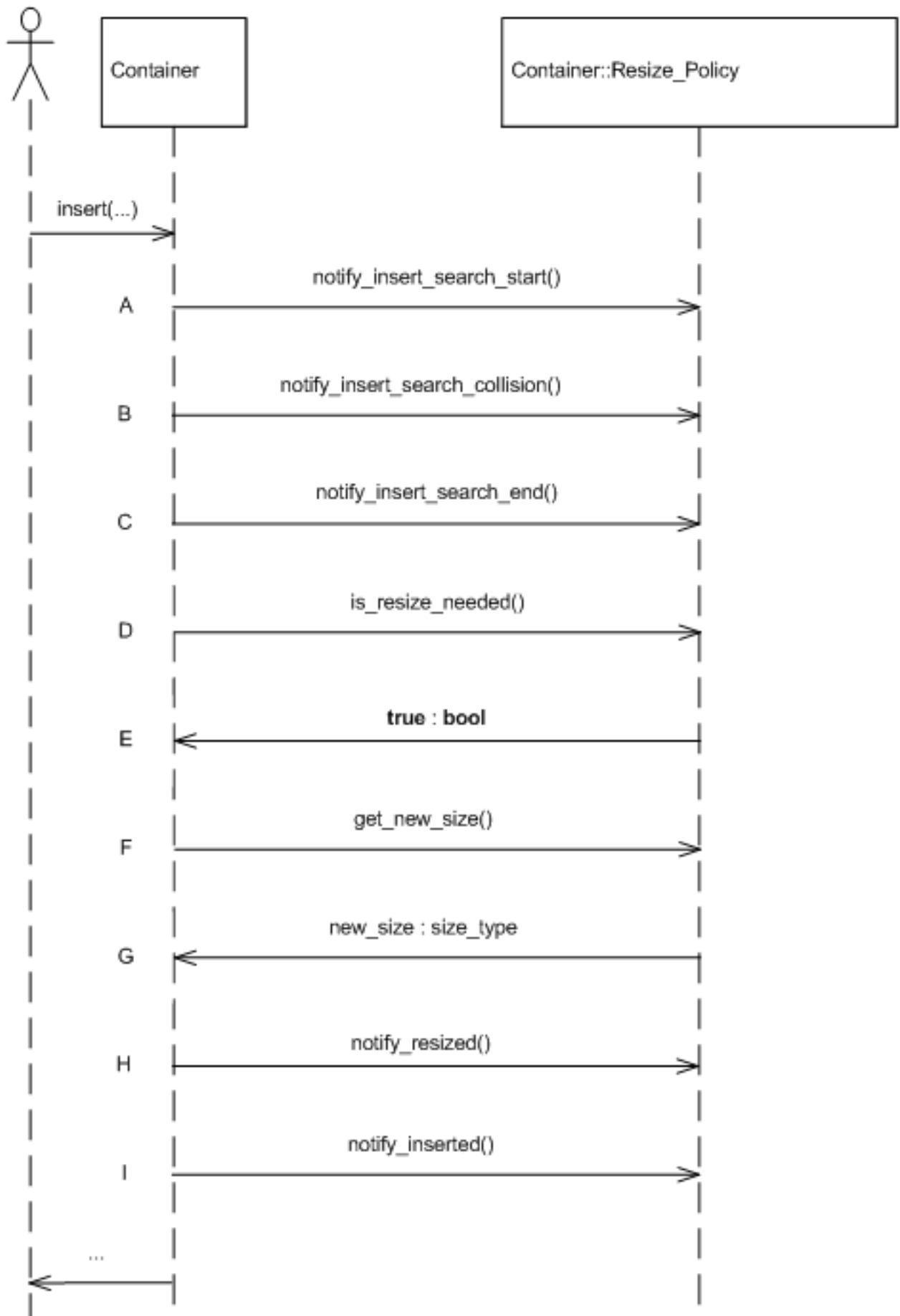

Figure 22.19: Insert resize sequence diagram

In practice, a resize policy can be usually orthogonally decomposed to a size policy and a trigger policy. Consequently, the library contains a single class for instantiating a resize policy: `hash_standard_resize_policy` is parametrized by `Size_Policy` and `Trigger_Policy`, derives publicly from both, and acts as a standard delegate ([71]) to these policies.

The two graphics immediately below show sequence diagrams illustrating the interaction between the standard resize policy and its trigger and size policies, respectively.

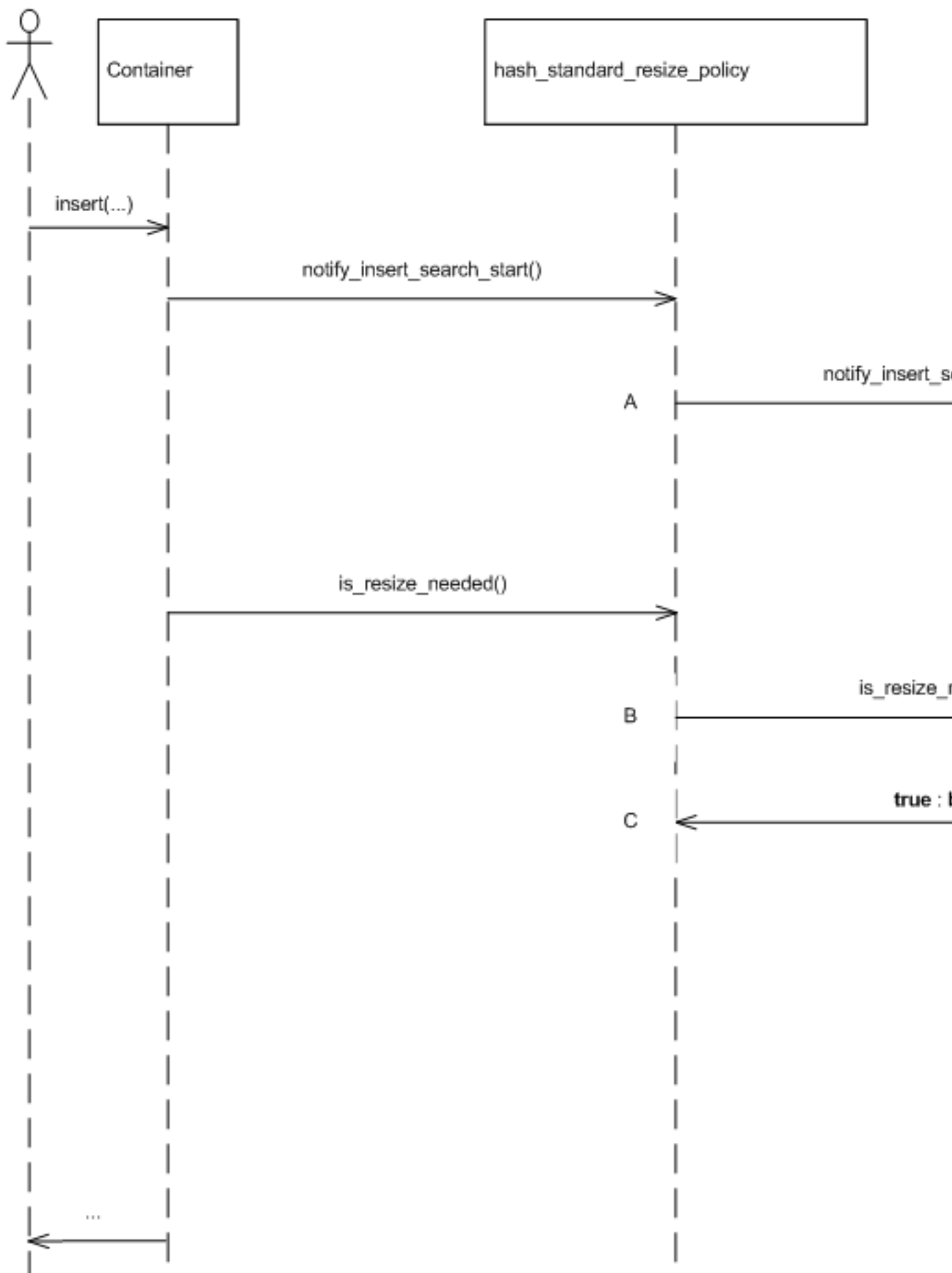

Figure 22.20: Standard resize policy trigger sequence diagram

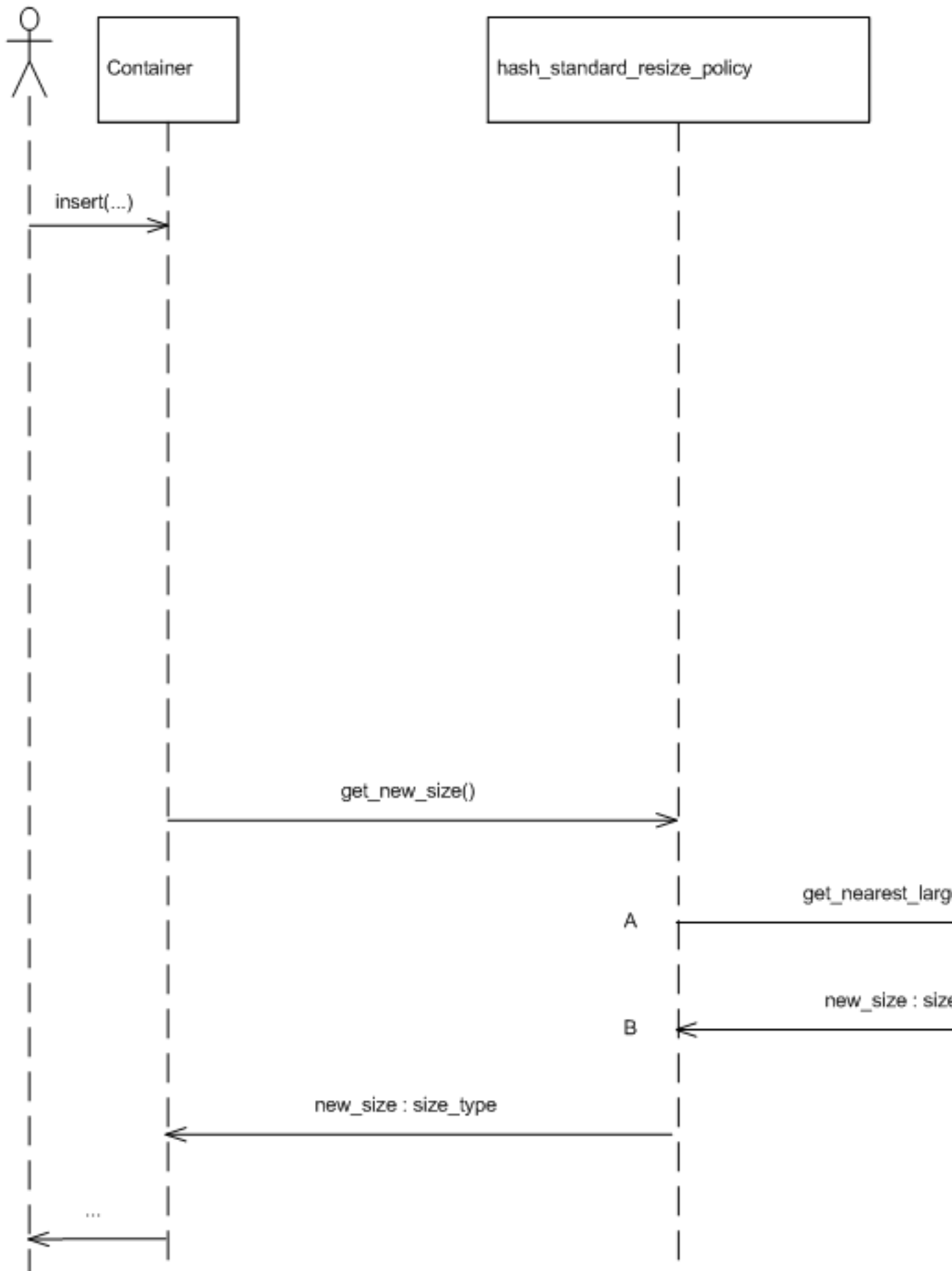

Figure 22.21: Standard resize policy size sequence diagram

22.3.2.1.2.15 Predefined Policies

The library includes the following instantiations of size and trigger policies:

1. `hash_load_check_resize_trigger` implements a load check trigger policy.
2. `cc_hash_max_collision_check_resize_trigger` implements a collision check trigger policy.
3. `hash_exponential_size_policy` implements an exponential-size policy (which should be used with mask range hashing).
4. `hash_prime_size_policy` implementing a size policy based on a sequence of primes (which should be used with mod range hashing).

The graphic below gives an overall picture of the resize-related classes. `basic_hash_table` is parametrized by `Resize_Policy`, which it subclasses publicly. This class is currently instantiated only by `hash_standard_resize_policy`. `hash_standard_resize_policy` itself is parametrized by `Trigger_Policy` and `Size_Policy`. Currently, `Trigger_Policy` is instantiated by `hash_load_check_resize_trigger`, or `cc_hash_max_collision_check_resize_trigger`; `Size_Policy` is instantiated by `hash_exponential_size_policy`, or `hash_prime_size_policy`.

22.3.2.1.2.16 Controlling Access to Internals

There are cases where (controlled) access to resize policies' internals is beneficial. E.g., it is sometimes useful to query a hash-table for the table's actual size (as opposed to its `size()` - the number of values it currently holds); it is sometimes useful to set a table's initial size, externally resize it, or change load factors.

Clearly, supporting such methods both decreases the encapsulation of hash-based containers, and increases the diversity between different associative-containers' interfaces. Conversely, omitting such methods can decrease containers' flexibility.

In order to avoid, to the extent possible, the above conflict, the hash-based containers themselves do not address any of these questions; this is deferred to the resize policies, which are easier to change or replace. Thus, for example, neither `cc_hash_table` nor `gp_hash_table` contain methods for querying the actual size of the table; this is deferred to `hash_standard_resize_policy`.

Furthermore, the policies themselves are parametrized by template arguments that determine the methods they support ([56] shows techniques for doing so). `hash_standard_resize_policy` is parametrized by `External_Size_Access` that determines whether it supports methods for querying the actual size of the table or resizing it. `hash_load_check_resize_trigger` is parametrized by `External_Load_Access` that determines whether it supports methods for querying or modifying the loads. `cc_hash_max_collision_check_resize_trigger` is parametrized by `External_Load_Access` that determines whether it supports methods for querying the load.

Some operations, for example, resizing a container at run time, or changing the load factors of a load-check trigger policy, require the container itself to resize. As mentioned above, the hash-based containers themselves do not contain these types of methods, only their resize policies. Consequently, there must be some mechanism for a resize policy to manipulate the hash-based container. As the hash-based container is a subclass of the resize policy, this is done through virtual methods. Each hash-based container has a private virtual method:

```
virtual void
do_resize
(size_type new_size);
```

which resizes the container. Implementations of `Resize_Policy` can export public methods for resizing the container externally; these methods internally call `do_resize` to resize the table.

22.3.2.1.2.17 Policy Interactions

Hash-tables are unfortunately especially susceptible to choice of policies. One of the more complicated aspects of this is that poor combinations of good policies can form a poor container. Following are some considerations.

22.3.2.1.2.18 probe/size/trigger

Some combinations do not work well for probing containers. For example, combining a quadratic probe policy with an exponential size policy can yield a poor container: when an element is inserted, a trigger policy might decide that there is no need to resize, as the table still contains unused entries; the probe sequence, however, might never reach any of the unused entries.

Unfortunately, this library cannot detect such problems at compilation (they are halting reducible). It therefore defines an exception class `insert_error` to throw an exception in this case.

22.3.2.1.2.19 hash/trigger

Some trigger policies are especially susceptible to poor hash functions. Suppose, as an extreme case, that the hash function transforms each key to the same hash value. After some inserts, a collision detecting policy will always indicate that the container needs to grow.

The library, therefore, by design, limits each operation to one resize. For each `insert`, for example, it queries only once whether a resize is needed.

22.3.2.1.2.20 equivalence functors/storing hash values/hash

`cc_hash_table` and `gp_hash_table` are parametrized by an equivalence functor and by a `Store_Hash` parameter. If the latter parameter is `true`, then the container stores with each entry a hash value, and uses this value in case of collisions to determine whether to apply a hash value. This can lower the cost of collision for some types, but increase the cost of collisions for other types.

If a ranged-hash function or ranged probe function is directly supplied, however, then it makes no sense to store the hash value with each entry. This library's container will fail at compilation, by design, if this is attempted.

22.3.2.1.2.21 size/load-check trigger

Assume a size policy issues an increasing sequence of sizes a , $a q$, $a q^1$, $a q^2$, ... For example, an exponential size policy might issue the sequence of sizes 8, 16, 32, 64, ...

If a load-check trigger policy is used, with loads α_{\min} and α_{\max} , respectively, then it is a good idea to have:

1. $\alpha_{\max} \sim 1 / q$
2. $\alpha_{\min} < 1 / (2 q)$

This will ensure that the amortized hash cost of each modifying operation is at most approximately 3.

$\alpha_{\min} \sim \alpha_{\max}$ is, in any case, a bad choice, and $\alpha_{\min} > \alpha_{\max}$ is horrendous.

22.3.2.2 tree

22.3.2.2.1 Interface

The tree-based container has the following declaration:

```
template<
  typename Key,
  typename Mapped,
  typename Cmp_Fn = std::less<Key>,
  typename Tag = rb_tree_tag,
  template<
    typename Const_Node_Iterator,
    typename Node_Iterator,
    typename Cmp_Fn_,
    typename Allocator_>
    class Node_Update = null_node_update,
  typename Allocator = std::allocator<char> >
  class tree;
```

The parameters have the following meaning:

1. `Key` is the key type.
2. `Mapped` is the mapped-policy.
3. `Cmp_Fn` is a key comparison functor
4. `Tag` specifies which underlying data structure to use.
5. `Node_Update` is a policy for updating node invariants.
6. `Allocator` is an allocator type.

The `Tag` parameter specifies which underlying data structure to use. Instantiating it by `rb_tree_tag`, `splay_tree_tag`, or `ov_tree_tag`, specifies an underlying red-black tree, splay tree, or ordered-vector tree, respectively; any other tag is illegal. Note that containers based on the former two contain more types and methods than the latter (e.g., `reverse_iterator` and `rbegin`), and different exception and invalidation guarantees.

22.3.2.2.2 Details

22.3.2.2.2.1 Node Invariants

Consider the two trees in the graphic below, labels A and B. The first is a tree of floats; the second is a tree of pairs, each signifying a geometric line interval. Each element in a tree is referred to as a node of the tree. Of course, each of these trees can support the usual queries: the first can easily search for `0.4`; the second can easily search for `std::make_pair(10, 41)`.

Each of these trees can efficiently support other queries. The first can efficiently determine that the 2rd key in the tree is `0.3`; the second can efficiently determine whether any of its intervals overlaps

```
std::make_pair(29, 42)
```

(useful in geometric applications or distributed file systems with leases, for example). It should be noted that an `std::set` can only solve these types of problems with linear complexity.

In order to do so, each tree stores some metadata in each node, and maintains node invariants (see [66].) The first stores in each node the size of the sub-tree rooted at the node; the second stores at each node the maximal endpoint of the intervals at the sub-tree rooted at the node.

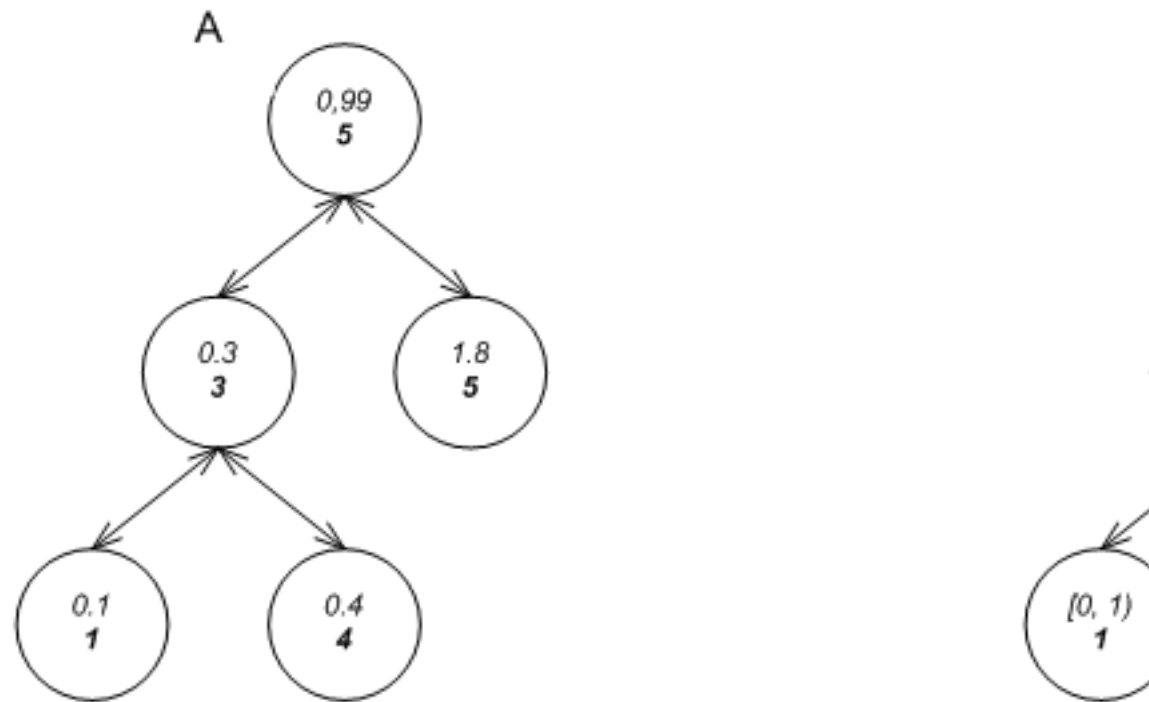

Figure 22.22: Tree node invariants

Supporting such trees is difficult for a number of reasons:

1. There must be a way to specify what a node's metadata should be (if any).
2. Various operations can invalidate node invariants. The graphic below shows how a right rotation, performed on A, results in B, with nodes x and y having corrupted invariants (the grayed nodes in C). The graphic shows how an insert, performed on D, results in E, with nodes x and y having corrupted invariants (the grayed nodes in F). It is not feasible to know outside the tree the effect of an operation on the nodes of the tree.
3. The search paths of standard associative containers are defined by comparisons between keys, and not through metadata.
4. It is not feasible to know in advance which methods trees can support. Besides the usual `find` method, the first tree can support a `find_by_order` method, while the second can support an `overlaps` method.

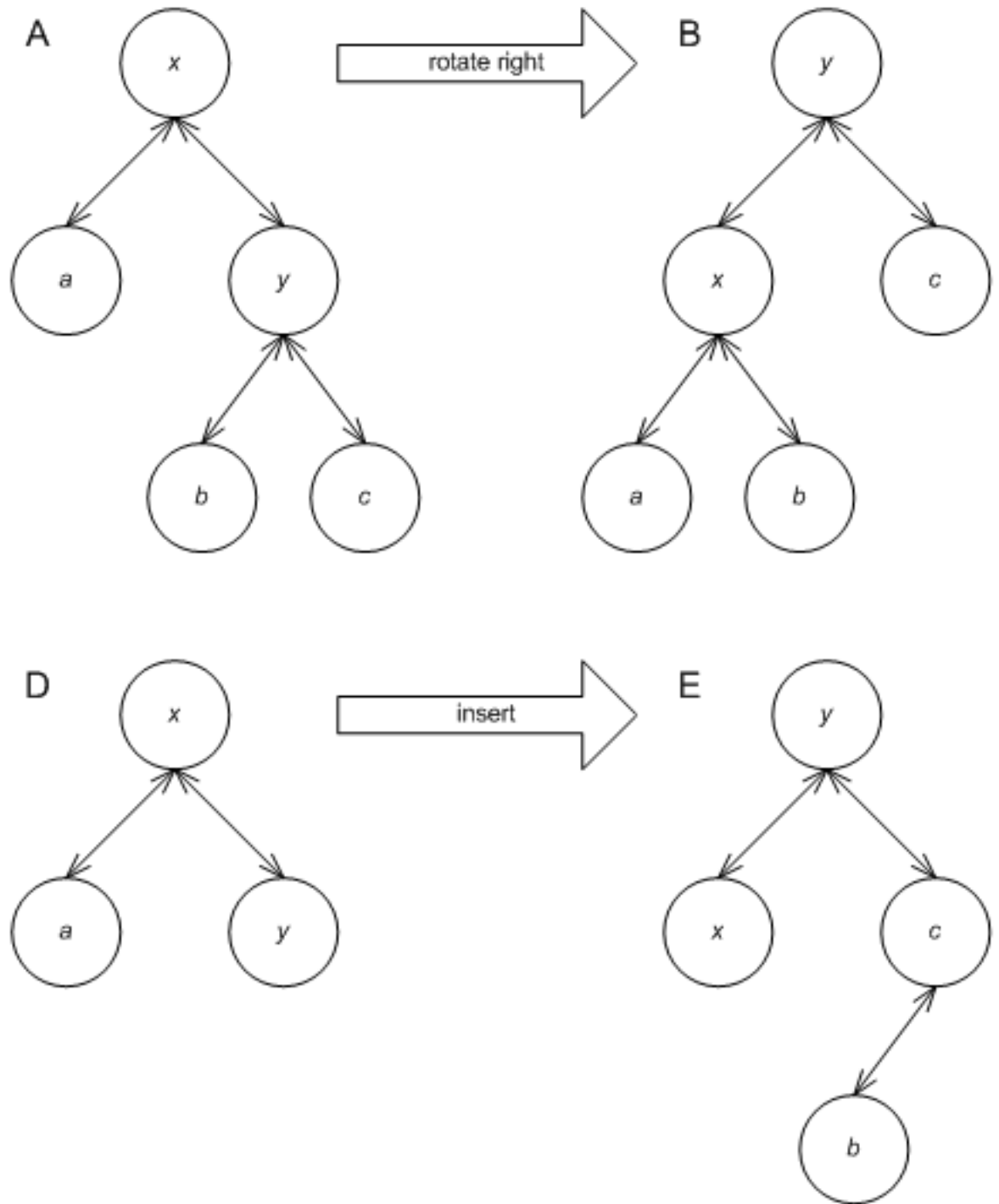

Figure 22.23: Tree node invalidation

These problems are solved by a combination of two means: node iterators, and template-template node updater parameters.

22.3.2.2.2 Node Iterators

Each tree-based container defines two additional iterator types, `const_node_iterator` and `node_iterator`. These iterators allow descending from a node to one of its children. Node iterator allow search paths different than those determined by the comparison functor. The `tree` supports the methods:

```
const_node_iterator
node_begin() const;

node_iterator
node_begin();

const_node_iterator
node_end() const;

node_iterator
node_end();
```

The first pairs return node iterators corresponding to the root node of the tree; the latter pair returns node iterators corresponding to a just-after-leaf node.

22.3.2.2.3 Node Updator

The tree-based containers are parametrized by a `Node_Update` template-template parameter. A tree-based container instantiates `Node_Update` to some `node_update` class, and publicly subclasses `node_update`. The graphic below shows this scheme, as well as some predefined policies (which are explained below).

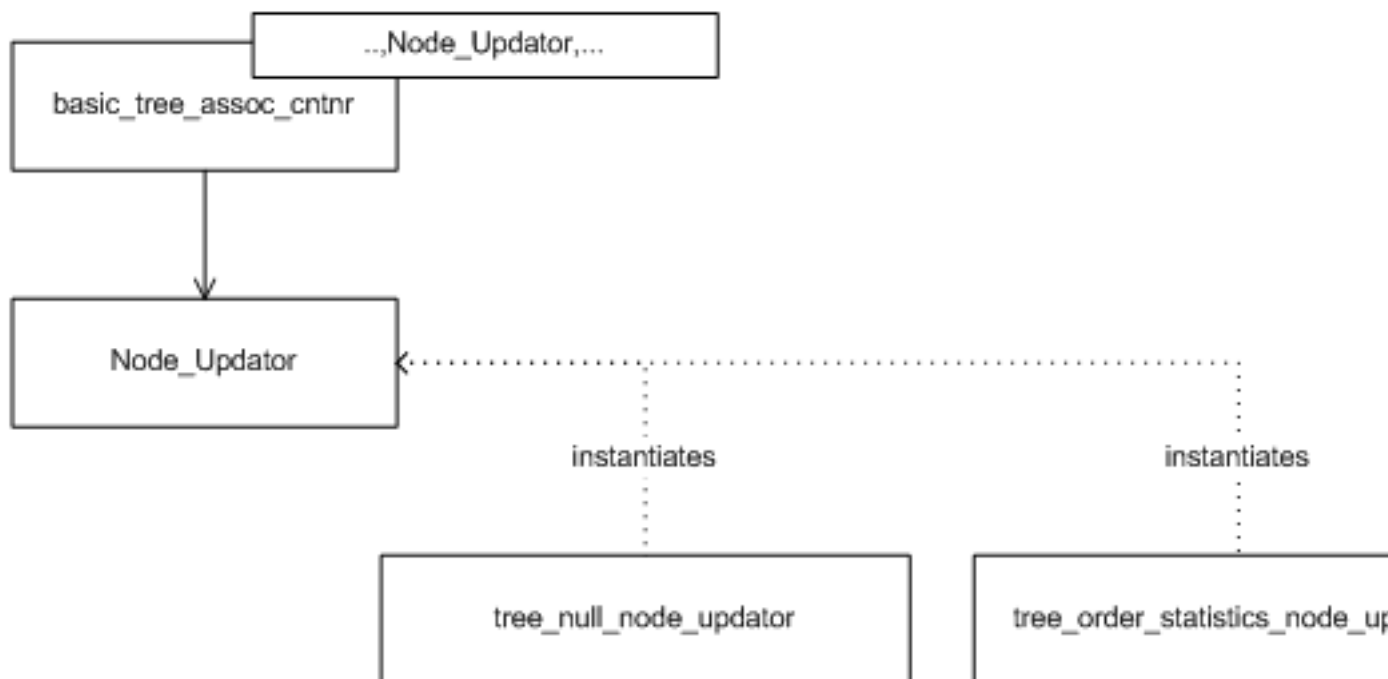

Figure 22.24: A tree and its update policy

`node_update` (an instantiation of `Node_Update`) must define `metadata_type` as the type of metadata it requires. For order statistics, e.g., `metadata_type` might be `size_t`. The tree defines within each node a `metadata_type` object.

`node_update` must also define the following method for restoring node invariants:

```
void
operator()(node_iterator nd_it, const_node_iterator end_nd_it)
```

In this method, `nd_it` is a `node_iterator` corresponding to a node whose A) all descendants have valid invariants, and B) its own invariants might be violated; `end_nd_it` is a `const_node_iterator` corresponding to a just-after-leaf node. This method should correct the node invariants of the node pointed to by `nd_it`. For example, say node `x` in the graphic below label A has an invalid invariant, but its children, `y` and `z` have valid invariants. After the invocation, all three nodes should have valid invariants, as in label B.

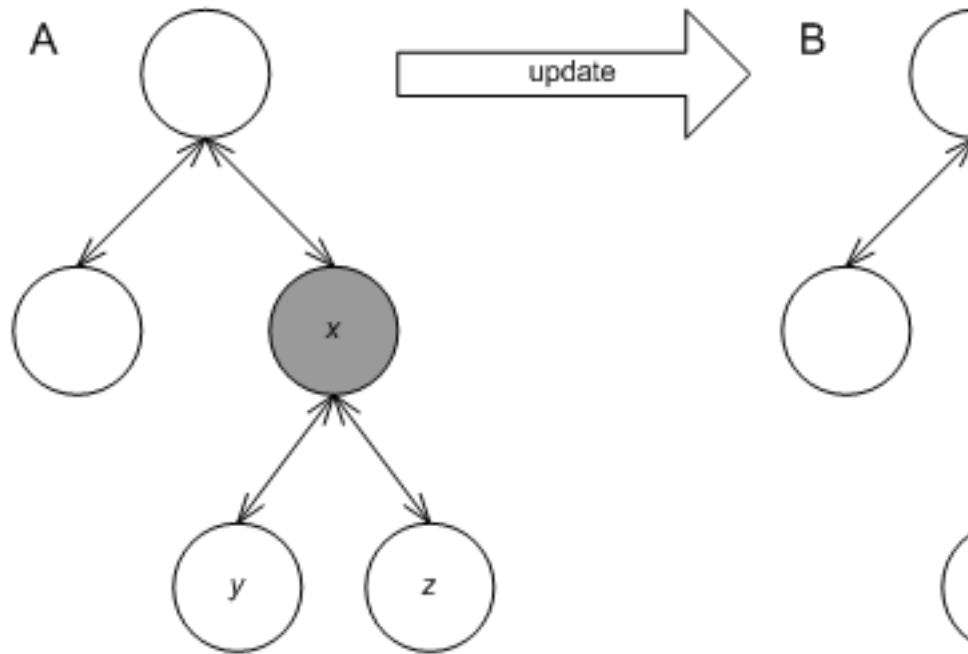

Figure 22.25: Restoring node invariants

When a tree operation might invalidate some node invariant, it invokes this method in its `node_update` base to restore the invariant. For example, the graphic below shows an `insert` operation (point A); the tree performs some operations, and calls the update functor three times (points B, C, and D). (It is well known that any `insert`, `erase`, `split` or `join`, can restore all node invariants by a small number of node invariant updates ([66]).

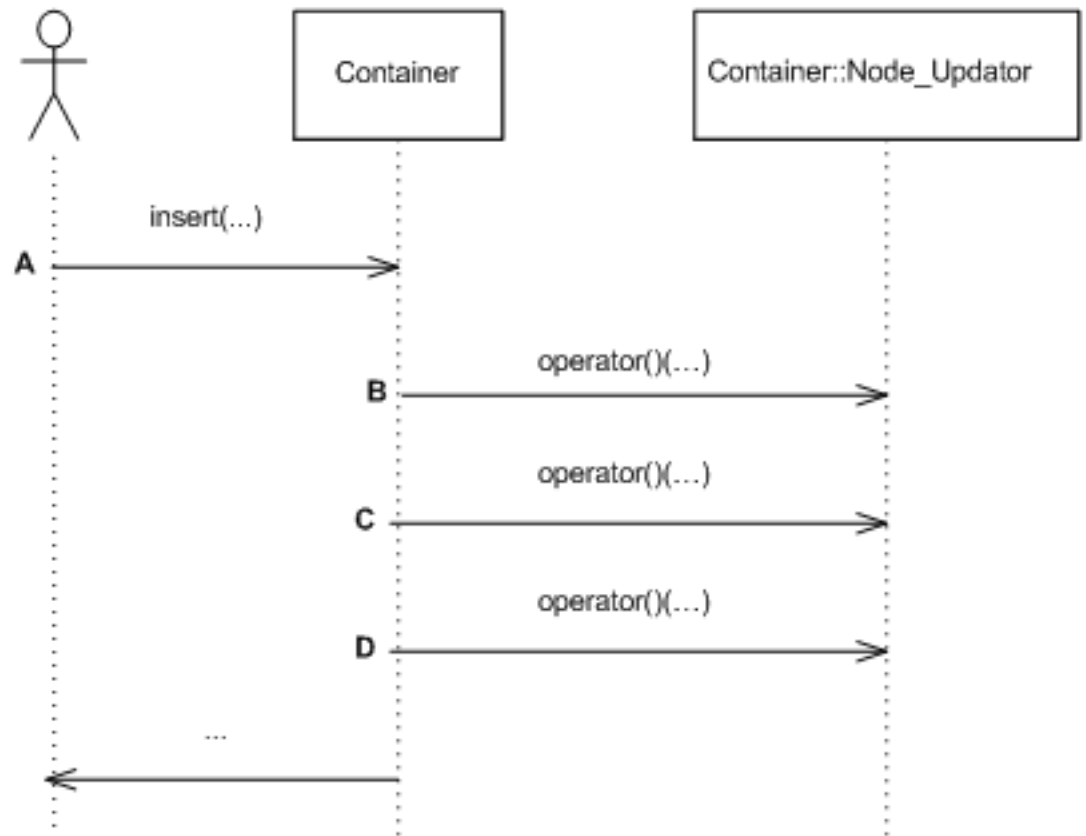

Figure 22.26: Insert update sequence

To complete the description of the scheme, three questions need to be answered:

1. How can a tree which supports order statistics define a method such as `find_by_order`?
2. How can the node updater base access methods of the tree?
3. How can the following cyclic dependency be resolved? `node_update` is a base class of the tree, yet it uses node iterators defined in the tree (its child).

The first two questions are answered by the fact that `node_update` (an instantiation of `Node_Update`) is a *public* base class of the tree. Consequently:

1. Any public methods of `node_update` are automatically methods of the tree ([56]). Thus an order-statistics node updater, `tree_order_statistics_node_update` defines the `find_by_order` method; any tree instantiated by this policy consequently supports this method as well.
2. In C++, if a base class declares a method as `virtual`, it is `virtual` in its subclasses. If `node_update` needs to access one of the tree's methods, say the member function `end`, it simply declares that method as `virtual abstract`.

The cyclic dependency is solved through template-template parameters. `Node_Update` is parametrized by the tree's node iterators, its comparison functor, and its allocator type. Thus, instantiations of `Node_Update` have all information required.

This library assumes that constructing a metadata object and modifying it are exception free. Suppose that during some method, say `insert`, a metadata-related operation (e.g., changing the value of a metadata) throws an exception. Ack! Rolling back the method is unusually complex.

Previously, a distinction was made between redundant policies and null policies. Node invariants show a case where null policies are required.

Assume a regular tree is required, one which need not support order statistics or interval overlap queries. Seemingly, in this case a redundant policy - a policy which doesn't affect nodes' contents would suffice. This, would lead to the following drawbacks:

1. Each node would carry a useless metadata object, wasting space.
2. The tree cannot know if its `Node_Update` policy actually modifies a node's metadata (this is halting reducible). In the graphic below, assume the shaded node is inserted. The tree would have to traverse the useless path shown to the root, applying redundant updates all the way.

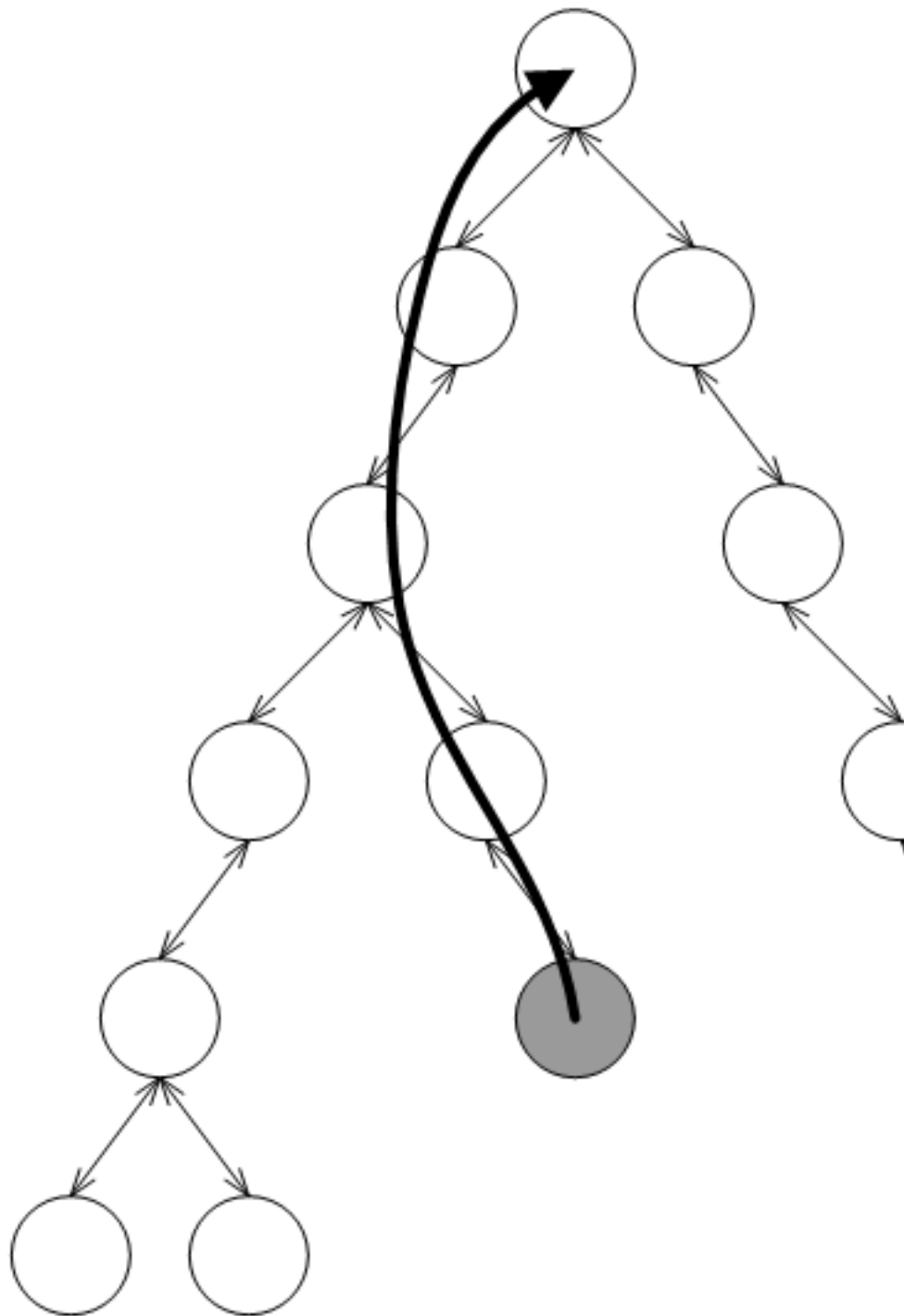

Figure 22.27: Useless update path

A null policy class, `null_node_update` solves both these problems. The tree detects that node invariants are irrelevant, and defines all accordingly.

22.3.2.2.4 Split and Join

Tree-based containers support split and join methods. It is possible to split a tree so that it passes all nodes with keys larger than a given key to a different tree. These methods have the following advantages over the alternative of externally inserting to the destination tree and erasing from the source tree:

1. These methods are efficient - red-black trees are split and joined in poly-logarithmic complexity; ordered-vector trees are split and joined at linear complexity. The alternatives have super-linear complexity.
2. Aside from orders of growth, these operations perform few allocations and de-allocations. For red-black trees, allocations are not performed, and the methods are exception-free.

22.3.2.3 Trie

22.3.2.3.1 Interface

The trie-based container has the following declaration:

```
template<typename Key,
        typename Mapped,
        typename Cmp_Fn = std::less<Key>,
        typename Tag = pat_trie_tag,
        template<typename Const_Node_Iterator,
                typename Node_Iterator,
                typename E_Access_Traits_,
                typename Allocator_>
        class Node_Update = null_node_update,
        typename Allocator = std::allocator<char> >
class trie;
```

The parameters have the following meaning:

1. `Key` is the key type.
2. `Mapped` is the mapped-policy.
3. `E_Access_Traits` is described in below.
4. `Tag` specifies which underlying data structure to use, and is described shortly.
5. `Node_Update` is a policy for updating node invariants. This is described below.
6. `Allocator` is an allocator type.

The `Tag` parameter specifies which underlying data structure to use. Instantiating it by `pat_trie_tag`, specifies an underlying PATRICIA trie (explained shortly); any other tag is currently illegal.

Following is a description of a (PATRICIA) trie (this implementation follows [90] and [69]).

A (PATRICIA) trie is similar to a tree, but with the following differences:

1. It explicitly views keys as a sequence of elements. E.g., a trie can view a string as a sequence of characters; a trie can view a number as a sequence of bits.
2. It is not (necessarily) binary. Each node has fan-out $n + 1$, where n is the number of distinct elements.
3. It stores values only at leaf nodes.
4. Internal nodes have the properties that A) each has at least two children, and B) each shares the same prefix with any of its descendant.

A (PATRICIA) trie has some useful properties:

1. It can be configured to use large node fan-out, giving it very efficient find performance (albeit at insertion complexity and size).
2. It works well for common-prefix keys.
3. It can support efficiently queries such as which keys match a certain prefix. This is sometimes useful in file systems and routers, and for "type-ahead" aka predictive text matching on mobile devices.

22.3.2.3.2 Details

22.3.2.3.2.1 Element Access Traits

A trie inherently views its keys as sequences of elements. For example, a trie can view a string as a sequence of characters. A trie needs to map each of n elements to a number in $\{0, n - 1\}$. For example, a trie can map a character c to

```
static_cast<size_t>(c)
```

.

Seemingly, then, a trie can assume that its keys support (const) iterators, and that the `value_type` of this iterator can be cast to a `size_t`. There are several reasons, though, to decouple the mechanism by which the trie accesses its keys' elements from the trie:

1. In some cases, the numerical value of an element is inappropriate. Consider a trie storing DNA strings. It is logical to use a trie with a fan-out of $5 = 1 + |\{ 'A', 'C', 'G', 'T' \}|$. This requires mapping 'T' to 3, though.
2. In some cases the keys' iterators are different than what is needed. For example, a trie can be used to search for common suffixes, by using strings' `reverse_iterator`. As another example, a trie mapping UNICODE strings would have a huge fan-out if each node would branch on a UNICODE character; instead, one can define an iterator iterating over 8-bit (or less) groups.

trie is, consequently, parametrized by `E_Access_Traits` - traits which instruct how to access sequences' elements. `string_trie_e_access_traits` is a traits class for strings. Each such traits define some types, like:

```
typename E_Access_Traits::const_iterator
```

is a const iterator iterating over a key's elements. The traits class must also define methods for obtaining an iterator to the first and last element of a key.

The graphic below shows a (PATRICIA) trie resulting from inserting the words: "I wish that I could ever see a poem lovely as a trie" (which, unfortunately, does not rhyme).

The leaf nodes contain values; each internal node contains two `typename E_Access_Traits::const_iterator` objects, indicating the maximal common prefix of all keys in the sub-tree. For example, the shaded internal node roots a sub-tree with leafs "a" and "as". The maximal common prefix is "a". The internal node contains, consequently, two const iterators, one pointing to 'a', and the other to 's'.

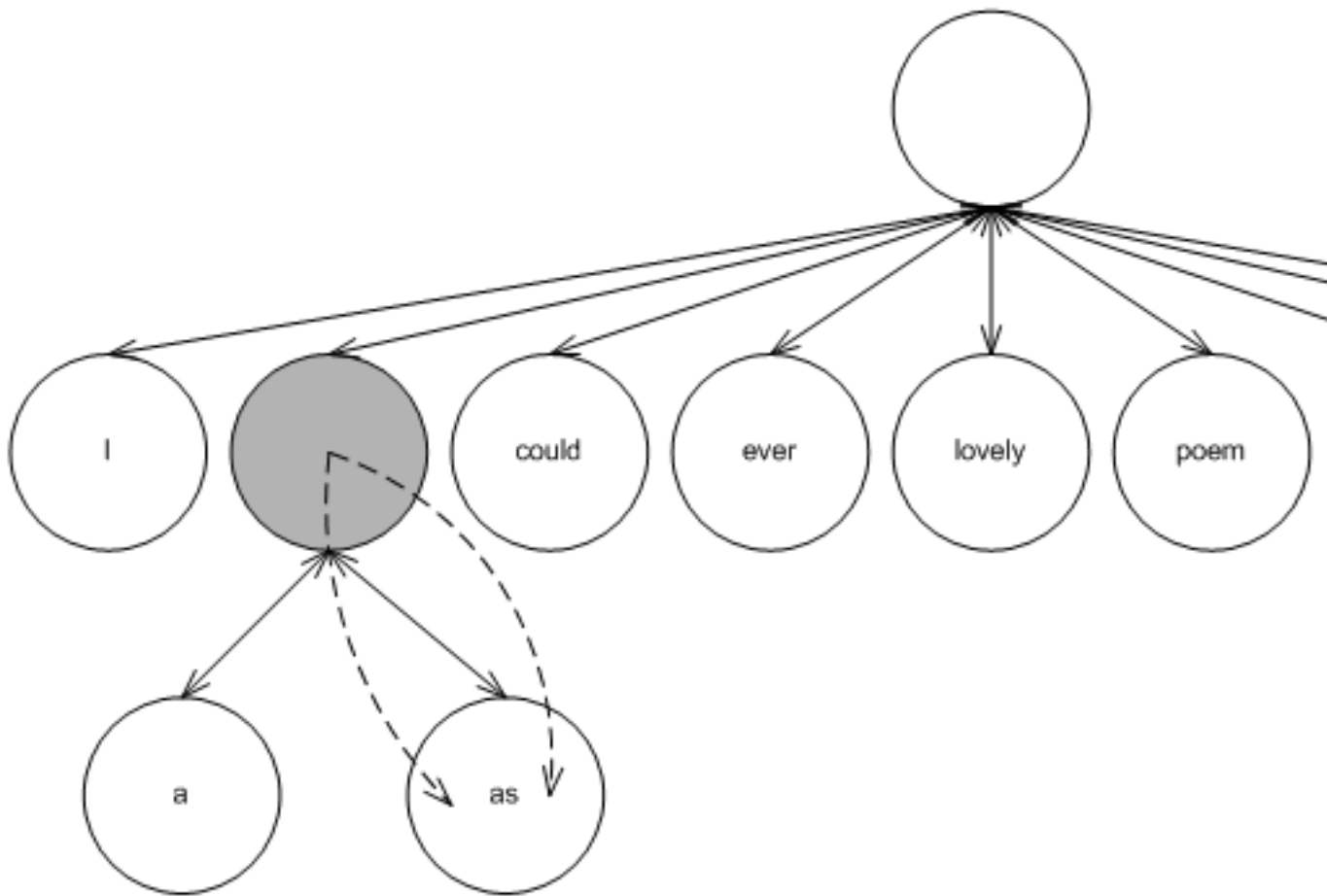

Figure 22.28: A PATRICIA trie

22.3.2.3.2.2 Node Invariants

Trie-based containers support node invariants, as do tree-based containers. There are two minor differences, though, which, unfortunately, thwart sharing them sharing the same node-updating policies:

1. A trie's `Node_Update` template-template parameter is parametrized by `E_Access_Traits`, while a tree's `Node_Update` template-template parameter is parametrized by `Cmp_Fn`.
2. Tree-based containers store values in all nodes, while trie-based containers (at least in this implementation) store values in leafs.

The graphic below shows the scheme, as well as some predefined policies (which are explained below).

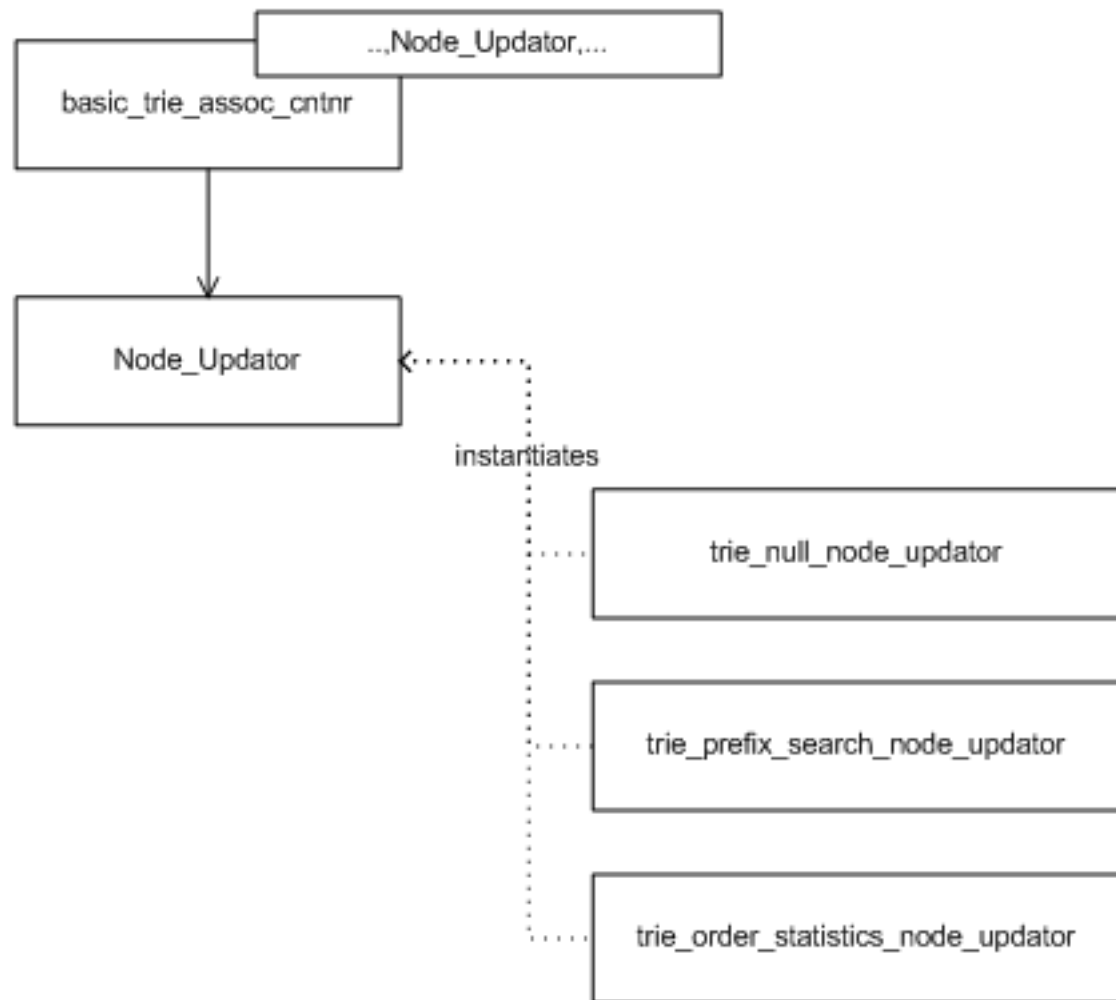

Figure 22.29: A trie and its update policy

This library offers the following pre-defined trie node updating policies:

1. `trie_order_statistics_node_update` supports order statistics.
2. `trie_prefix_search_node_update` supports searching for ranges that match a given prefix.
3. `null_node_update` is the null node updater.

22.3.2.3.2.3 Split and Join

Trie-based containers support split and join methods; the rationale is equal to that of tree-based containers supporting these methods.

22.3.2.4 List

22.3.2.4.1 Interface

The list-based container has the following declaration:

```
template<typename Key,
typename Mapped,
typename Eq_Fn = std::equal_to<Key>,
typename Update_Policy = move_to_front_lu_policy<>,
typename Allocator = std::allocator<char> >
class list_update;
```

The parameters have the following meaning:

1. `Key` is the key type.
2. `Mapped` is the mapped-policy.
3. `Eq_Fn` is a key equivalence functor.
4. `Update_Policy` is a policy updating positions in the list based on access patterns. It is described in the following subsection.
5. `Allocator` is an allocator type.

A list-based associative container is a container that stores elements in a linked-list. It does not order the elements by any particular order related to the keys. List-based containers are primarily useful for creating "multimaps". In fact, list-based containers are designed in this library expressly for this purpose.

List-based containers might also be useful for some rare cases, where a key is encapsulated to the extent that only key-equivalence can be tested. Hash-based containers need to know how to transform a key into a size type, and tree-based containers need to know if some key is larger than another. List-based associative containers, conversely, only need to know if two keys are equivalent.

Since a list-based associative container does not order elements by keys, is it possible to order the list in some useful manner? Remarkably, many on-line competitive algorithms exist for reordering lists to reflect access prediction. (See [85] and [57]).

22.3.2.4.2 Details

22.3.2.4.2.1 Underlying Data Structure

The graphic below shows a simple list of integer keys. If we search for the integer 6, we are paying an overhead: the link with key 6 is only the fifth link; if it were the first link, it could be accessed faster.

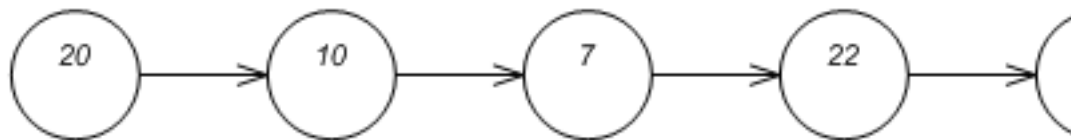

Figure 22.30: A simple list

List-update algorithms reorder lists as elements are accessed. They try to determine, by the access history, which keys to move to the front of the list. Some of these algorithms require adding some metadata alongside each entry.

For example, in the graphic below label A shows the counter algorithm. Each node contains both a key and a count metadata (shown in bold). When an element is accessed (e.g. 6) its count is incremented, as shown in label B. If the count reaches some predetermined value, say 10, as shown in label C, the count is set to 0 and the node is moved to the front of the list, as in label D.

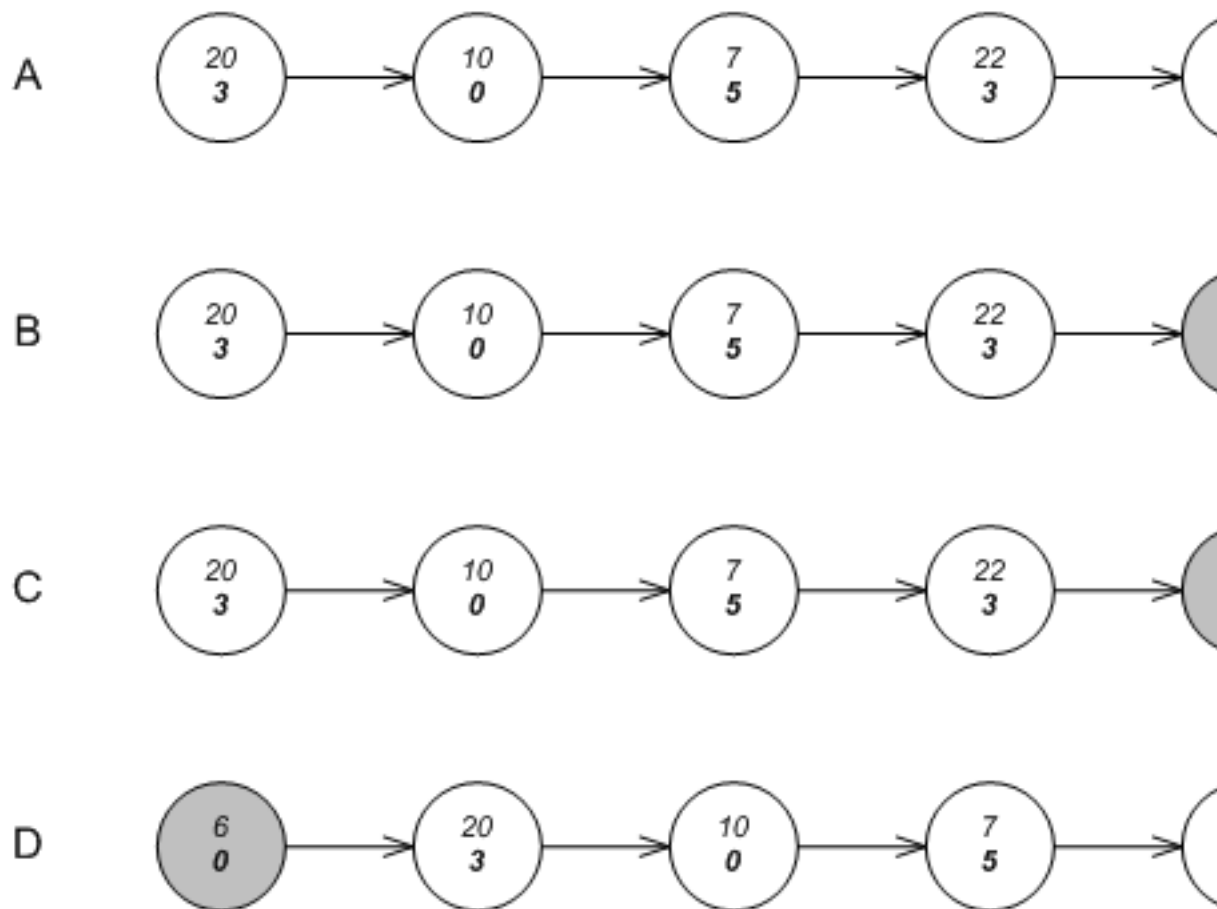

Figure 22.31: The counter algorithm

22.3.2.4.2.2 Policies

this library allows instantiating lists with policies implementing any algorithm moving nodes to the front of the list (policies implementing algorithms interchanging nodes are unsupported).

Associative containers based on lists are parametrized by a `Update_Policy` parameter. This parameter defines the type of metadata each node contains, how to create the metadata, and how to decide, using this metadata, whether to move a node to the front of the list. A list-based associative container object derives (publicly) from its update policy.

An instantiation of `Update_Policy` must define internally `update_metadata` as the metadata it requires. Internally, each node of the list contains, besides the usual key and data, an instance of `typename Update_Policy::update_metadata`.

An instantiation of `Update_Policy` must define internally two operators:

```
update_metadata
operator() ();

bool
operator() (update_metadata &);
```

The first is called by the container object, when creating a new node, to create the node's metadata. The second is called by the container object, when a node is accessed (when a find operation's key is equivalent to the key of the node), to determine whether to move the node to the front of the list.

The library contains two predefined implementations of list-update policies. The first is `lu_counter_policy`, which implements the counter algorithm described above. The second is `lu_move_to_front_policy`, which unconditionally move an accessed element to the front of the list. The latter type is very useful in this library, since there is no need to associate metadata with each element. (See [57])

22.3.2.4.2.3 Use in Multimaps

In this library, there are no equivalents for the standard's multimaps and multisets; instead one uses an associative container mapping primary keys to secondary keys.

List-based containers are especially useful as associative containers for secondary keys. In fact, they are implemented here expressly for this purpose.

To begin with, these containers use very little per-entry structure memory overhead, since they can be implemented as singly-linked lists. (Arrays use even lower per-entry memory overhead, but they are less flexible in moving around entries, and have weaker invalidation guarantees).

More importantly, though, list-based containers use very little per-container memory overhead. The memory overhead of an empty list-based container is practically that of a pointer. This is important for when they are used as secondary associative-containers in situations where the average ratio of secondary keys to primary keys is low (or even 1).

In order to reduce the per-container memory overhead as much as possible, they are implemented as closely as possible to singly-linked lists.

1. List-based containers do not store internally the number of values that they hold. This means that their `size` method has linear complexity (just like `std::list`). Note that finding the number of equivalent-key values in a standard multimap also has linear complexity (because it must be done, via `std::distance` of the multimap's `equal_range` method), but usually with higher constants.
2. Most associative-container objects each hold a policy object (a hash-based container object holds a hash functor). List-based containers, conversely, only have class-wide policy objects.

22.3.2.5 Priority Queue

22.3.2.5.1 Interface

The priority queue container has the following declaration:

```
template<typename Value_Type,  
        typename Cmp_Fn = std::less<Value_Type>,  
        typename Tag = pairing_heap_tag,  
        typename Allocator = std::allocator<char > >  
class priority_queue;
```

The parameters have the following meaning:

1. `Value_Type` is the value type.
2. `Cmp_Fn` is a value comparison functor
3. `Tag` specifies which underlying data structure to use.
4. `Allocator` is an allocator type.

The `Tag` parameter specifies which underlying data structure to use. Instantiating it by `pairing_heap_tag`, `binary_heap_tag`, `binomial_heap_tag`, `rc_binomial_heap_tag`, or `thin_heap_tag`, specifies, respectively, an underlying pairing heap ([70]), binary heap ([66]), binomial heap ([66]), a binomial heap with a redundant binary counter ([80]), or a thin heap ([75]).

As mentioned in the tutorial, `__gnu_pbds::priority_queue` shares most of the same interface with `std::priority_queue`. E.g. if `q` is a priority queue of type `Q`, then `q.top()` will return the "largest" value in the container (according to `typename Q::cmp_fn`). `__gnu_pbds::priority_queue` has a larger (and very slightly different) interface than `std::priority_queue`, however, since typically `push` and `pop` are deemed insufficient for manipulating priority-queues.

Different settings require different priority-queue implementations which are described in later; see traits discusses ways to differentiate between the different traits of different implementations.

22.3.2.5.2 Details

22.3.2.5.2.1 Iterators

There are many different underlying-data structures for implementing priority queues. Unfortunately, most such structures are oriented towards making `push` and `top` efficient, and consequently don't allow efficient access of other elements: for instance, they cannot support an efficient `find` method. In the use case where it is important to both access and "do something with" an arbitrary value, one would be out of luck. For example, many graph algorithms require modifying a value (typically increasing it in the sense of the priority queue's comparison functor).

In order to access and manipulate an arbitrary value in a priority queue, one needs to reference the internals of the priority queue from some form of an associative container - this is unavoidable. Of course, in order to maintain the encapsulation of the priority queue, this needs to be done in a way that minimizes exposure to implementation internals.

In this library the priority queue's `insert` method returns an iterator, which if valid can be used for subsequent `modify` and `erase` operations. This both preserves the priority queue's encapsulation, and allows accessing arbitrary values (since the returned iterators from the `push` operation can be stored in some form of associative container).

Priority queues' iterators present a problem regarding their invalidation guarantees. One assumes that calling `operator++` on an iterator will associate it with the "next" value. Priority-queues are self-organizing: each operation changes what the "next" value means. Consequently, it does not make sense that `push` will return an iterator that can be incremented - this can have no possible use. Also, as in the case of hash-based containers, it is awkward to define if a subsequent `push` operation invalidates a prior returned iterator: it invalidates it in the sense that its "next" value is not related to what it previously considered to be its "next" value. However, it might not invalidate it, in the sense that it can be de-referenced and used for `modify` and `erase` operations.

Similarly to the case of the other unordered associative containers, this library uses a distinction between point-type and range type iterators. A priority queue's iterator can always be converted to a `point_iterator`, and a `const_iterator` can always be converted to a `point_const_iterator`.

The following snippet demonstrates manipulating an arbitrary value:

```
// A priority queue of integers.
priority_queue<int > p;

// Insert some values into the priority queue.
priority_queue<int >::point_iterator it = p.push(0);

p.push(1);
p.push(2);

// Now modify a value.
p.modify(it, 3);

assert(p.top() == 3);
```

It should be noted that an alternative design could embed an associative container in a priority queue. Could, but most probably should not. To begin with, it should be noted that one could always encapsulate a priority queue and an associative container

mapping values to priority queue iterators with no performance loss. One cannot, however, "un-encapsulate" a priority queue embedding an associative container, which might lead to performance loss. Assume, that one needs to associate each value with some data unrelated to priority queues. Then using this library's design, one could use an associative container mapping each value to a pair consisting of this data and a priority queue's iterator. Using the embedded method would need to use two associative containers. Similar problems might arise in cases where a value can reside simultaneously in many priority queues.

22.3.2.5.2.2 Underlying Data Structure

There are three main implementations of priority queues: the first employs a binary heap, typically one which uses a sequence; the second uses a tree (or forest of trees), which is typically less structured than an associative container's tree; the third simply uses an associative container. These are shown in the graphic below, in labels A1 and A2, label B, and label C.

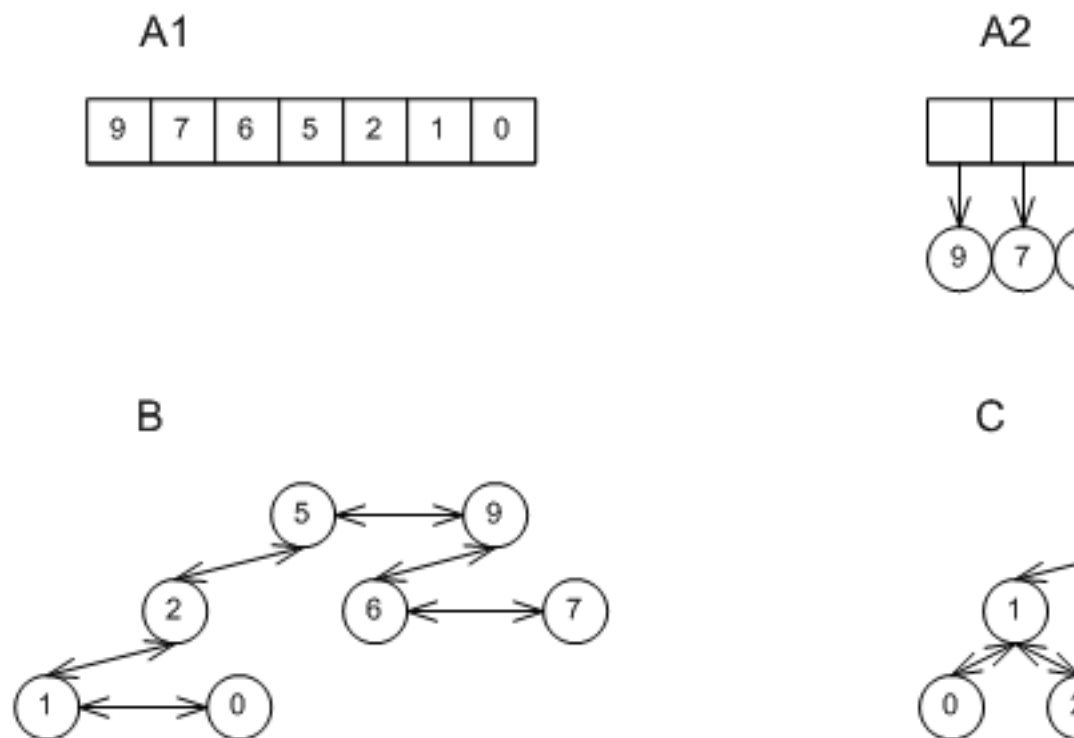

Figure 22.32: Underlying Priority-Queue Data-Structures.

Roughly speaking, any value that is both pushed and popped from a priority queue must incur a logarithmic expense (in the amortized sense). Any priority queue implementation that would avoid this, would violate known bounds on comparison-based sorting (see [66] and [64]).

Most implementations do not differ in the asymptotic amortized complexity of `push` and `pop` operations, but they differ in the constants involved, in the complexity of other operations (e.g., `modify`), and in the worst-case complexity of single operations. In general, the more "structured" an implementation (i.e., the more internal invariants it possesses) - the higher its amortized complexity of `push` and `pop` operations.

This library implements different algorithms using a single class: `priority_queue`. Instantiating the `Tag` template parameter, "selects" the implementation:

1. Instantiating `Tag =binary_heap_tag` creates a binary heap of the form in represented in the graphic with labels A1 or A2. The former is internally selected by `priority_queue` if `Value_Type` is instantiated by a primitive type (e.g., an `int`);

the latter is internally selected for all other types (e.g., `std::string`). This implementation is relatively unstructured, and so has good `push` and `pop` performance; it is the "best-in-kind" for primitive types, e.g., ints. Conversely, it has high worst-case performance, and can support only linear-time `modify` and `erase` operations.

2. Instantiating `Tag =pairing_heap_tag` creates a pairing heap of the form represented by label B in the graphic above. This implementation too is relatively unstructured, and so has good `push` and `pop` performance; it is the "best-in-kind" for non-primitive types, e.g., `std::strings`. It also has very good worst-case `push` and `join` performance ($O(1)$), but has high worst-case `pop` complexity.
3. Instantiating `Tag =binomial_heap_tag` creates a binomial heap of the form represented by label B in the graphic above. This implementation is more structured than a pairing heap, and so has worse `push` and `pop` performance. Conversely, it has sub-linear worst-case bounds for `pop`, e.g., and so it might be preferred in cases where responsiveness is important.
4. Instantiating `Tag =rc_binomial_heap_tag` creates a binomial heap of the form represented in label B above, accompanied by a redundant counter which governs the trees. This implementation is therefore more structured than a binomial heap, and so has worse `push` and `pop` performance. Conversely, it guarantees $O(1)$ `push` complexity, and so it might be preferred in cases where the responsiveness of a binomial heap is insufficient.
5. Instantiating `Tag =thin_heap_tag` creates a thin heap of the form represented by the label B in the graphic above. This implementation too is more structured than a pairing heap, and so has worse `push` and `pop` performance. Conversely, it has better worst-case and identical amortized complexities than a Fibonacci heap, and so might be more appropriate for some graph algorithms.

Of course, one can use any order-preserving associative container as a priority queue, as in the graphic above label C, possibly by creating an adapter class over the associative container (much as `std::priority_queue` can adapt `std::vector`). This has the advantage that no cross-referencing is necessary at all; the priority queue itself is an associative container. Most associative containers are too structured to compete with priority queues in terms of `push` and `pop` performance.

22.3.2.5.2.3 Traits

It would be nice if all priority queues could share exactly the same behavior regardless of implementation. Sadly, this is not possible. Just one for instance is in `join` operations: joining two binary heaps might throw an exception (not corrupt any of the heaps on which it operates), but joining two pairing heaps is exception free.

Tags and traits are very useful for manipulating generic types. `__gnu_pbds::priority_queue` publicly defines `container_category` as one of the tags. Given any container `Cntnr`, the tag of the underlying data structure can be found via `typename Cntnr::container_category`; this is one of the possible tags shown in the graphic below.

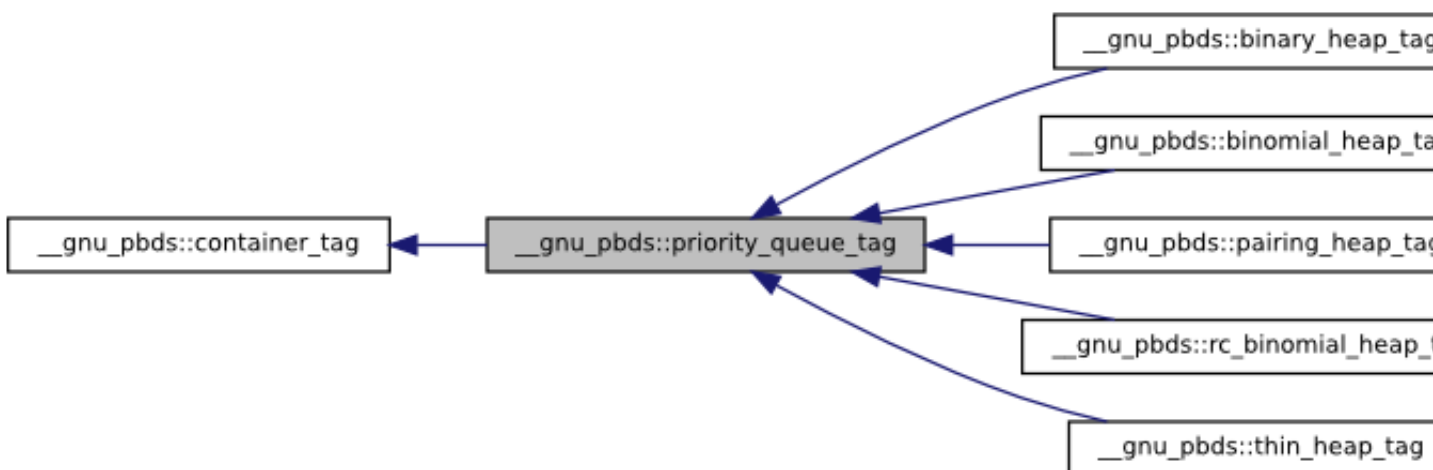

Figure 22.33: Priority-Queue Data-Structure Tags.

Additionally, a traits mechanism can be used to query a container type for its attributes. Given any container `Cntnr`, then

```
__gnu_pbds::container_traits<Cntnr>
```

is a traits class identifying the properties of the container.

To find if a container might throw if two of its objects are joined, one can use

```
container_traits<Cntnr>::split_join_can_throw
```

Different priority-queue implementations have different invalidation guarantees. This is especially important, since there is no way to access an arbitrary value of priority queues except for iterators. Similarly to associative containers, one can use

```
container_traits<Cntnr>::invalidation_guarantee
```

to get the invalidation guarantee type of a priority queue.

It is easy to understand from the graphic above, what `container_traits<Cntnr>::invalidation_guarantee` will be for different implementations. All implementations of type represented by label B have `point_invalidation_guarantee`: the container can freely internally reorganize the nodes - range-type iterators are invalidated, but point-type iterators are always valid. Implementations of type represented by labels A1 and A2 have `basic_invalidation_guarantee`: the container can freely internally reallocate the array - both point-type and range-type iterators might be invalidated.

This has major implications, and constitutes a good reason to avoid using binary heaps. A binary heap can perform `modify` or `erase` efficiently given a valid point-type iterator. However, in order to supply it with a valid point-type iterator, one needs to iterate (linearly) over all values, then supply the relevant iterator (recall that a range-type iterator can always be converted to a point-type iterator). This means that if the number of `modify` or `erase` operations is non-negligible (say super-logarithmic in the total sequence of operations) - binary heaps will perform badly.

22.4 Testing

22.4.1 Regression

The library contains a single comprehensive regression test. For a given container type in this library, the test creates an object of the container type and an object of the corresponding standard type (e.g., `std::set`). It then performs a random sequence of methods with random arguments (e.g., inserts, erases, and so forth) on both objects. At each operation, the test checks the return value of the method, and optionally both compares this library's object with the standard's object as well as performing other consistency checks on this library's object (e.g., order preservation, when applicable, or node invariants, when applicable).

Additionally, the test integrally checks exception safety and resource leaks. This is done as follows. A special allocator type, written for the purpose of the test, both randomly throws an exceptions when allocations are performed, and tracks allocations and de-allocations. The exceptions thrown at allocations simulate memory-allocation failures; the tracking mechanism checks for memory-related bugs (e.g., resource leaks and multiple de-allocations). Both this library's containers and the containers' value-types are configured to use this allocator.

For granularity, the test is split into the several sources, each checking only some containers.

For more details, consult the files in `testsuite/ext/pb_ds/regression`.

22.4.2 Performance

22.4.2.1 Hash-Based

22.4.2.1.1 Text `find`

22.4.2.1.1.1 Description

This test inserts a number of values with keys from an arbitrary text ([98]) into a container, then performs a series of finds using `find`. It measures the average time for `find` as a function of the number of values inserted.

It uses the test file: `performance/ext/pb_ds/text_find_timing_test.cc`

And uses the data file: `filethirty_years_among_the_dead_preproc.txt`

The test checks the effect of different range-hashing functions, trigger policies, and cache-hashing policies.

22.4.2.1.1.2 Results

The graphic below show the results for the native and collision-chaining hash types the the function applied being a text find timing test using `find`.

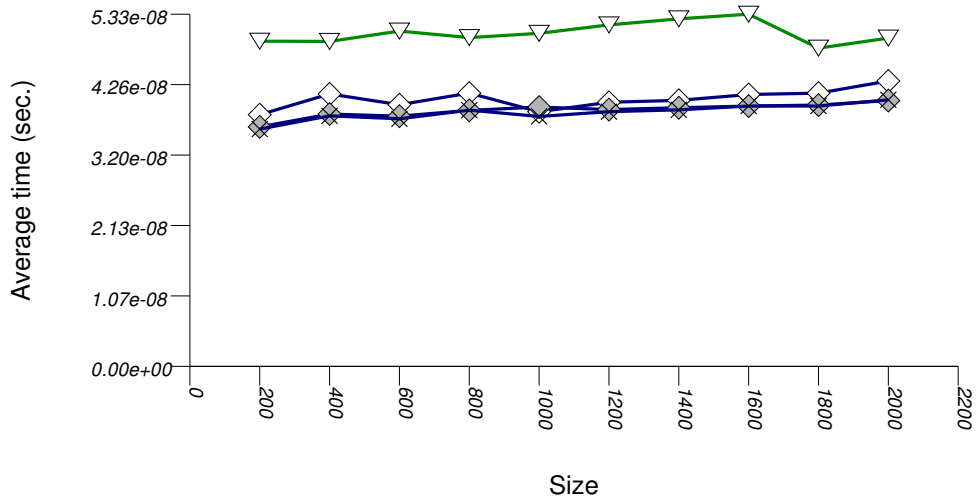

- ▽ cc_hash_mod_prime_nea_lc_1div8_1div1_nsth_map
- ◇ cc_hash_mask_exp_nea_lc_1div8_1div1_nsth_map
- ◆ cc_hash_mask_exp_nea_lc_1div8_1div2_sth_map
- × cc_hash_mask_exp_nea_lc_1div8_1div2_nsth_map

The abbreviated names in the legend of the graphic above are instantiated with the types in the following table.

<i>Name/Instantiating Type</i>	<i>Parameter</i>	<i>Details</i>	<i>Parameter</i>	<i>Details</i>
n_hash_map_ncah				
<code>std::tr1::unordered_map</code>	<code>cache_hash_code</code>	<code>false</code>		
cc_hash_mod_prime_1div1_nsth_map				
<code>cc_hash_table</code>	<code>Comb_Hash_Fn</code>	<code>direct_mod_range_hashing</code>		
	<code>Resize_Policy</code>	<code>hash_standard_resize_policy</code>	<code>Size_Policy</code>	<code>hash_prime_size_policy</code>
			<code>Trigger_Policy</code>	<code>hash_load_check_resize_trigger with $\alpha_{\min} = 1/8$ and $\alpha_{\max} = 1/1$</code>
cc_hash_mask_exp_1div2_sth_map				
<code>cc_hash_table</code>	<code>Comb_Hash_Fn</code>	<code>direct_mask_range_hashing</code>		
	<code>Resize_Policy</code>	<code>hash_standard_resize_policy</code>	<code>Size_Policy</code>	<code>hash_exponential_size_policy</code>

<i>Name/Instantiating Type</i>	<i>Parameter</i>	<i>Details</i>	<i>Parameter</i>	<i>Details</i>
			Trigger_Policy	hash_load_checker with $\alpha_{\min} = 1/8$ and $\alpha_{\max} = 1/2$
cc_hash_mask_exp_ldiv1_nsth_map				
cc_hash_table	Comb_Hash_Fn	direct_mask_range_hashing		
	Resize_Policy	hash_standard_resize_policy	Size_Policy	hash_exponential_size_policy
Trigger_Policy			hash_load_checker with $\alpha_{\min} = 1/8$ and $\alpha_{\max} = 1/1$	
cc_hash_mask_exp_ldiv2_nsth_map				
cc_hash_table	Comb_Hash_Fn	direct_mask_range_hashing		
	Resize_Policy	hash_standard_resize_policy	Size_Policy	hash_exponential_size_policy
Trigger_Policy			hash_load_checker with $\alpha_{\min} = 1/8$ and $\alpha_{\max} = 1/2$	

22.4.2.1.1.3 Observations

In this setting, the range-hashing scheme affects performance more than other policies. As the results show, containers using mod-based range-hashing (including the native hash-based container, which is currently hard-wired to this scheme) have lower performance than those using mask-based range-hashing. A modulo-based range-hashing scheme's main benefit is that it takes into account all hash-value bits. Standard string hash-functions are designed to create hash values that are nearly-uniform as is ([77]).

Trigger policies, i.e. the load-checks constants, affect performance to a lesser extent.

Perhaps surprisingly, storing the hash value alongside each entry affects performance only marginally, at least in this library's implementation. (Unfortunately, it was not possible to run the tests with `std::tr1::unordered_map`'s `cache_hash_code = true`, as it appeared to malfunction.)

22.4.2.1.2 Integer find

22.4.2.1.2.1 Description

This test inserts a number of values with uniform integer keys into a container, then performs a series of finds using `find`. It measures the average time for `find` as a function of the number of values inserted.

It uses the test file: `performance/ext/pb_ds/random_int_find_timing.cc`

The test checks the effect of different underlying hash-tables, range-hashing functions, and trigger policies.

22.4.2.1.2.2 Results

There are two sets of results for this type, one for collision-chaining hashes, and one for general-probe hashes.

The first graphic below shows the results for the native and collision-chaining hash types. The function applied being a random integer timing test using `find`.

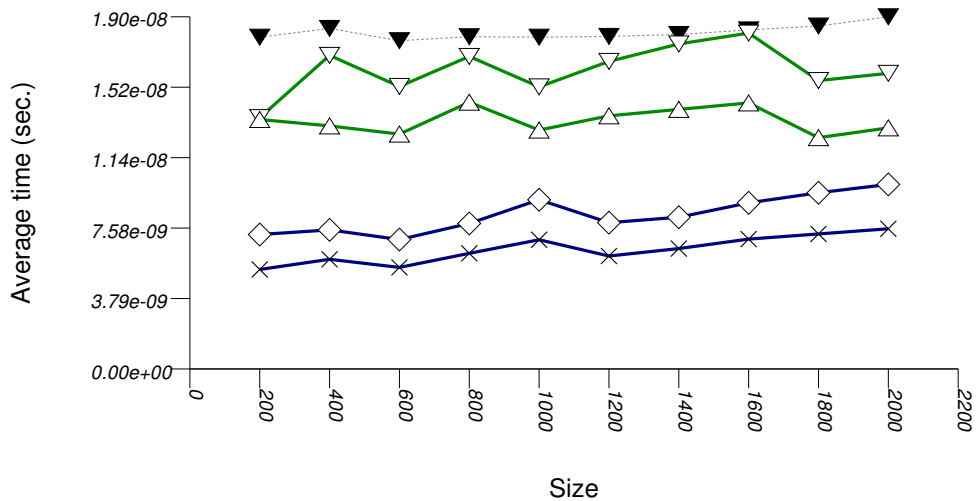

- ▼ n_hash_map_ncah
- ▽ cc_hash_mod_prime_nea_lc_1div8_1div1_nsth_map
- △ cc_hash_mod_prime_nea_lc_1div8_1div2_nsth_map
- ◇ cc_hash_mask_exp_nea_lc_1div8_1div1_nsth_map
- × cc_hash_mask_exp_nea_lc_1div8_1div2_nsth_map

The abbreviated names in the legend of the graphic above are instantiated with the types in the following table.

Name/Instantiating Type	Parameter	Details	Parameter	Details
n_hash_map_ncah				
std::tr1::unordered_map	cache_hash_code	false		
cc_hash_mod_prime_1div1_nsth_map				
cc_hash_table	Comb_Hash_Fn	direct_mod_range_hashing		
	Resize_Policy	hash_standard_resize_policy	Size_Policy	hash_prime_size_policy
			Trigger_Policy	hash_load_check_resize_trigger with $\alpha_{\min} = 1/8$ and $\alpha_{\max} = 1/1$
cc_hash_mod_prime_1div2_nsth_map				
cc_hash_table	Comb_Hash_Fn	direct_mod_range_hashing		
	Resize_Policy	hash_standard_resize_policy	Size_Policy	hash_prime_size_policy
			Trigger_Policy	hash_load_check_resize_trigger with $\alpha_{\min} = 1/8$ and $\alpha_{\max} = 1/2$
cc_hash_mask_exp_1div1_nsth_map				
cc_hash_table	Comb_Hash_Fn	direct_mask_range_hashing		
	Resize_Policy	hash_standard_resize_policy	Size_Policy	hash_exponential_size_policy

<i>Name/Instantiating Type</i>	<i>Parameter</i>	<i>Details</i>	<i>Parameter</i>	<i>Details</i>
			Trigger_Policy	hash_load_checker with $\alpha_{\min} = 1/8$ and $\alpha_{\max} = 1/1$
cc_hash_mask_exp_1div2_nsth_map				
cc_hash_table	Comb_Hash_Fn	direct_mask_range_hashing		
	Resize_Policy	hash_standard_resize_policy	Size_Policy	hash_exponential_size_policy
			Trigger_Policy	hash_load_checker with $\alpha_{\min} = 1/8$ and $\alpha_{\max} = 1/2$

And the second graphic shows the results for the native and general-probe hash types. The function applied being a random integer timing test using find.

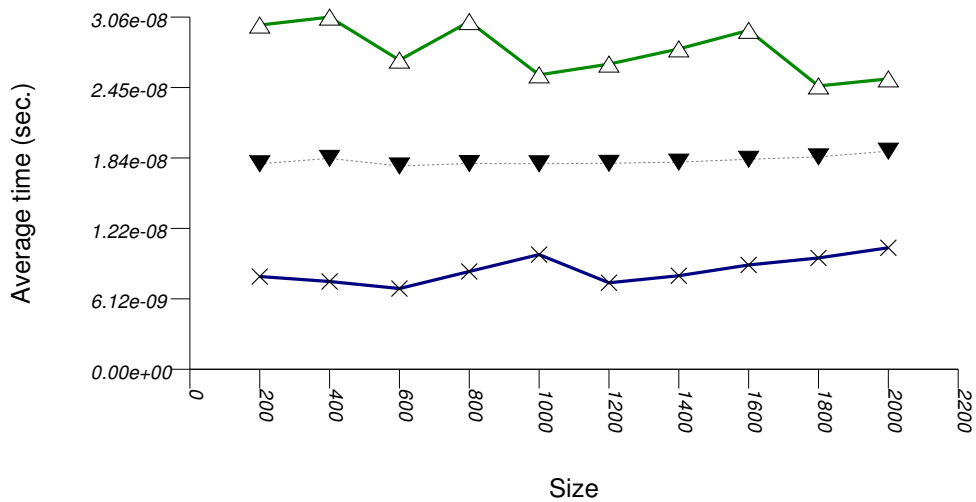

- △gp_hash_mod_quadp_prime_nea_lc_1div8_1div2_nsth_map
- ▼n_hash_map_ncah
- ×gp_hash_mask_linp_exp_nea_lc_1div8_1div2_nsth_map

The abbreviated names in the legend of the graphic above are instantiated with the types in the following table.

<i>Name/Instantiating Type</i>	<i>Parameter</i>	<i>Details</i>	<i>Parameter</i>	<i>Details</i>
n_hash_map_ncah				
std::tr1::unordered_map	cache_hash_code	false		
gp_hash_mod_quadp_prime_1div2_nsth_map				
gp_hash_table	Comb_Hash_Fn	direct_mod_range_hashing		
	Probe_Fn	quadratic_probe_fn		

<i>Name/Instantiating Type</i>	<i>Parameter</i>	<i>Details</i>	<i>Parameter</i>	<i>Details</i>
	Resize_Policy	hash_standard_resize_policy	Size_Policy	hash_prime_size_policy
			Trigger_Policy	hash_load_checker with $\alpha_{\min} = 1/8$ and $\alpha_{\max} = 1/2$
gp_hash_mask_linp_exp_1div2_nsth_map				
gp_hash_table	Comb_Hash_Fn	direct_mask_range_hashing		
	Probe_Fn	linear_probe_fn		
	Resize_Policy	hash_standard_resize_policy	Size_Policy	hash_exponential_size_policy
			Trigger_Policy	hash_load_checker with $\alpha_{\min} = 1/8$ and $\alpha_{\max} = 1/2$

22.4.2.1.2.3 Observations

In this setting, the choice of underlying hash-table affects performance most, then the range-hashing scheme and, only finally, other policies.

When comparing probing and chaining containers, it is apparent that the probing containers are less efficient than the collision-chaining containers (`std::tr1::unordered_map` uses collision-chaining) in this case.

Hash-Based Integer Subscript Insert Timing Test shows a different case, where the situation is reversed;

Within each type of hash-table, the range-hashing scheme affects performance more than other policies; Hash-Based Text `find` Find Timing Test also shows this. In the above graphics should be noted that `std::tr1::unordered_map` are hard-wired currently to mod-based schemes.

22.4.2.1.3 Integer Subscript `find`

22.4.2.1.3.1 Description

This test inserts a number of values with uniform integer keys into a container, then performs a series of finds using `operator[]`. It measures the average time for `operator[]` as a function of the number of values inserted.

It uses the test file: `performance/ext/pb_ds/random_int_subscript_find_timing.cc`

The test checks the effect of different underlying hash-tables, range-hashing functions, and trigger policies.

22.4.2.1.3.2 Results

There are two sets of results for this type, one for collision-chaining hashes, and one for general-probe hashes.

The first graphic below shows the results for the native and collision-chaining hash types, using as the function applied an integer subscript timing test with `find`.

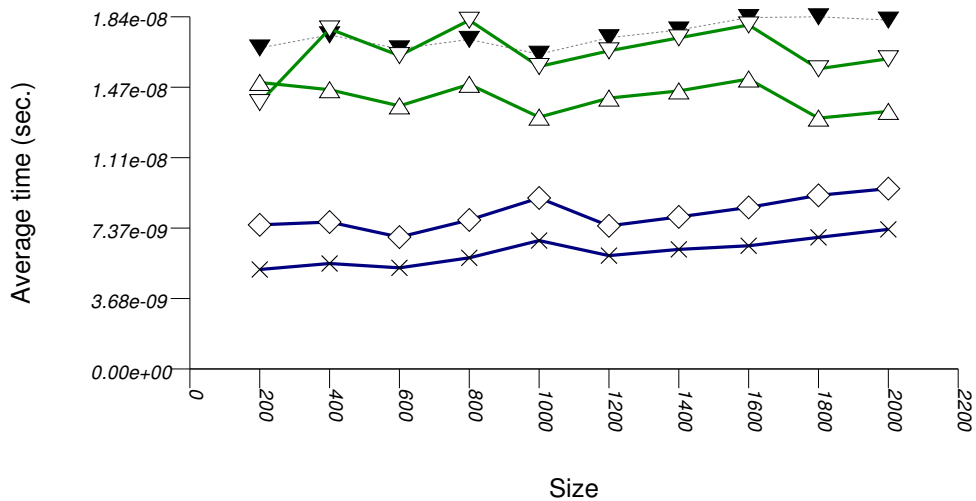

- ▼ n_hash_map_ncah
- ▽ cc_hash_mod_prime_nea_lc_1div8_1div1_nsth_map
- △ cc_hash_mod_prime_nea_lc_1div8_1div2_nsth_map
- ◇ cc_hash_mask_exp_nea_lc_1div8_1div1_nsth_map
- × cc_hash_mask_exp_nea_lc_1div8_1div2_nsth_map

The abbreviated names in the legend of the graphic above are instantiated with the types in the following table.

Name/Instantiating Type	Parameter	Details	Parameter	Details
n_hash_map_ncah				
std::tr1::unordered_map	cache_hash_code	false		
cc_hash_mod_prime_1div1_nsth_map				
cc_hash_table	Comb_Hash_Fn	direct_mod_range_hashing		
	Resize_Policy	hash_standard_resize_policy	Size_Policy	hash_prime_size_policy
			Trigger_Policy	hash_load_check_resize_trigger with $\alpha_{\min} = 1/8$ and $\alpha_{\max} = 1/1$
cc_hash_mod_prime_1div2_nsth_map				
cc_hash_table	Comb_Hash_Fn	direct_mod_range_hashing		
	Resize_Policy	hash_standard_resize_policy	Size_Policy	hash_prime_size_policy
			Trigger_Policy	hash_load_check_resize_trigger with $\alpha_{\min} = 1/8$ and $\alpha_{\max} = 1/2$
cc_hash_mask_exp_1div1_nsth_map				
cc_hash_table	Comb_Hash_Fn	direct_mask_range_hashing		
	Resize_Policy	hash_standard_resize_policy	Size_Policy	hash_exponential_size_policy

<i>Name/Instantiating Type</i>	<i>Parameter</i>	<i>Details</i>	<i>Parameter</i>	<i>Details</i>
			Trigger_Policy	hash_load_checker with $\alpha_{\min} = 1/8$ and $\alpha_{\max} = 1/1$
cc_hash_mask_exp_1div2_nsth_map				
cc_hash_table	Comb_Hash_Fn	direct_mask_range_hashing		
	Resize_Policy	hash_standard_resize_policy	Size_Policy	hash_exponential_size_policy
			Trigger_Policy	hash_load_checker with $\alpha_{\min} = 1/8$ and $\alpha_{\max} = 1/2$

And the second graphic shows the results for the native and general-probe hash types. The function applied being a random integer timing test using find.

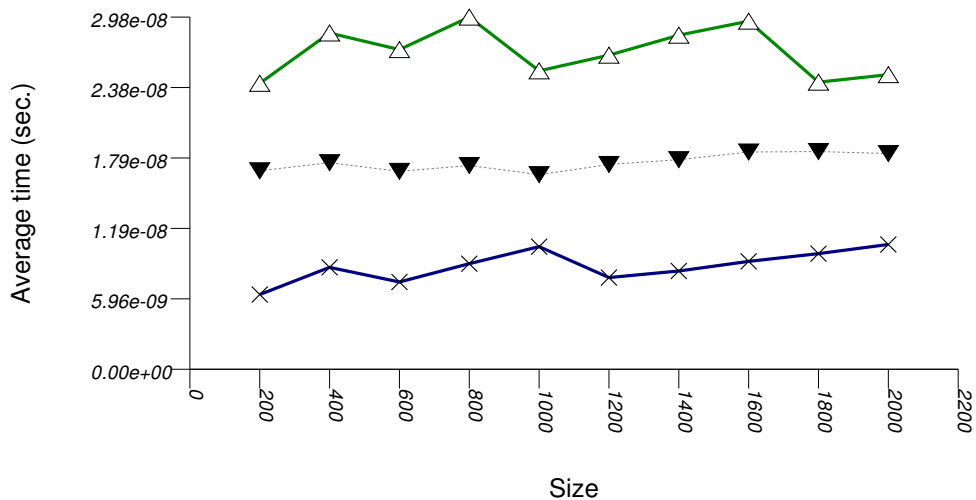

- △gp_hash_mod_quadp_prime_nea_lc_1div8_1div2_nsth_map
- ▼n_hash_map_ncah
- ×gp_hash_mask_linp_exp_nea_lc_1div8_1div2_nsth_map

The abbreviated names in the legend of the graphic above are instantiated with the types in the following table.

<i>Name/Instantiating Type</i>	<i>Parameter</i>	<i>Details</i>	<i>Parameter</i>	<i>Details</i>
n_hash_map_ncah				
std::tr1::unordered_map	cache_hash_code	false		
gp_hash_mod_quadp_prime_1div2_nsth_map				
gp_hash_table	Comb_Hash_Fn	direct_mod_range_hashing		
	Probe_Fn	quadratic_probe_fn		

<i>Name/Instantiating Type</i>	<i>Parameter</i>	<i>Details</i>	<i>Parameter</i>	<i>Details</i>
	Resize_Policy	hash_standard_resize_policy	Size_Policy	hash_prime_size_policy
			Trigger_Policy	hash_load_checker with $\alpha_{\min} = 1/8$ and $\alpha_{\max} = 1/2$
gp_hash_mask_linp_exp_1div2_nsth_map				
gp_hash_table	Comb_Hash_Fn	direct_mask_range_hashing		
	Probe_Fn	linear_probe_fn		
	Resize_Policy	hash_standard_resize_policy	Size_Policy	hash_exponential_size_policy
			Trigger_Policy	hash_load_checker with $\alpha_{\min} = 1/8$ and $\alpha_{\max} = 1/2$

22.4.2.1.3.3 Observations

This test shows similar results to Hash-Based Integer `find` Find Timing test.

22.4.2.1.4 Integer Subscript `insert`

22.4.2.1.4.1 Description

This test inserts a number of values with uniform i.i.d. integer keys into a container, using `operator[]`. It measures the average time for `operator[]` as a function of the number of values inserted.

It uses the test file: `performance/ext/pb_ds/random_int_subscript_insert_timing.cc`

The test checks the effect of different underlying hash-tables.

22.4.2.1.4.2 Results

There are two sets of results for this type, one for collision-chaining hashes, and one for general-probe hashes.

The first graphic below shows the results for the native and collision-chaining hash types, using as the function applied an integer subscript timing test with `insert`.

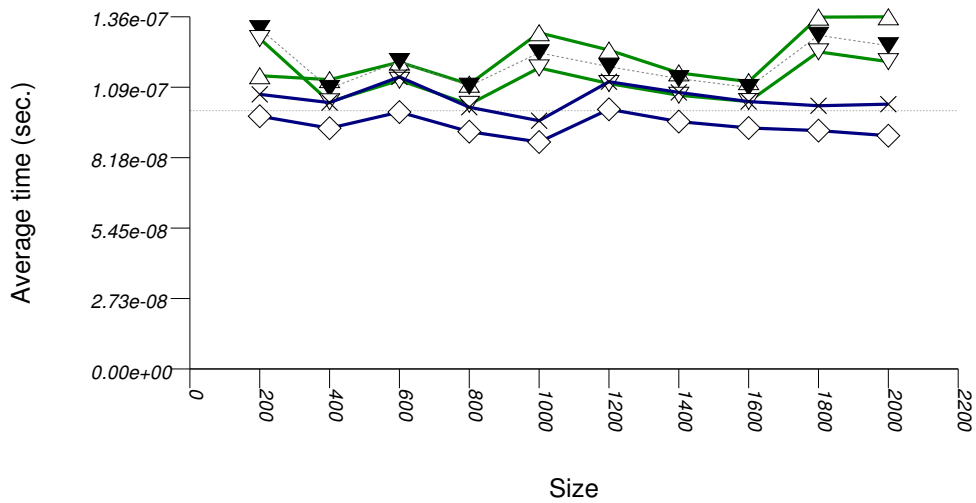

- △ cc_hash_mod_prime_nea_lc_1div8_1div2_nsth_map
- ▼ n_hash_map_ncah
- ▽ cc_hash_mod_prime_nea_lc_1div8_1div1_nsth_map
- × cc_hash_mask_exp_nea_lc_1div8_1div2_nsth_map
- ◇ cc_hash_mask_exp_nea_lc_1div8_1div1_nsth_map

The abbreviated names in the legend of the graphic above are instantiated with the types in the following table.

Name/Instantiating Type	Parameter	Details	Parameter	Details
n_hash_map_ncah				
std::tr1::unordered_map	cache_hash_code	false		
cc_hash_mod_prime_1div1_nsth_map				
cc_hash_table	Comb_Hash_Fn	direct_mod_range_hashing		
	Resize_Policy	hash_standard_resize_policy	Size_Policy	hash_prime_size_policy
			Trigger_Policy	hash_load_check_resize_trigger with $\alpha_{\min} = 1/8$ and $\alpha_{\max} = 1/1$
cc_hash_mod_prime_1div2_nsth_map				
cc_hash_table	Comb_Hash_Fn	direct_mod_range_hashing		
	Resize_Policy	hash_standard_resize_policy	Size_Policy	hash_prime_size_policy
			Trigger_Policy	hash_load_check_resize_trigger with $\alpha_{\min} = 1/8$ and $\alpha_{\max} = 1/2$
cc_hash_mask_exp_1div1_nsth_map				
cc_hash_table	Comb_Hash_Fn	direct_mask_range_hashing		
	Resize_Policy	hash_standard_resize_policy	Size_Policy	hash_exponential_size_policy

<i>Name/Instantiating Type</i>	<i>Parameter</i>	<i>Details</i>	<i>Parameter</i>	<i>Details</i>
			Trigger_Policy	hash_load_checker with $\alpha_{\min} = 1/8$ and $\alpha_{\max} = 1/1$
cc_hash_mask_exp_1div2_nsth_map				
cc_hash_table	Comb_Hash_Fn	direct_mask_range_hashing		
	Resize_Policy	hash_standard_resize_policy	Size_Policy	hash_exponential_size_policy
			Trigger_Policy	hash_load_checker with $\alpha_{\min} = 1/8$ and $\alpha_{\max} = 1/2$

And the second graphic shows the results for the native and general-probe hash types. The function applied being a random integer timing test using find.

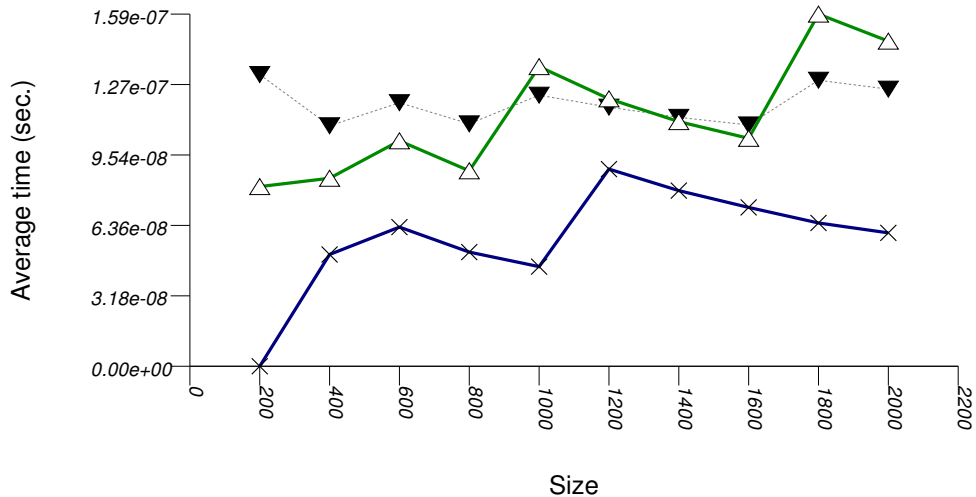

- ▼ n_hash_map_ncah
- ▲ gp_hash_mod_quadp_prime_nea_lc_1div8_1div2_nsth_map
- × gp_hash_mask_linp_exp_nea_lc_1div8_1div2_nsth_map

The abbreviated names in the legend of the graphic above are instantiated with the types in the following table.

<i>Name/Instantiating Type</i>	<i>Parameter</i>	<i>Details</i>	<i>Parameter</i>	<i>Details</i>
n_hash_map_ncah				
std::tr1::unordered_map	cache_hash_code	false		
gp_hash_mod_quadp_prime_1div2_nsth_map				
gp_hash_table	Comb_Hash_Fn	direct_mod_range_hashing		
	Probe_Fn	quadratic_probe_fn		

<i>Name/Instantiating Type</i>	<i>Parameter</i>	<i>Details</i>	<i>Parameter</i>	<i>Details</i>
	Resize_Policy	hash_standard_resize_policy	Size_Policy	hash_prime_size_policy
			Trigger_Policy	hash_load_checker with $\alpha_{\min} = 1/8$ and $\alpha_{\max} = 1/2$
gp_hash_mask_linp_exp_1div2_nsth_map				
gp_hash_table	Comb_Hash_Fn	direct_mask_range_hashing		
	Probe_Fn	linear_probe_fn		
	Resize_Policy	hash_standard_resize_policy	Size_Policy	hash_exponential_size_policy
			Trigger_Policy	hash_load_checker with $\alpha_{\min} = 1/8$ and $\alpha_{\max} = 1/2$

22.4.2.1.4.3 Observations

In this setting, as in Hash-Based Text `find` Find Timing test and Hash-Based Integer `find` Find Timing test, the choice of underlying hash-table affects performance most, then the range-hashing scheme, and finally any other policies.

There are some differences, however:

1. In this setting, probing tables function sometimes more efficiently than collision-chaining tables. This is explained shortly.
2. The performance graphs have a "saw-tooth" shape. The average insert time rises and falls. As values are inserted into the container, the load factor grows larger. Eventually, a resize occurs. The reallocations and rehashing are relatively expensive. After this, the load factor is smaller than before.

Collision-chaining containers use indirection for greater flexibility; probing containers store values contiguously, in an array (see Figure Motivation::Different underlying data structures A and B, respectively). It follows that for simple data types, probing containers access their allocator less frequently than collision-chaining containers, (although they still have less efficient probing sequences). This explains why some probing containers fare better than collision-chaining containers in this case.

Within each type of hash-table, the range-hashing scheme affects performance more than other policies. This is similar to the situation in Hash-Based Text `find` Find Timing Test and Hash-Based Integer `find` Find Timing Test. Unsurprisingly, however, containers with lower α_{\max} perform worse in this case, since more re-hashes are performed.

22.4.2.1.5 Integer `find` with Skewed-Distribution

22.4.2.1.5.1 Description

This test inserts a number of values with a markedly non-uniform integer keys into a container, then performs a series of finds using `find`. It measures the average time for `find` as a function of the number of values in the containers. The keys are generated as follows. First, a uniform integer is created. Then it is then shifted left 8 bits.

It uses the test file: `performance/ext/pb_ds/hash_zlob_random_int_find_timing.cc`

The test checks the effect of different range-hashing functions and trigger policies.

22.4.2.1.5.2 Results

The graphic below show the results for the native, collision-chaining, and general-probing hash types.

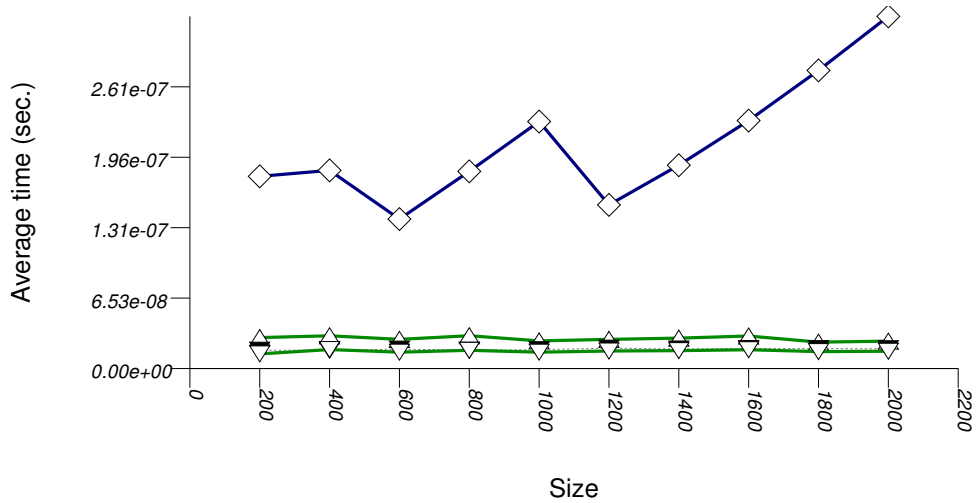

- ◇ cc_hash_mask_exp_nea_lc_1div8_1div1_nsth_map
- △ gp_hash_mod_quadp_prime_nea_lc_1div8_1div2_nsth_map
- ▼ n_hash_map_ncah
- ◻ cc_hash_mod_prime_nea_lc_1div8_1div1_nsth_map

The abbreviated names in the legend of the graphic above are instantiated with the types in the following table.

<i>Name/Instantiating Type</i>	<i>Parameter</i>	<i>Details</i>	<i>Parameter</i>	<i>Details</i>
n_hash_map_ncah				
std::tr1::unordered_map	cache_hash_code	false		
cc_hash_mod_prime_1div1_nsth_map				
cc_hash_table	Comb_Hash_Fn	direct_mod_range_hashing		
	Resize_Policy	hash_standard_resize_policy	Size_Policy	hash_prime_size_policy
			Trigger_Policy	hash_load_check_resize_trigger with $\alpha_{\min} = 1/8$ and $\alpha_{\max} = 1/1$
cc_hash_mask_exp_1div1_nsth_map				
cc_hash_table	Comb_Hash_Fn	direct_mask_range_hashing		
	Resize_Policy	hash_standard_resize_policy	Size_Policy	hash_exponential_size_policy
			Trigger_Policy	hash_load_check_resize_trigger with $\alpha_{\min} = 1/8$ and $\alpha_{\max} = 1/1$
gp_hash_mod_quadp_prime_1div2_nsth_map				
gp_hash_table	Comb_Hash_Fn	direct_mod_range_hashing		

<i>Name/Instantiating Type</i>	<i>Parameter</i>	<i>Details</i>	<i>Parameter</i>	<i>Details</i>
	Probe_Fn	quadratic_prob e_fn		
	Resize_Policy	hash_standard_ resize_policy	Size_Policy	hash_prime_siz e_policy
			Trigger_Policy	hash_load_chec k_resize_trig ger with $\alpha_{\min} = 1/8$ and $\alpha_{\max} = 1/2$

22.4.2.1.5.3 Observations

In this setting, the distribution of keys is so skewed that the underlying hash-table type affects performance marginally. (This is in contrast with Hash-Based Text `find` Find Timing Test, Hash-Based Integer `find` Find Timing Test, Hash-Based Integer Subscript Find Timing Test and Hash-Based Integer Subscript Insert Timing Test.)

The range-hashing scheme affects performance dramatically. A mask-based range-hashing scheme effectively maps all values into the same bucket. Access degenerates into a search within an unordered linked-list. In the graphic above, it should be noted that `std::tr1::unordered_map` is hard-wired currently to mod-based and mask-based schemes, respectively.

When observing the settings of this test, it is apparent that the keys' distribution is far from natural. One might ask if the test is not contrived to show that, in some cases, mod-based range hashing does better than mask-based range hashing. This is, in fact just the case. A more natural case in which mod-based range hashing is better was not encountered. Thus the inescapable conclusion: real-life key distributions are handled better with an appropriate hash function and a mask-based range-hashing function. (`pb_ds/example/hash_shift_mask.cc` shows an example of handling this a-priori known skewed distribution with a mask-based range-hashing function). If hash performance is bad, a χ^2 test can be used to check how to transform it into a more uniform distribution.

For this reason, this library's default range-hashing function is mask-based.

22.4.2.1.6 Erase Memory Use

22.4.2.1.6.1 Description

This test inserts a number of uniform integer keys into a container, then erases all keys except one. It measures the final size of the container.

It uses the test file: `performance/ext/pb_ds/hash_random_int_erase_mem_usage.cc`

The test checks how containers adjust internally as their logical size decreases.

22.4.2.1.6.2 Results

The graphic below show the results for the native, collision-chaining, and general-probing hash types.

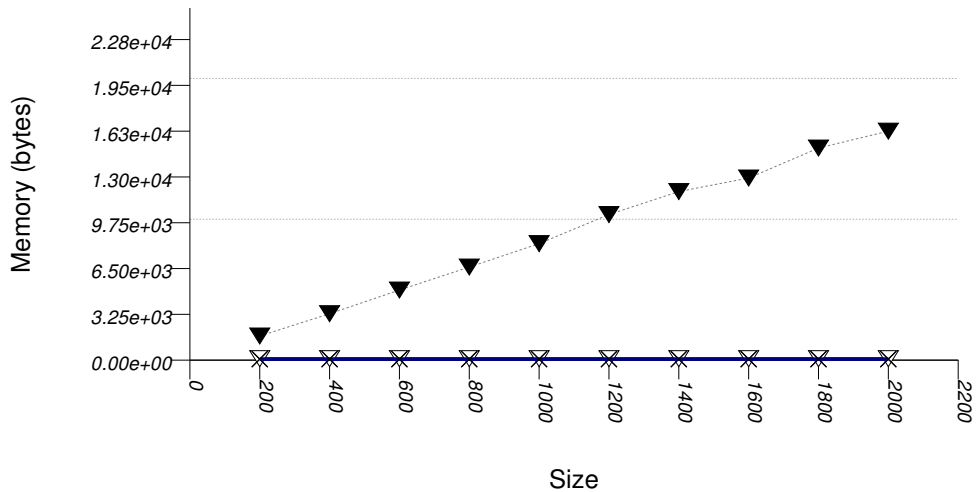

- ▼ n_hash_set_ncah
- ▽ cc_hash_mod_prime_nea_lc_1div8_1div1_nsth_set
- × cc_hash_mask_exp_nea_lc_1div8_1div2_nsth_set
- × gp_hash_mask_linp_exp_nea_lc_1div8_1div2_nsth_set

The abbreviated names in the legend of the graphic above are instantiated with the types in the following table.

<i>Name/Instantiating Type</i>	<i>Parameter</i>	<i>Details</i>	<i>Parameter</i>	<i>Details</i>
n_hash_map_ncah				
std::tr1::unordered_map	cache_hash_code	false		
cc_hash_mod_prime_1div1_nsth_map				
cc_hash_table	Comb_Hash_Fn	direct_mod_range_hashing		
	Resize_Policy	hash_standard_resize_policy	Size_Policy	hash_prime_size_policy
Trigger_Policy			hash_load_checker with $\alpha_{\min} = 1/8$ and $\alpha_{\max} = 1/1$	
cc_hash_mask_exp_1div2_nsth_map				
cc_hash_table	Comb_Hash_Fn	direct_mask_range_hashing		
	Resize_Policy	hash_standard_resize_policy	Size_Policy	hash_exponential_size_policy
Trigger_Policy			hash_load_checker with $\alpha_{\min} = 1/8$ and $\alpha_{\max} = 1/2$	
gp_hash_mask_linp_exp_1div2_nsth_set				
gp_hash_table	Comb_Hash_Fn	direct_mask_range_hashing		
	Probe_Fn	linear_probe_fn		
	Resize_Policy	hash_standard_resize_policy	Size_Policy	hash_exponential_size_policy

<i>Name/Instantiating Type</i>	<i>Parameter</i>	<i>Details</i>	<i>Parameter</i>	<i>Details</i>
			Trigger_Policy	hash_load_checker with $\alpha_{\min} = 1/8$ and $\alpha_{\max} = 1/2$

22.4.2.1.6.3 Observations

The standard’s hash-based containers act very differently than trees in this respect. When erasing numerous keys from an standard associative-container, the resulting memory user varies greatly depending on whether the container is tree-based or hash-based. This is a fundamental consequence of the standard’s interface for associative containers, and it is not due to a specific implementation.

22.4.2.2 Branch-Based

22.4.2.2.1 Text insert

22.4.2.2.1.1 Description

This test inserts a number of values with keys from an arbitrary text ([wickland96thirty]) into a container using `insert`. It measures the average time for `insert` as a function of the number of values inserted.

The test checks the effect of different underlying data structures.

It uses the test file: `performance/ext/pb_ds/tree_text_insert_timing.cc`

22.4.2.2.1.2 Results

The three graphics below show the results for the native tree and this library’s node-based trees, the native tree and this library’s vector-based trees, and the native tree and this library’s PATRICIA-trie, respectively.

The graphic immediately below shows the results for the native tree and several node-based tree types.

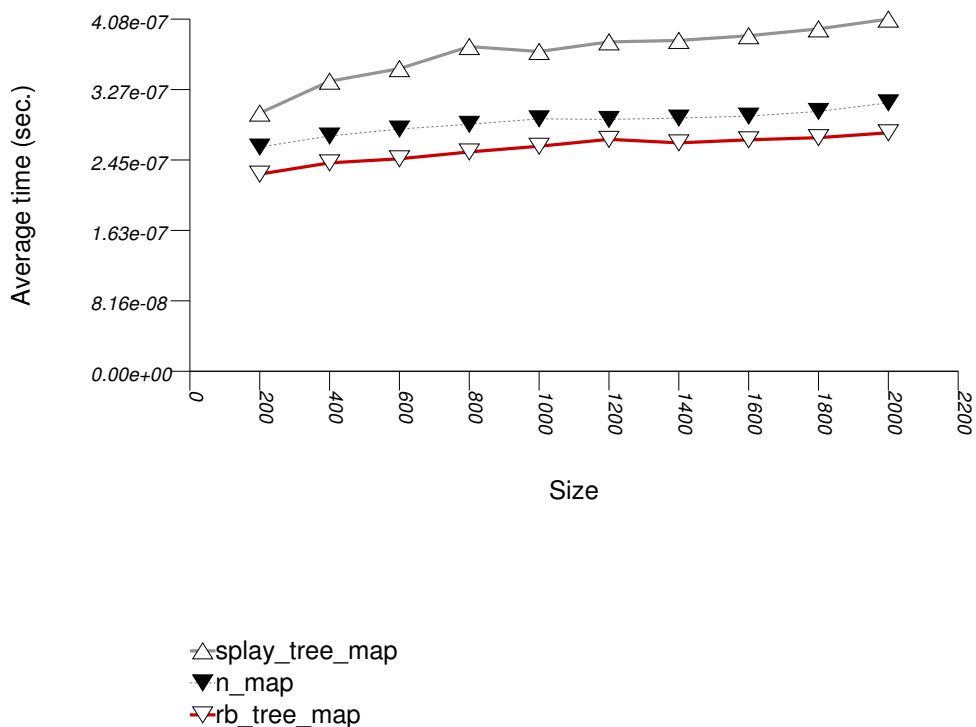

The abbreviated names in the legend of the graphic above are instantiated with the types in the following table.

<i>Name/Instantiating Type</i>	<i>Parameter</i>	<i>Details</i>
n_map		
std::map		
splay_tree_map		
tree	Tag	splay_tree_tag
	Node_update	null_node_update
rb_tree_map		
tree	Tag	rb_tree_tag
	Node_update	null_node_update

The graphic below shows the results for the native tree type and a vector-based tree type.

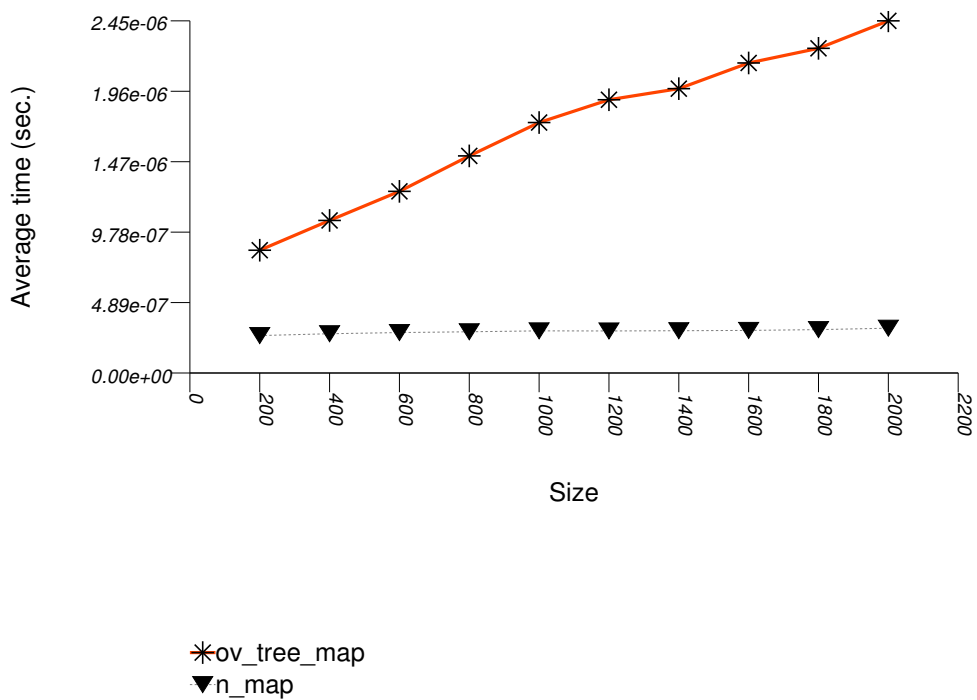

The abbreviated names in the legend of the graphic above are instantiated with the types in the following table.

<i>Name/Instantiating Type</i>	<i>Parameter</i>	<i>Details</i>
n_map		
std::map		
ov_tree_map		
tree	Tag	ov_tree_tag
	Node_update	null_node_update

The graphic below shows the results for the native tree type and a PATRICIA trie type.

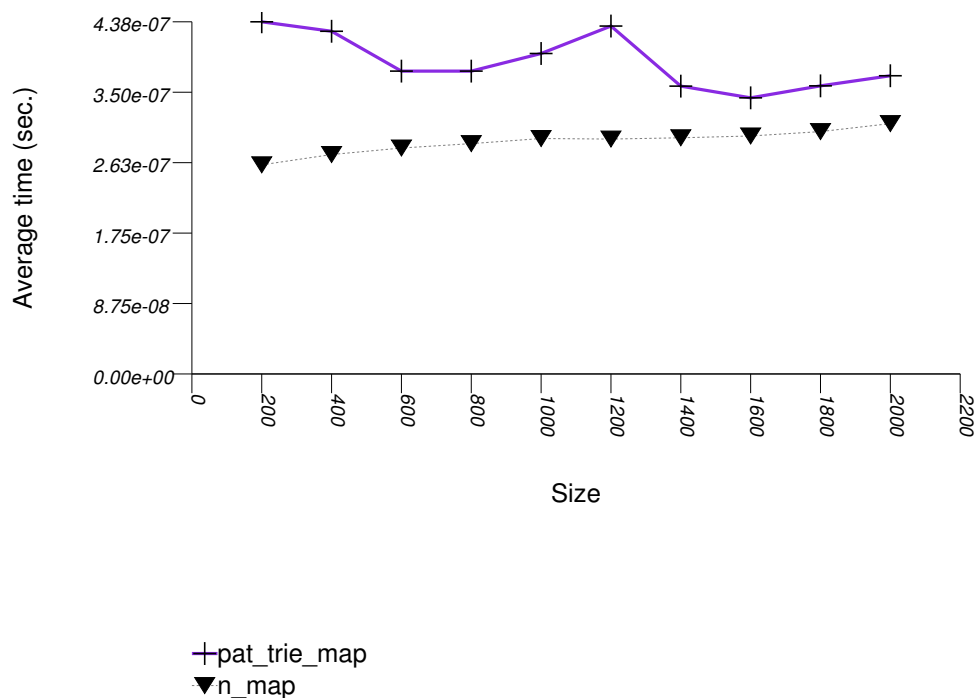

The abbreviated names in the legend of the graphic above are instantiated with the types in the following table.

Name/Instantiating Type	Parameter	Details
n_map		
std::map		
pat_trie_map		
tree	Tag	pat_trie_tag
	Node_update	null_node_update

22.4.2.2.1.3 Observations

Observing the first graphic implies that for this setting, a splay tree (tree with Tag = splay_tree_tag) does not do well. See also the Branch-Based Text find Find Timing Test. The two red-black trees perform better.

Observing the second graphic, an ordered-vector tree (tree with Tag = ov_tree_tag) performs abysmally. Inserting into this type of tree has linear complexity [austern00noset].

Observing the third and last graphic, A PATRICIA trie (trie with Tag = pat_trie_tag) has abysmal performance, as well. This is not that surprising, since a large-fan-out PATRICIA trie works like a hash table with collisions resolved by a sub-trie. Each time a collision is encountered, a new "hash-table" is built. A large fan-out PATRICIA trie, however, does well in look-ups (see Branch-Based Text find Find Timing Test). It may be beneficial in semi-static settings.

22.4.2.2.2 Text find

22.4.2.2.2.1 Description

This test inserts a number of values with keys from an arbitrary text ([wickland96thirty]) into a container, then performs a series of finds using find. It measures the average time for find as a function of the number of values inserted.

It uses the test file: performance/ext/pb_ds/text_find_timing.cc

The test checks the effect of different underlying data structures.

22.4.2.2.2 Results

The graphic immediately below shows the results for the native tree type and several other tree types.

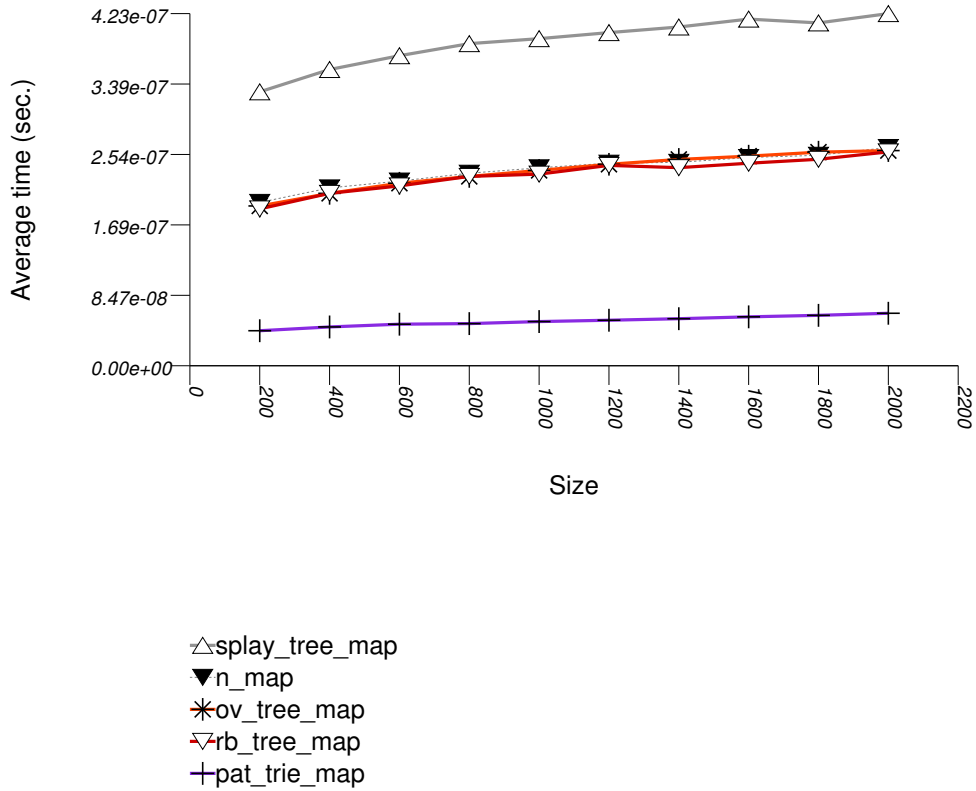

The abbreviated names in the legend of the graphic above are instantiated with the types in the following table.

<i>Name/Instantiating Type</i>	<i>Parameter</i>	<i>Details</i>
n_map		
std::map		
splay_tree_map		
tree	Tag	splay_tree_tag
	Node_Update	null_node_update
rb_tree_map		
tree	Tag	rb_tree_tag
	Node_Update	null_node_update
ov_tree_map		
tree	Tag	ov_tree_tag
	Node_Update	null_node_update
pat_trie_map		
tree	Tag	pat_trie_tag
	Node_Update	null_node_update

22.4.2.2.3 Observations

For this setting, a splay tree (tree with Tag = splay_tree_tag) does not do well. This is possibly due to two reasons:

1. A splay tree is not guaranteed to be balanced [motwani95random]. If a splay tree contains n nodes, its average root-leaf path can be $m \gg \log(n)$.

- Assume a specific root-leaf search path has length m , and the search-target node has distance m' from the root. A red-black tree will require $m + 1$ comparisons to find the required node; a splay tree will require $2 m'$ comparisons. A splay tree, consequently, can perform many more comparisons than a red-black tree.

An ordered-vector tree (`tree` with `Tag = ov_tree_tag`), a red-black tree (`tree` with `Tag = rb_tree_tag`), and the native red-black tree all share approximately the same performance.

An ordered-vector tree is slightly slower than red-black trees, since it requires, in order to find a key, more math operations than they do. Conversely, an ordered-vector tree requires far lower space than the others. ([austern00noset], however, seems to have an implementation that is also faster than a red-black tree).

A PATRICIA trie (`trie` with `Tag = pat_trie_tag`) has good look-up performance, due to its large fan-out in this case. In this setting, a PATRICIA trie has look-up performance comparable to a hash table (see Hash-Based Text `find` Timing Test), but it is order preserving. This is not that surprising, since a large-fan-out PATRICIA trie works like a hash table with collisions resolved by a sub-trie. A large-fan-out PATRICIA trie does not do well on modifications (see Tree-Based and Trie-Based Text Insert Timing Test). Therefore, it is possibly beneficial in semi-static settings.

22.4.2.2.3 Text `find` with Locality-of-Reference

22.4.2.2.3.1 Description

This test inserts a number of values with keys from an arbitrary text ([wickland96thirty]) into a container, then performs a series of finds using `find`. It is different than Tree-Based and Trie-Based Text `find` Find Timing Test in the sequence of finds it performs: this test performs multiple `finds` on the same key before moving on to the next key. It measures the average time for `find` as a function of the number of values inserted.

It uses the test file: `performance/ext/pb_ds/tree_text_lor_find_timing.cc`

The test checks the effect of different underlying data structures in a locality-of-reference setting.

22.4.2.2.3.2 Results

The graphic immediately below shows the results for the native tree type and several other tree types.

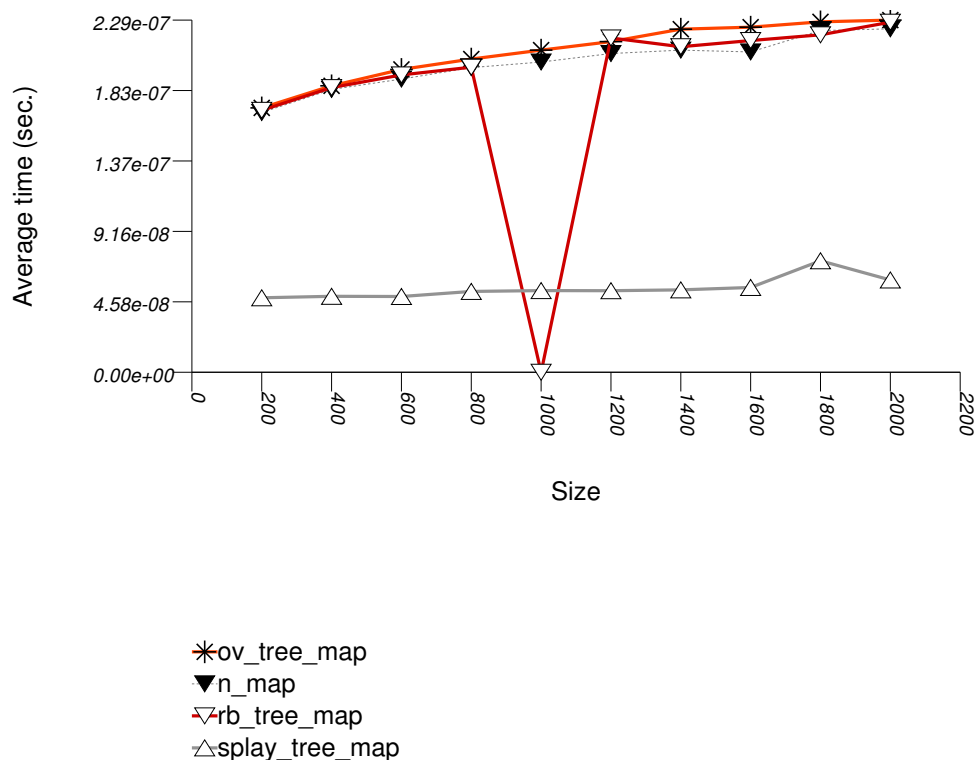

The abbreviated names in the legend of the graphic above are instantiated with the types in the following table.

<i>Name/Instantiating Type</i>	<i>Parameter</i>	<i>Details</i>
<code>n_map</code>		
<code>std::map</code>		
<code>splay_tree_map</code>		
<code>tree</code>	<code>Tag</code>	<code>splay_tree_tag</code>
	<code>Node_Update</code>	<code>null_node_update</code>
<code>rb_tree_map</code>		
<code>tree</code>	<code>Tag</code>	<code>rb_tree_tag</code>
	<code>Node_Update</code>	<code>null_node_update</code>
<code>ov_tree_map</code>		
<code>tree</code>	<code>Tag</code>	<code>ov_tree_tag</code>
	<code>Node_Update</code>	<code>null_node_update</code>
<code>pat_trie_map</code>		
<code>tree</code>	<code>Tag</code>	<code>pat_trie_tag</code>
	<code>Node_Update</code>	<code>null_node_update</code>

22.4.2.2.3.3 Observations

For this setting, an ordered-vector tree (`tree` with `Tag = ov_tree_tag`), a red-black tree (`tree` with `Tag = rb_tree_tag`), and the native red-black tree all share approximately the same performance.

A splay tree (`tree` with `Tag = splay_tree_tag`) does much better, since each (successful) find "bubbles" the corresponding node to the root of the tree.

22.4.2.2.4 split and join

22.4.2.2.4.1 Description

This test a container, inserts into a number of values, splits the container at the median, and joins the two containers. (If the containers are one of this library's trees, it splits and joins with the `split` and `join` method; otherwise, it uses the `erase` and `insert` methods.) It measures the time for splitting and joining the containers as a function of the number of values inserted.

It uses the test file: `performance/ext/pb_ds/tree_split_join_timing.cc`

The test checks the performance difference of `join` as opposed to a sequence of `insert` operations; by implication, this test checks the most efficient way to erase a sub-sequence from a tree-like-based container, since this can always be performed by a small sequence of splits and joins.

22.4.2.2.4.2 Results

The graphic immediately below shows the results for the native tree type and several other tree types.

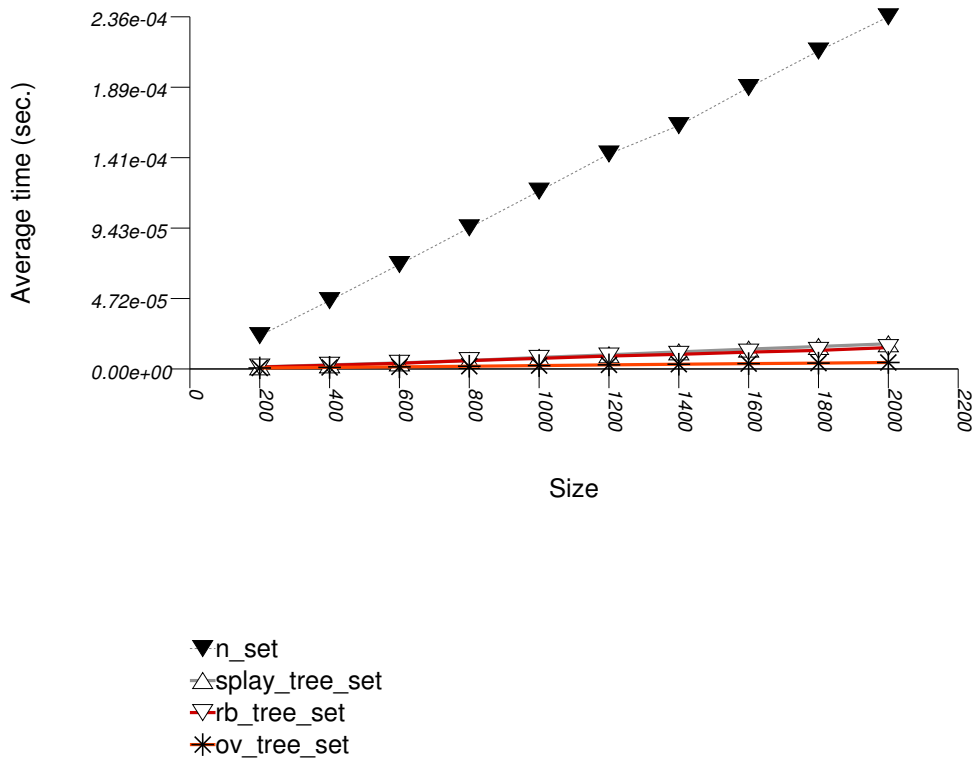

The abbreviated names in the legend of the graphic above are instantiated with the types in the following table.

Name/Instantiating Type	Parameter	Details
n_set		
std::set		
splay_tree_set		
tree	Tag	splay_tree_tag
	Node_Update	null_node_update
rb_tree_set		
tree	Tag	rb_tree_tag
	Node_Update	null_node_update
ov_tree_set		
tree	Tag	ov_tree_tag
	Node_Update	null_node_update
pat_trie_map		
tree	Tag	pat_trie_tag
	Node_Update	null_node_update

22.4.2.2.4.3 Observations

In this test, the native red-black trees must be split and joined externally, through a sequence of `erase` and `insert` operations. This is clearly super-linear, and it is not that surprising that the cost is high.

This library's tree-based containers use in this test the `split` and `join` methods, which have lower complexity: the `join` method of a splay tree (`tree` with `Tag = splay_tree_tag`) is quadratic in the length of the longest root-leaf path, and linear in the total number of elements; the `join` method of a red-black tree (`tree` with `Tag = rb_tree_tag`) or an ordered-vector tree (`tree` with `Tag = ov_tree_tag`) is linear in the number of elements.

Asides from orders of growth, this library's trees access their allocator very little in these operations, and some of them do not access it at all. This leads to lower constants in their complexity, and, for some containers, to exception-free splits and joins (which can be determined via `container_traits`).

It is important to note that `split` and `join` are not esoteric methods - they are the most efficient means of erasing a contiguous range of values from a tree based container.

22.4.2.2.5 Order-Statistics

22.4.2.2.5.1 Description

This test creates a container, inserts random integers into the the container, and then checks the order-statistics of the container's values. (If the container is one of this library's trees, it does this with the `order_of_key` method of `tree_order_statistics_node_update`; otherwise, it uses the `find` method and `std::distance`.) It measures the average time for such queries as a function of the number of values inserted.

It uses the test file: `performance/ext/pb_ds/tree_order_statistics_timing.cc`

The test checks the performance difference of policies based on node-invariant as opposed to a external functions.

22.4.2.2.5.2 Results

The graphic immediately below shows the results for the native tree type and several other tree types.

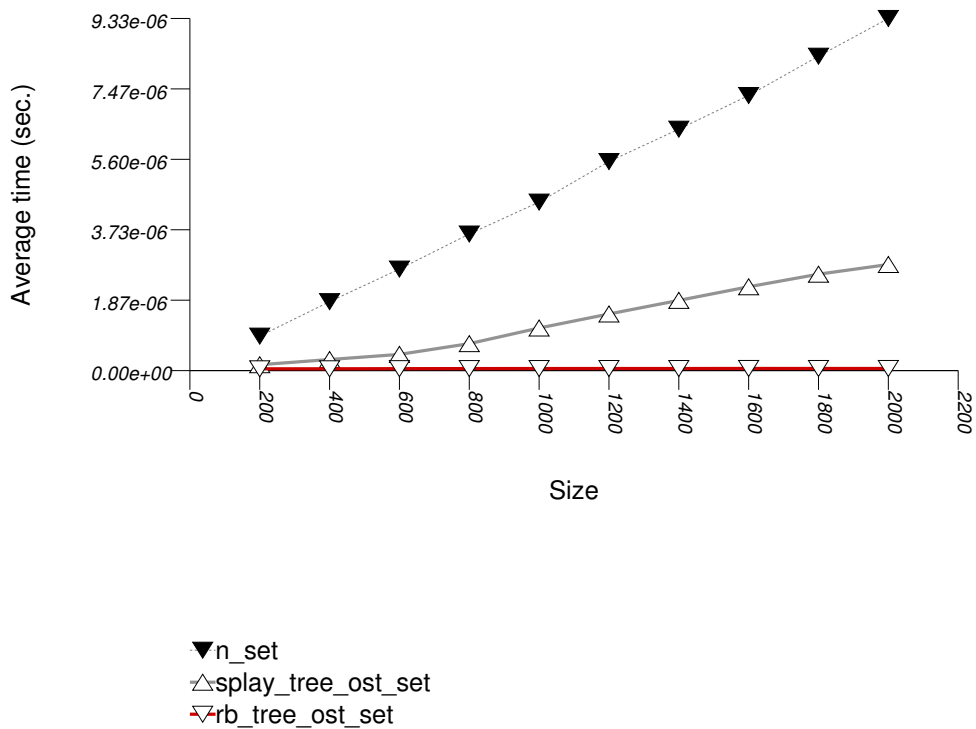

The abbreviated names in the legend of the graphic above are instantiated with the types in the following table.

<i>Name/Instantiating Type</i>	<i>Parameter</i>	<i>Details</i>
n_set		
std::set		
splay_tree_ost_set		
tree	Tag	splay_tree_tag
	Node_Update	tree_order_statistics_node_update
rb_tree_ost_set		
tree	Tag	rb_tree_tag
	Node_Update	tree_order_statistics_node_update

22.4.2.2.5.3 Observations

In this test, the native red-black tree can support order-statistics queries only externally, by performing a `find` (alternatively, `lower_bound` or `upper_bound`) and then using `std::distance`. This is clearly linear, and it is not that surprising that the cost is high.

This library's tree-based containers use in this test the `order_of_key` method of `tree_order_statistics_node_update`. This method has only linear complexity in the length of the root-node path. Unfortunately, the average path of a splay tree (tree with `Tag = splay_tree_tag`) can be higher than logarithmic; the longest path of a red-black tree (tree with `Tag = rb_tree_tag`) is logarithmic in the number of elements. Consequently, the splay tree has worse performance than the red-black tree.

22.4.2.3 Multimap

22.4.2.3.1 Text `find` with Small Secondary-to-Primary Key Ratios

22.4.2.3.1.1 Description

This test inserts a number of pairs into a container. The first item of each pair is a string from an arbitrary text [wickland96thirty], and the second is a uniform i.i.d. integer. The container is a "multimap" - it considers the first member of each pair as a primary key, and the second member of each pair as a secondary key (see `Motivation::Associative Containers::Alternative to Multiple Equivalent Keys`). There are 400 distinct primary keys, and the ratio of secondary keys to primary keys ranges from 1 to 5.

The test measures the average find-time as a function of the number of values inserted. For this library's containers, it finds the secondary key from a container obtained from finding a primary key. For the native multimaps, it searches a range obtained using `std::equal_range` on a primary key.

It uses the test file: `performance/ext/pb_ds/multimap_text_find_timing_small.cc`

The test checks the find-time scalability of different "multimap" designs.

22.4.2.3.1.2 Results

The graphic below show the results for "multimaps" which use a tree-based container for primary keys.

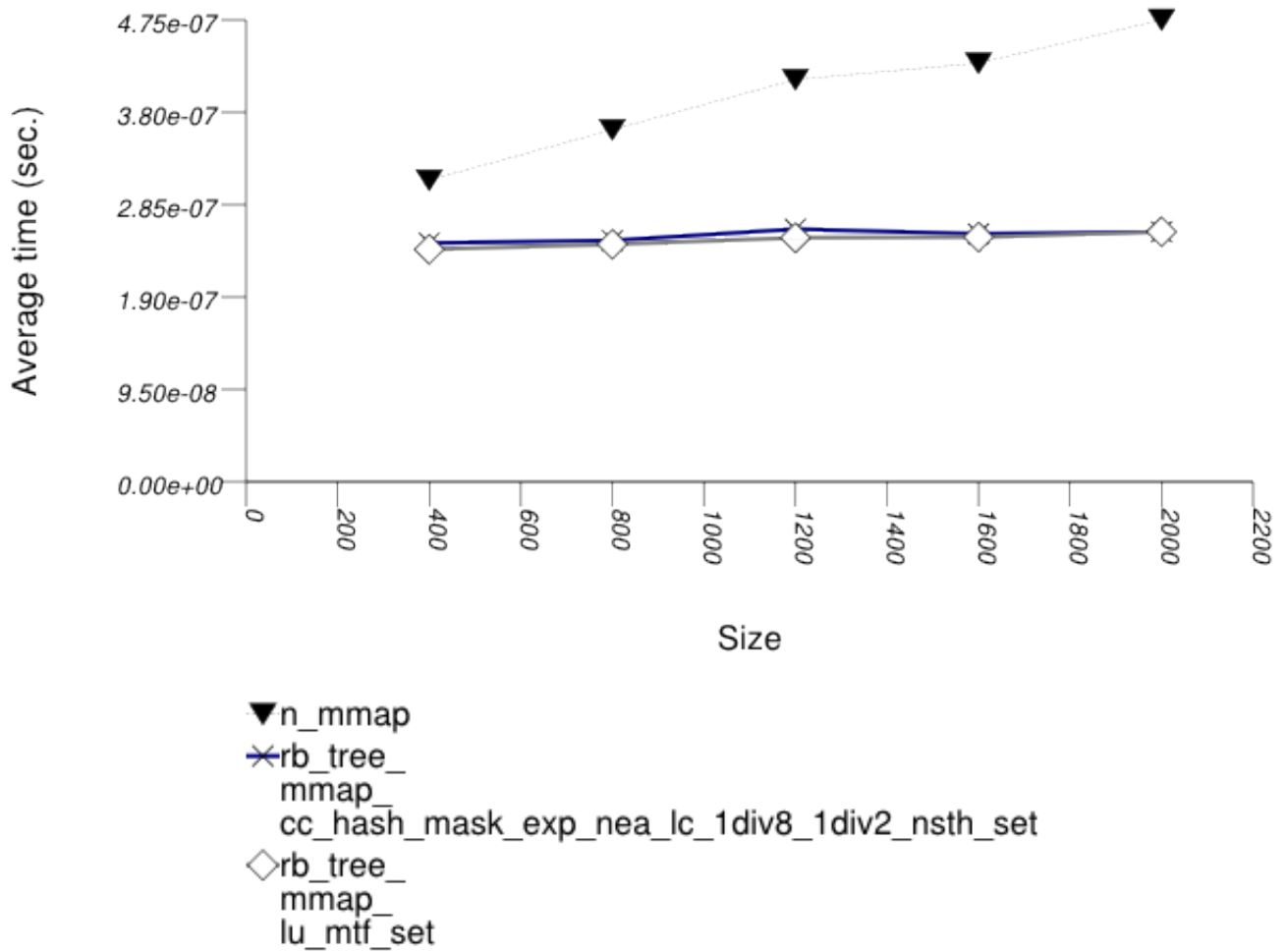

The abbreviated names in the legend of the graphic above are instantiated with the types in the following table.

<i>Name/Instantiating Type</i>	<i>Parameter</i>	<i>Details</i>	<i>Parameter</i>	<i>Details</i>	<i>Parameter</i>	<i>Details</i>
n_mmap						
std::multimap						
rb_tree_mmap_lu_mtf_set						
tree	Tag	rb_tree_tag				
	Node_Update	null_node_update				
	Mapped	list_update	Update_Policy	lu_move_to_front_policy		
rb_tree_mmap_cc_hash_mask_exp_1div2_nsth_set						
tree	Tag	rb_tree_tag				
	Node_Update	null_node_update				
	Mapped	cc_hash_table	Comb_Hash_Fn	direct_mask_range_hashing		

<i>Name/Instantiating Type</i>	<i>Parameter</i>	<i>Details</i>	<i>Parameter</i>	<i>Details</i>	<i>Parameter</i>	<i>Details</i>
			Resize_Policy	hash_standard_resize_policy	Size_Policy	hash_exponential_size_policy
					Trigger_Policy	hash_load_check_resize_trigger with $\alpha_{\min} = 1/8$ and $\alpha_{\max} = 1/2$

The graphic below show the results for "multimaps" which use a hash-based container for primary keys.

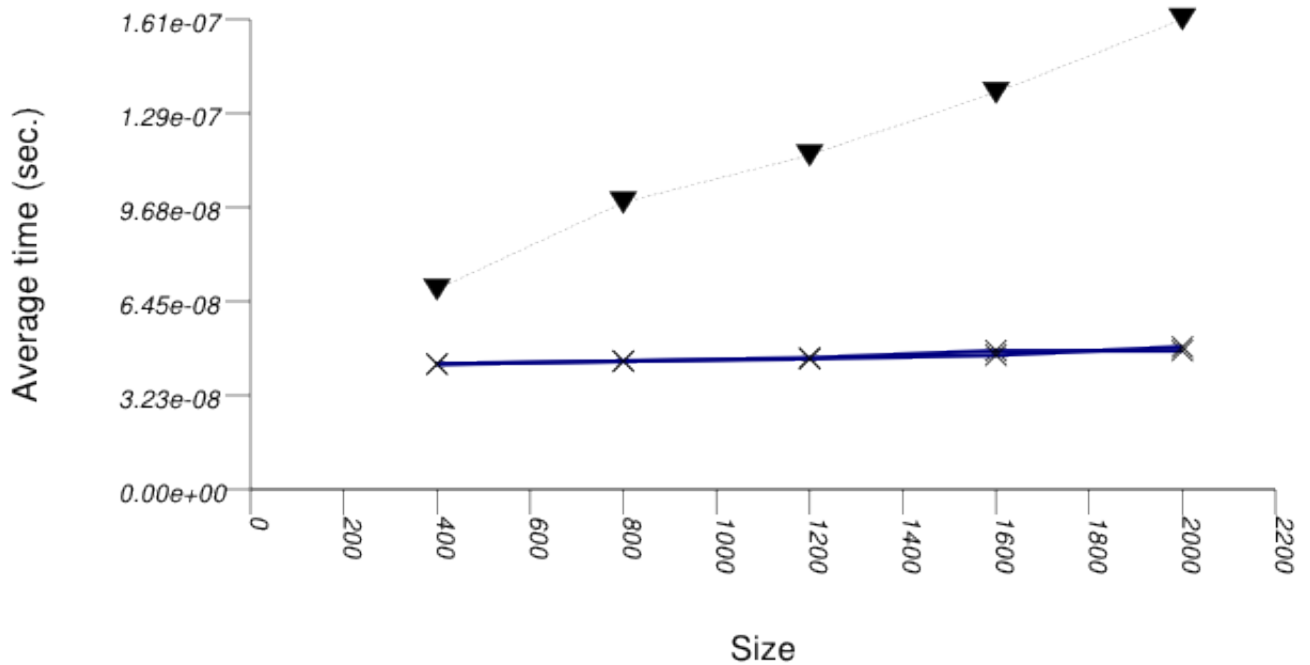

- ▼ n_hash_mmap
- × cc_hash_mask_exp_nea_lc_1div8_1div2_nsth_mmap
- × cc_hash_mask_exp_nea_lc_1div8_1div2_nsth_mmap_lu_mtf_set

The abbreviated names in the legend of the graphic above are instantiated with the types in the following table.

<i>Name/Instantiating Type</i>	<i>Parameter</i>	<i>Details</i>	<i>Parameter</i>	<i>Details</i>	<i>Parameter</i>	<i>Details</i>
n_hash_mmap						
std::tr1::unordered_multimap						

<i>Name/Instantiating Type</i>	<i>Parameter</i>	<i>Details</i>	<i>Parameter</i>	<i>Details</i>	<i>Parameter</i>	<i>Details</i>	
rb_tree_mmap_lu_mtf_set							
cc_hash_table	Comb_Hash_Fn	direct_mask_range_hashing					
	Resize_Policy	hash_standard_resize_policy	Size_Policy	hash_exponential_size_policy			
			Trigger_Policy	hash_load_check_resize_trigger with $\alpha_{min} = 1/8$ and $\alpha_{max} = 1/2$			
Mapped	list_update	Update_Policy	lu_move_to_front_policy				
rb_tree_mmap_cc_hash_mask_exp_ldiv2_nsth_set							
cc_hash_table	Comb_Hash_Fn	direct_mask_range_hashing					
	Resize_Policy	hash_standard_resize_policy	Size_Policy	hash_exponential_size_policy			
			Trigger_Policy	hash_load_check_resize_trigger with $\alpha_{min} = 1/8$ and $\alpha_{max} = 1/2$			
	Mapped	cc_hash_table	Comb_Hash_Fn	direct_mask_range_hashing			
			Resize_Policy	hash_standard_resize_policy	Size_Policy	hash_exponential_size_policy	
					Trigger_Policy	hash_load_check_resize_trigger with $\alpha_{min} = 1/8$ and $\alpha_{max} = 1/2$	

22.4.2.3.1.3 Observations

See Observations::Mapping-Semantics Considerations.

22.4.2.3.2 Text `find` with Large Secondary-to-Primary Key Ratios

22.4.2.3.2.1 Description

This test inserts a number of pairs into a container. The first item of each pair is a string from an arbitrary text [wickland96thirty], and the second is a uniform integer. The container is a "multimap" - it considers the first member of each pair as a primary key, and the second member of each pair as a secondary key. There are 400 distinct primary keys, and the ratio of secondary keys to primary keys ranges from 1 to 5.

The test measures the average find-time as a function of the number of values inserted. For this library's containers, it finds the secondary key from a container obtained from finding a primary key. For the native multimaps, it searches a range obtained using `std::equal_range` on a primary key.

It uses the test file: `performance/ext/pb_ds/multimap_text_find_timing_large.cc`

The test checks the find-time scalability of different "multimap" designs.

22.4.2.3.2.2 Results

The graphic below show the results for "multimaps" which use a tree-based container for primary keys.

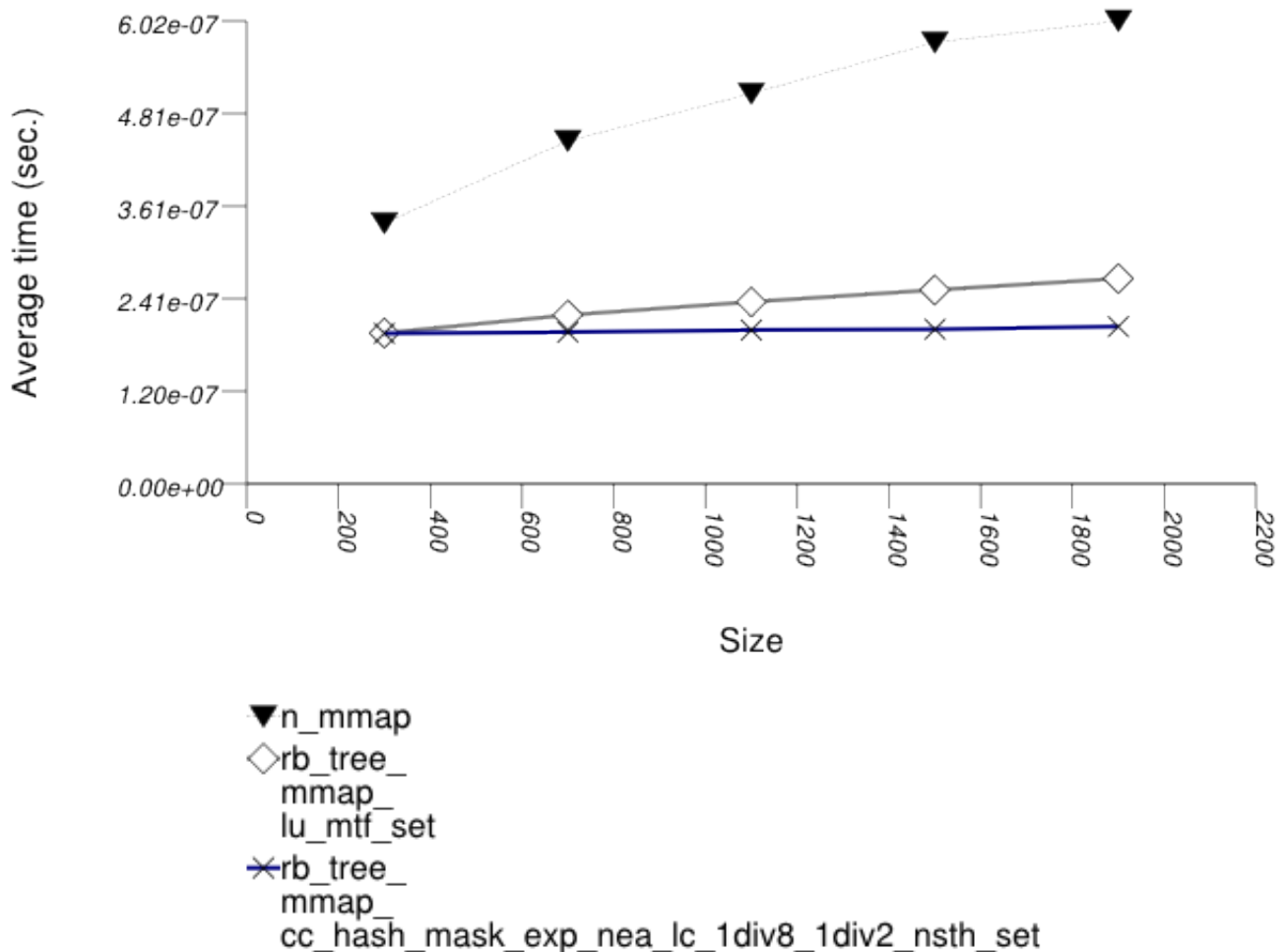

The abbreviated names in the legend of the graphic above are instantiated with the types in the following table.

<i>Name/Instantiating Type</i>	<i>Parameter</i>	<i>Details</i>	<i>Parameter</i>	<i>Details</i>	<i>Parameter</i>	<i>Details</i>
n_mmap						
std::multimap						
rb_tree_mmap_lu_mtf_set						
tree	Tag	rb_tree_tag				
	Node_Update	null_node_update				
	Mapped	list_update	Update_Policy	lu_move_to_front_policy		
rb_tree_mmap_cc_hash_mask_exp_ldiv2_nsth_set						
tree	Tag	rb_tree_tag				
	Node_Update	null_node_update				
	Mapped	cc_hash_table	Comb_Hash_Fn	direct_mask_range_hashing		
			Resize_Policy	hash_standard_resize_policy	Size_Policy	hash_exponential_size_policy
				Trigger_Policy	hash_load_check_resize_trigger with $\alpha_{\min} = 1/8$ and $\alpha_{\max} = 1/2$	

The graphic below show the results for "multimaps" which use a hash-based container for primary keys.

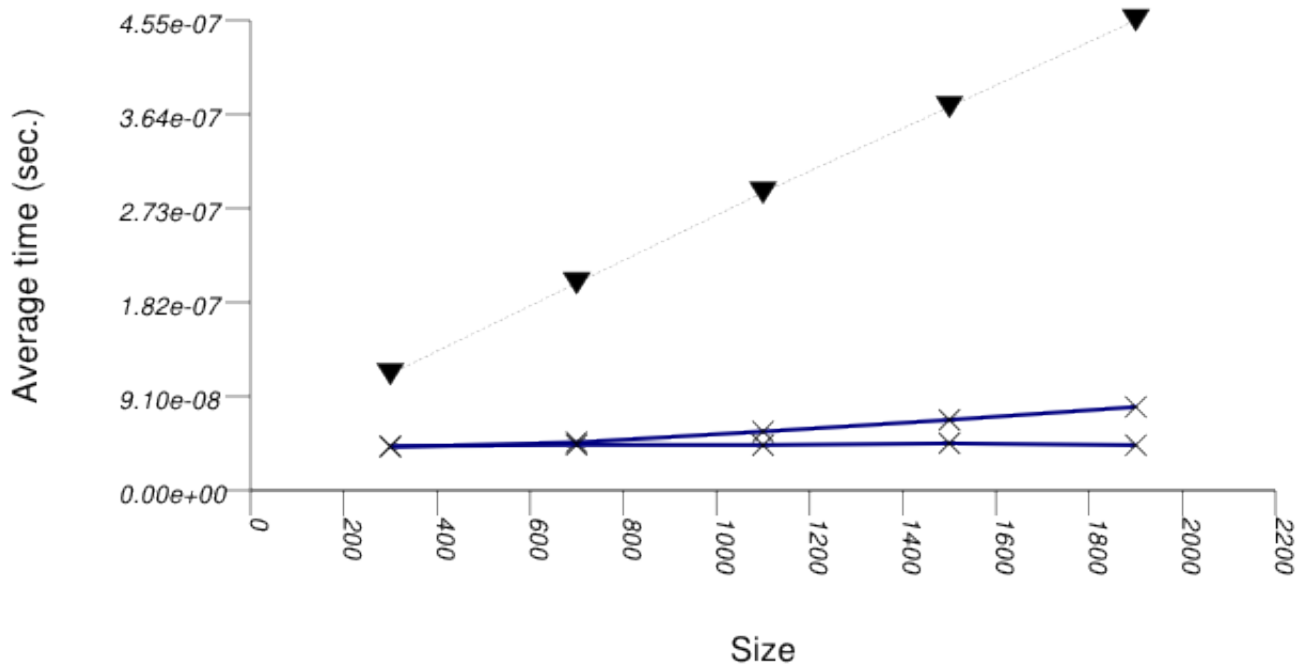

- ▼ n_hash_mmap
- ✕ cc_hash_mask_exp_nea_lc_1div8_1div2_nsth_mmap_lu_mtf_set
- ✕ cc_hash_mask_exp_nea_lc_1div8_1div2_nsth_mmap_cc_hash_mask_exp_nea_lc_1div8_1div2_nsth_set

The abbreviated names in the legend of the graphic above are instantiated with the types in the following table.

Name/Instantiating Type	Parameter	Details	Parameter	Details	Parameter	Details
n_hash_mmap						
std::tr1: unordered_multimap						
rb_tree_mmap_lu_mtf_set						
cc_hash_table	Comb_Hash_Fn	direct_mask_range_hashing				
	Resize_Policy	hash_standard_resize_policy	Size_Policy	hash_exponential_size_policy		
Trigger_Policy			hash_load_check_resize_trigger with $\alpha_{min} = 1/8$ and $\alpha_{max} = 1/2$			

<i>Name/Instantiating Type</i>	<i>Parameter</i>	<i>Details</i>	<i>Parameter</i>	<i>Details</i>	<i>Parameter</i>	<i>Details</i>	
	Mapped	list_update	Update_Policy	lu_move_to_front_policy			
rb_tree_mmap_cc_hash_mask_exp_ldiv2_nsth_set							
cc_hash_table	Comb_Hash_Fn	direct_mask_range_hashing					
	Resize_Policy	hash_standard_resize_policy	Size_Policy	hash_exponential_size_policy			
			Trigger_Policy	hash_load_check_resize_trigger with $\alpha_{\min} = 1/8$ and $\alpha_{\max} = 1/2$			
	Mapped	cc_hash_table	Comb_Hash_Fn	direct_mask_range_hashing			
			Resize_Policy	hash_standard_resize_policy	Size_Policy	hash_exponential_size_policy	
					Trigger_Policy	hash_load_check_resize_trigger with $\alpha_{\min} = 1/8$ and $\alpha_{\max} = 1/2$	

22.4.2.3.2.3 Observations

See Observations::Mapping-Semantics Considerations.

22.4.2.3.3 Text insert with Small Secondary-to-Primary Key Ratios

22.4.2.3.3.1 Description

This test inserts a number of pairs into a container. The first item of each pair is a string from an arbitrary text [wickland96thirty], and the second is a uniform integer. The container is a "multimap" - it considers the first member of each pair as a primary key, and the second member of each pair as a secondary key. There are 400 distinct primary keys, and the ratio of secondary keys to primary keys ranges from 1 to 5.

The test measures the average insert-time as a function of the number of values inserted. For this library's containers, it inserts a primary key into the primary associative container, then a secondary key into the secondary associative container. For the native multimaps, it obtains a range using `std::equal_range`, and inserts a value only if it was not contained already.

It uses the test file: `performance/ext/pb_ds/multimap_text_insert_timing_small.cc`

The test checks the insert-time scalability of different "multimap" designs.

22.4.2.3.3.2 Results

The graphic below show the results for "multimaps" which use a tree-based container for primary keys.

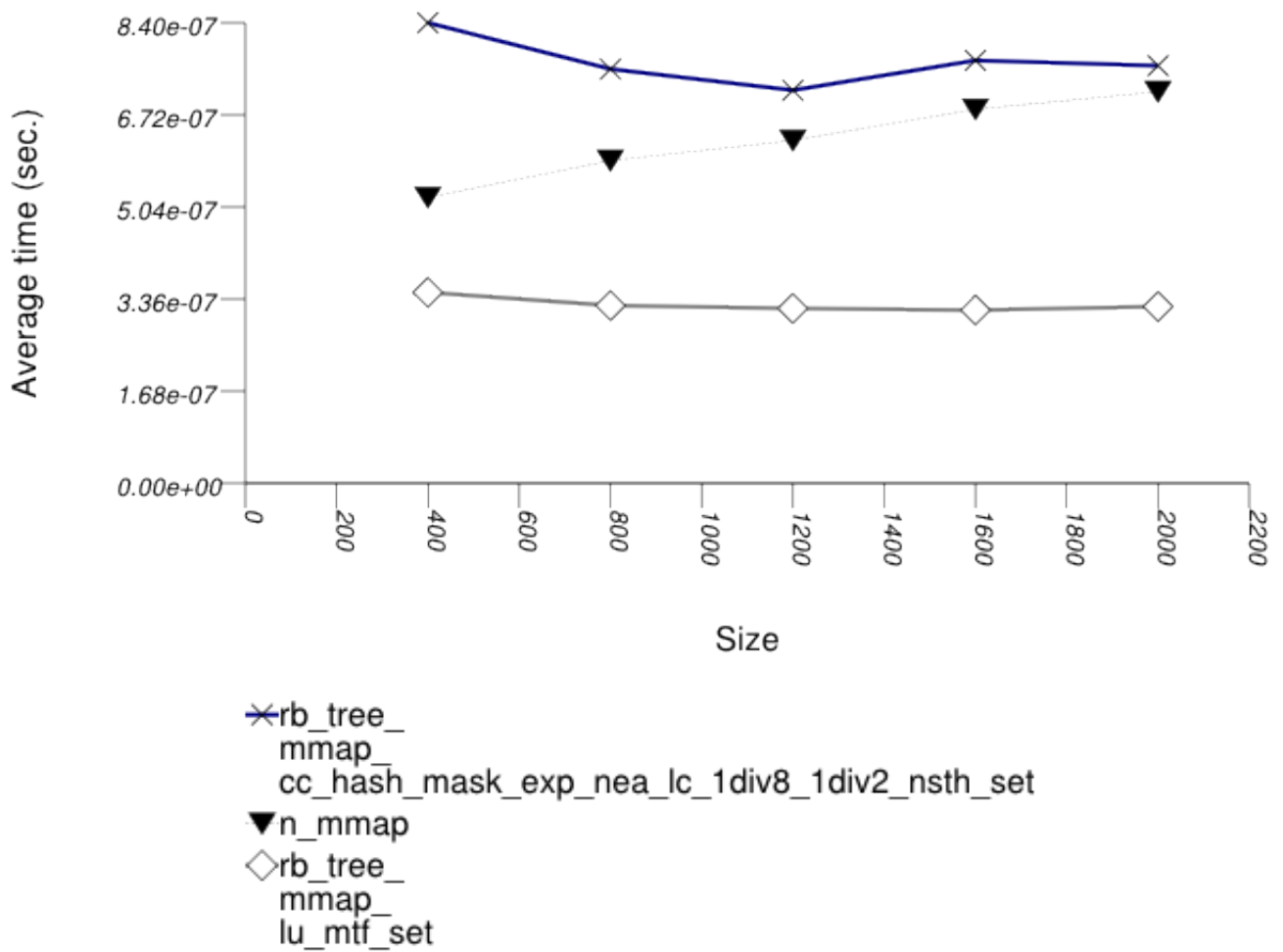

The abbreviated names in the legend of the graphic above are instantiated with the types in the following table.

<i>Name/Instantiating Type</i>	<i>Parameter</i>	<i>Details</i>	<i>Parameter</i>	<i>Details</i>	<i>Parameter</i>	<i>Details</i>
n_mmap						
std::multimap						
rb_tree_mmap_lu_mtf_set						
tree	Tag	rb_tree_tag				
	Node_Update	null_node_update				
	Mapped	list_update	Update_Policy	lu_move_to_front_policy		
rb_tree_mmap_cc_hash_mask_exp_1div2_nsth_set						
tree	Tag	rb_tree_tag				
	Node_Update	null_node_update				
	Mapped	cc_hash_table	Comb_Hash_Fn	direct_mask_range_hashing		

<i>Name/Instantiating Type</i>	<i>Parameter</i>	<i>Details</i>	<i>Parameter</i>	<i>Details</i>	<i>Parameter</i>	<i>Details</i>
			Resize_Policy	hash_standard_resize_policy	Size_Policy	hash_exponential_size_policy
					Trigger_Policy	hash_load_check_resize_trigger with $\alpha_{\min} = 1/8$ and $\alpha_{\max} = 1/2$

The graphic below show the results for "multimaps" which use a hash-based container for primary keys.

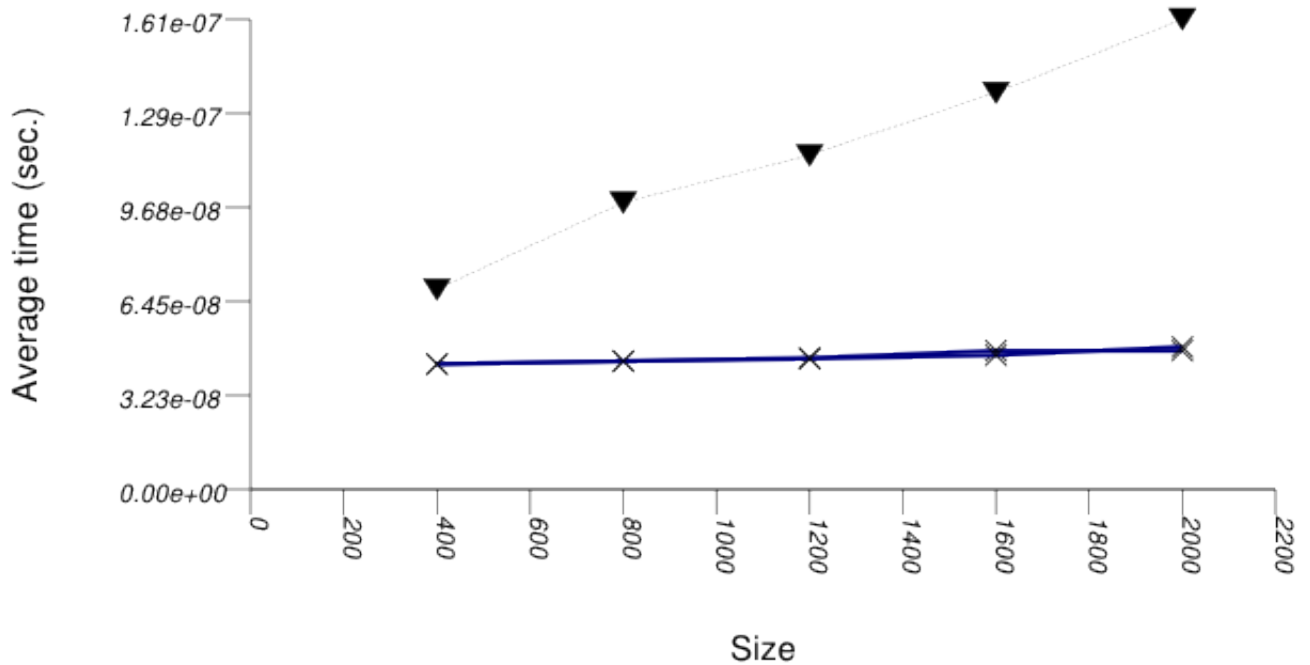

- ▼ n_hash_mmap
- × cc_hash_mask_exp_nea_lc_1div8_1div2_nsth_mmap
- × cc_hash_mask_exp_nea_lc_1div8_1div2_nsth_mmap_lu_mtf_set

The abbreviated names in the legend of the graphic above are instantiated with the types in the following table.

<i>Name/Instantiating Type</i>	<i>Parameter</i>	<i>Details</i>	<i>Parameter</i>	<i>Details</i>	<i>Parameter</i>	<i>Details</i>
n_hash_mmap						
std::tr1: : unordered _multimap						

<i>Name/Instantiating Type</i>	<i>Parameter</i>	<i>Details</i>	<i>Parameter</i>	<i>Details</i>	<i>Parameter</i>	<i>Details</i>	
rb_tree_mmap_lu_mtf_set							
cc_hash_table	Comb_Hash_Fn	direct_mask_range_hashing					
	Resize_Policy	hash_standard_resize_policy	Size_Policy	hash_exponential_size_policy			
			Trigger_Policy	hash_load_check_resize_trigger with $\alpha_{min} = 1/8$ and $\alpha_{max} = 1/2$			
Mapped	list_update	Update_Policy	lu_move_to_front_policy				
rb_tree_mmap_cc_hash_mask_exp_ldiv2_nsth_set							
cc_hash_table	Comb_Hash_Fn	direct_mask_range_hashing					
	Resize_Policy	hash_standard_resize_policy	Size_Policy	hash_exponential_size_policy			
			Trigger_Policy	hash_load_check_resize_trigger with $\alpha_{min} = 1/8$ and $\alpha_{max} = 1/2$			
	Mapped	cc_hash_table	Comb_Hash_Fn	direct_mask_range_hashing			
			Resize_Policy	hash_standard_resize_policy	Size_Policy	hash_exponential_size_policy	
					Trigger_Policy	hash_load_check_resize_trigger with $\alpha_{min} = 1/8$ and $\alpha_{max} = 1/2$	

22.4.2.3.3 Observations

See Observations::Mapping-Semantics Considerations.

22.4.2.3.4 Text insert with Small Secondary-to-Primary Key Ratios

22.4.2.3.4.1 Description

This test inserts a number of pairs into a container. The first item of each pair is a string from an arbitrary text [wickland96thirty], and the second is a uniform integer. The container is a "multimap" - it considers the first member of each pair as a primary key, and the second member of each pair as a secondary key. There are 400 distinct primary keys, and the ratio of secondary keys to primary keys ranges from 1 to 5.

The test measures the average insert-time as a function of the number of values inserted. For this library's containers, it inserts a primary key into the primary associative container, then a secondary key into the secondary associative container. For the native multimaps, it obtains a range using `std::equal_range`, and inserts a value only if it was not contained already.

It uses the test file: `performance/ext/pb_ds/multimap_text_insert_timing_large.cc`

The test checks the insert-time scalability of different "multimap" designs.

22.4.2.3.4.2 Results

The graphic below show the results for "multimaps" which use a tree-based container for primary keys.

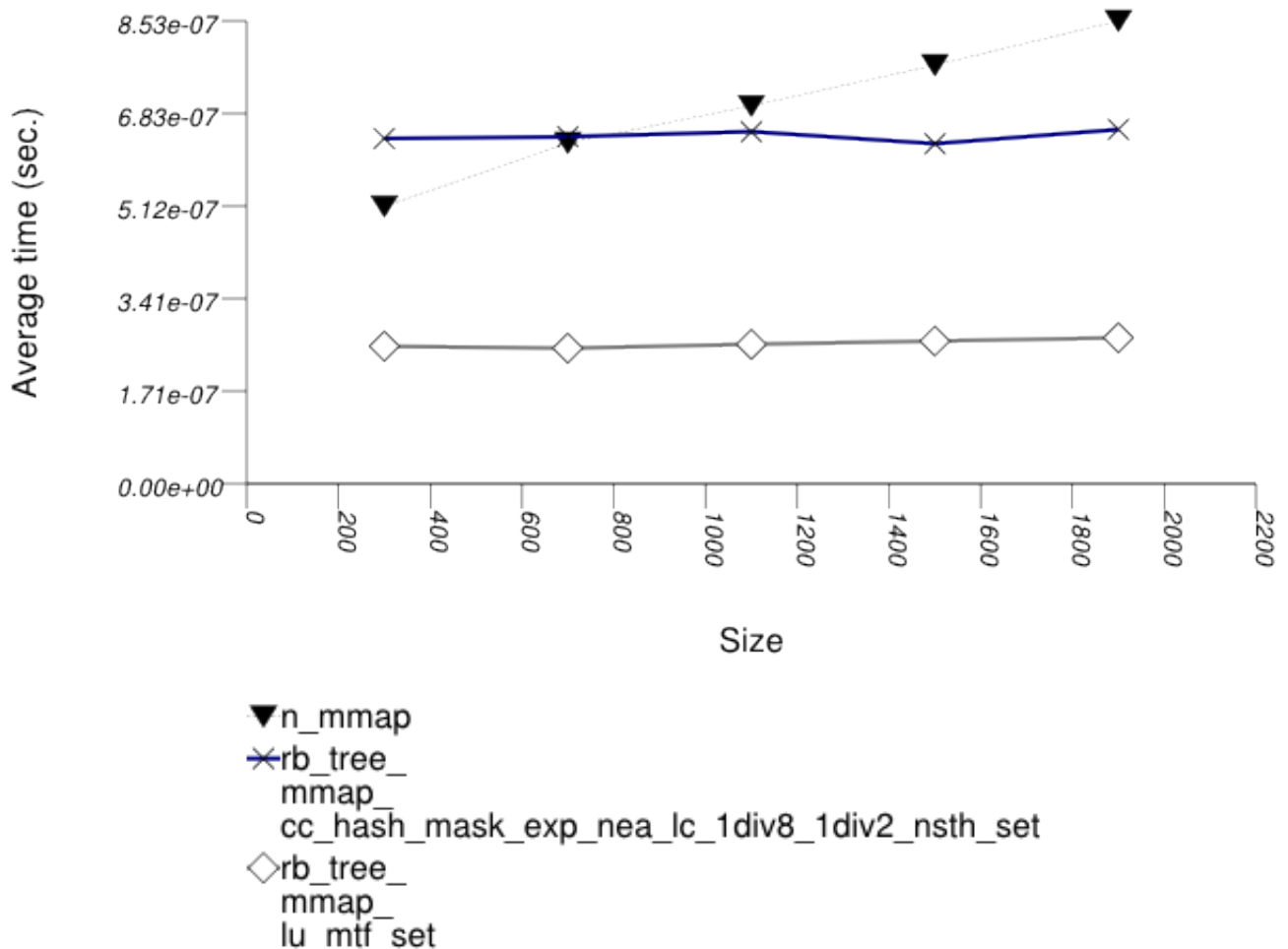

The abbreviated names in the legend of the graphic above are instantiated with the types in the following table.

<i>Name/Instantiating Type</i>	<i>Parameter</i>	<i>Details</i>	<i>Parameter</i>	<i>Details</i>	<i>Parameter</i>	<i>Details</i>
n_mmap						
std::multimap						
rb_tree_mmap_lu_mtf_set						
tree	Tag	rb_tree_tag				
	Node_Update	null_node_update				
	Mapped	list_update	Update_Policy	lu_move_to_front_policy		
rb_tree_mmap_cc_hash_mask_exp_ldiv2_nsth_set						
tree	Tag	rb_tree_tag				
	Node_Update	null_node_update				
	Mapped	cc_hash_table	Comb_Hash_Fn	direct_mask_range_hashing		
			Resize_Policy	hash_standard_resize_policy	Size_Policy	hash_exponential_size_policy
				Trigger_Policy	hash_load_check_resize_trigger with $\alpha_{\min} = 1/8$ and $\alpha_{\max} = 1/2$	

The graphic below show the results for "multimaps" which use a hash-based container for primary keys.

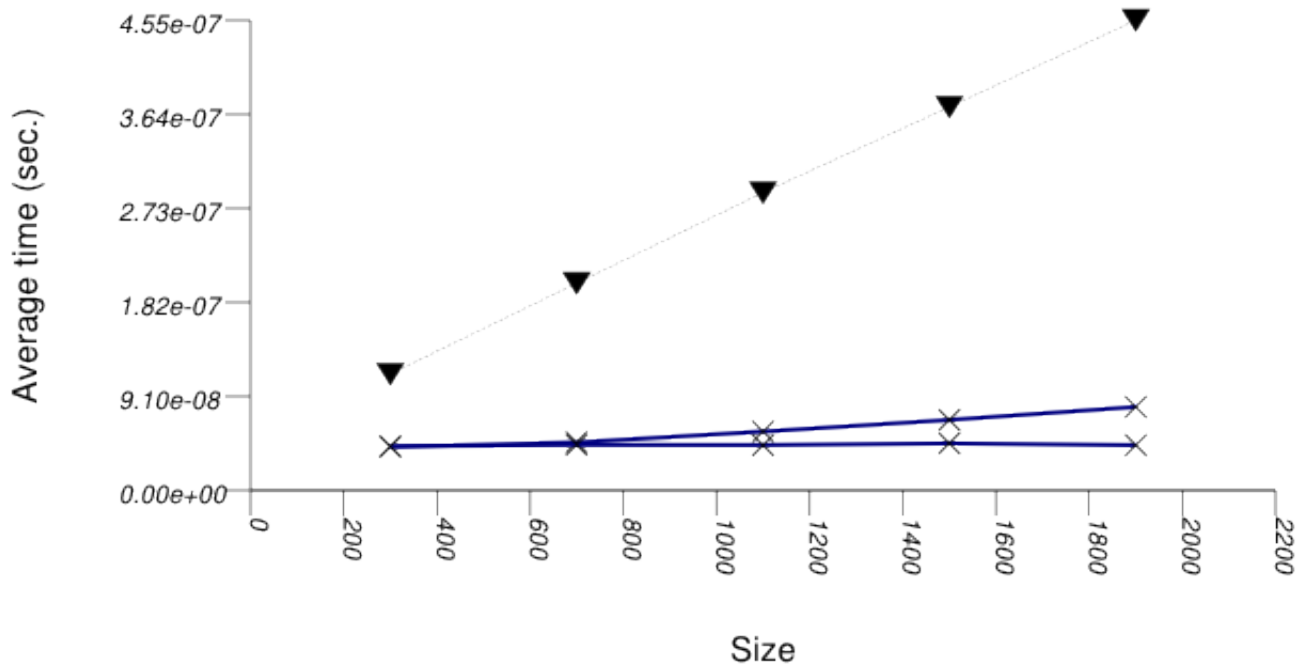

- ▼ n_hash_mmap
- × cc_hash_mask_exp_nea_lc_1div8_1div2_nsth_mmap_lu_mtf_set
- × cc_hash_mask_exp_nea_lc_1div8_1div2_nsth_mmap_cc_hash_mask_exp_nea_lc_1div8_1div2_nsth_set

The abbreviated names in the legend of the graphic above are instantiated with the types in the following table.

Name/Instantiating Type	Parameter	Details	Parameter	Details	Parameter	Details
n_hash_mmap						
std::tr1: : unordered_multimap						
rb_tree_mmap_lu_mtf_set						
cc_hash_table	Comb_Hash_Fn	direct_mask_range_hashing				
	Resize_Policy	hash_standard_resize_policy	Size_Policy	hash_exponential_size_policy		
Trigger_Policy			hash_load_check_resize_trigger with $\alpha_{min} = 1/8$ and $\alpha_{max} = 1/2$			

<i>Name/Instantiating Type</i>	<i>Parameter</i>	<i>Details</i>	<i>Parameter</i>	<i>Details</i>	<i>Parameter</i>	<i>Details</i>	
	Mapped	list_update	Update_Policy	lu_move_to_front_policy			
rb_tree_mmap_cc_hash_mask_exp_ldiv2_nsth_set							
cc_hash_table	Comb_Hash_Fn	direct_mask_range_hashing					
	Resize_Policy	hash_standard_resize_policy	Size_Policy	hash_exponential_size_policy			
			Trigger_Policy	hash_load_check_resize_trigger with $\alpha_{\min} = 1/8$ and $\alpha_{\max} = 1/2$			
	Mapped	cc_hash_table	Comb_Hash_Fn	direct_mask_range_hashing			
			Resize_Policy	hash_standard_resize_policy	Size_Policy	hash_exponential_size_policy	
					Trigger_Policy	hash_load_check_resize_trigger with $\alpha_{\min} = 1/8$ and $\alpha_{\max} = 1/2$	

22.4.2.3.4.3 Observations

See Observations::Mapping-Semantics Considerations.

22.4.2.3.5 Text insert with Small Secondary-to-Primary Key Ratios Memory Use

22.4.2.3.5.1 Description

This test inserts a number of pairs into a container. The first item of each pair is a string from an arbitrary text [wickland96thirty], and the second is a uniform integer. The container is a "multimap" - it considers the first member of each pair as a primary key, and the second member of each pair as a secondary key. There are 100 distinct primary keys, and the ratio of secondary keys to primary keys ranges to about 20.

The test measures the memory use as a function of the number of values inserted.

It uses the test file: performance/ext/pb_ds/multimap_text_insert_mem_usage_small.cc

The test checks the memory scalability of different "multimap" designs.

22.4.2.3.5.2 Results

The graphic below show the results for "multimaps" which use a tree-based container for primary keys.

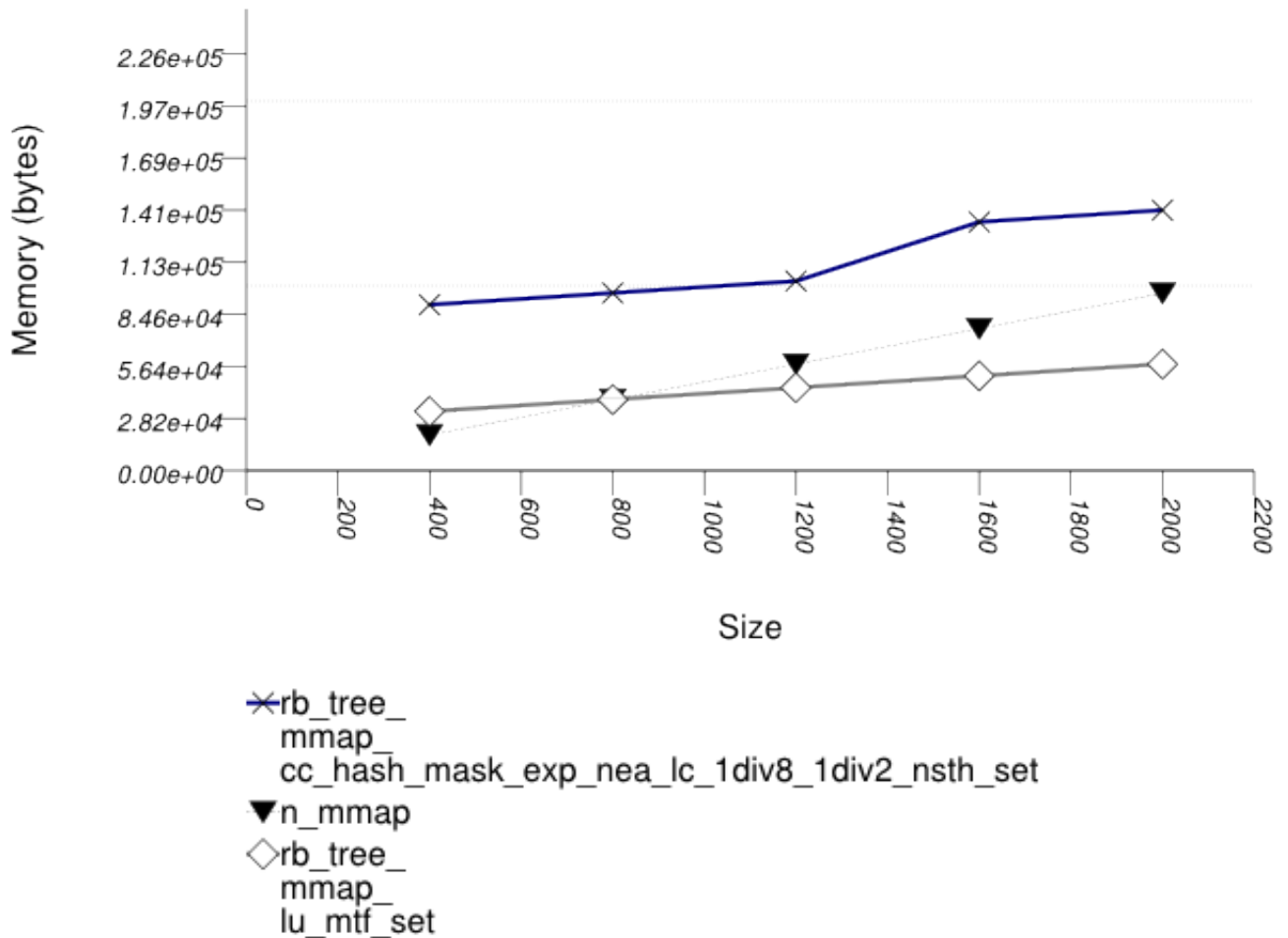

The abbreviated names in the legend of the graphic above are instantiated with the types in the following table.

Name/Instantiating Type	Parameter	Details	Parameter	Details	Parameter	Details
n_mmap						
std::multimap						
rb_tree_mmap_lu_mtf_set						
tree	Tag	rb_tree_tag				
	Node_Update	null_node_update				
	Mapped	list_update	Update_Policy	lu_move_to_front_policy		
rb_tree_mmap_cc_hash_mask_exp_1div2_nsth_set						
tree	Tag	rb_tree_tag				
	Node_Update	null_node_update				
	Mapped	cc_hash_table	Comb_Hash_Fn	direct_mask_range_hashing		

<i>Name/Instantiating Type</i>	<i>Parameter</i>	<i>Details</i>	<i>Parameter</i>	<i>Details</i>	<i>Parameter</i>	<i>Details</i>
			Resize_Policy	hash_standard_resize_policy	Size_Policy	hash_exponential_size_policy
					Trigger_Policy	hash_load_check_resize_trigger with $\alpha_{\min} = 1/8$ and $\alpha_{\max} = 1/2$

The graphic below show the results for "multimaps" which use a hash-based container for primary keys.

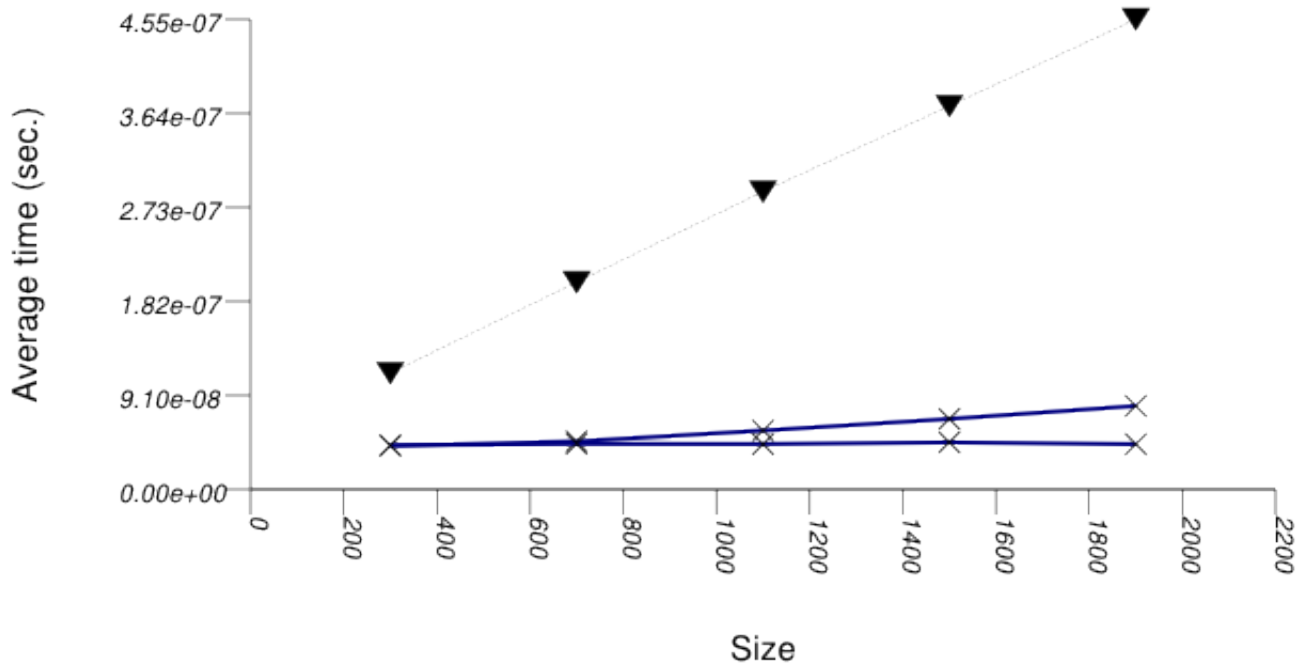

- ▼ n_hash_mmap
- × cc_hash_mask_exp_nea_lc_1div8_1div2_nsth_mmap_lu_mtf_set
- × cc_hash_mask_exp_nea_lc_1div8_1div2_nsth_mmap_cc_hash_mask_exp_nea_lc_1div8_1div2_nsth_set

The abbreviated names in the legend of the graphic above are instantiated with the types in the following table.

<i>Name/Instantiating Type</i>	<i>Parameter</i>	<i>Details</i>	<i>Parameter</i>	<i>Details</i>	<i>Parameter</i>	<i>Details</i>
n_hash_mmap						
std::tr1: : unordered _multimap						

<i>Name/Instantiating Type</i>	<i>Parameter</i>	<i>Details</i>	<i>Parameter</i>	<i>Details</i>	<i>Parameter</i>	<i>Details</i>	
rb_tree_mmap_lu_mtf_set							
cc_hash_table	Comb_Hash_Fn	direct_mask_range_hashing					
	Resize_Policy	hash_standard_resize_policy	Size_Policy	hash_exponential_size_policy			
			Trigger_Policy	hash_load_check_resize_trigger with $\alpha_{min} = 1/8$ and $\alpha_{max} = 1/2$			
Mapped	list_update	Update_Policy	lu_move_to_front_policy				
rb_tree_mmap_cc_hash_mask_exp_ldiv2_nsth_set							
cc_hash_table	Comb_Hash_Fn	direct_mask_range_hashing					
	Resize_Policy	hash_standard_resize_policy	Size_Policy	hash_exponential_size_policy			
			Trigger_Policy	hash_load_check_resize_trigger with $\alpha_{min} = 1/8$ and $\alpha_{max} = 1/2$			
	Mapped	cc_hash_table	Comb_Hash_Fn	direct_mask_range_hashing			
			Resize_Policy	hash_standard_resize_policy	Size_Policy	hash_exponential_size_policy	
					Trigger_Policy	hash_load_check_resize_trigger with $\alpha_{min} = 1/8$ and $\alpha_{max} = 1/2$	

22.4.2.3.5.3 Observations

See Observations::Mapping-Semantics Considerations.

22.4.2.3.6 Text insert with Small Secondary-to-Primary Key Ratios Memory Use

22.4.2.3.6.1 Description

This test inserts a number of pairs into a container. The first item of each pair is a string from an arbitrary text [wickland96thirty], and the second is a uniform integer. The container is a "multimap" - it considers the first member of each pair as a primary key, and the second member of each pair as a secondary key. There are 100 distinct primary keys, and the ratio of secondary keys to primary keys ranges to about 20.

The test measures the memory use as a function of the number of values inserted.

It uses the test file: `performance/ext/pb_ds/multimap_text_insert_mem_usage_large.cc`

The test checks the memory scalability of different "multimap" designs.

22.4.2.3.6.2 Results

The graphic below show the results for "multimaps" which use a tree-based container for primary keys.

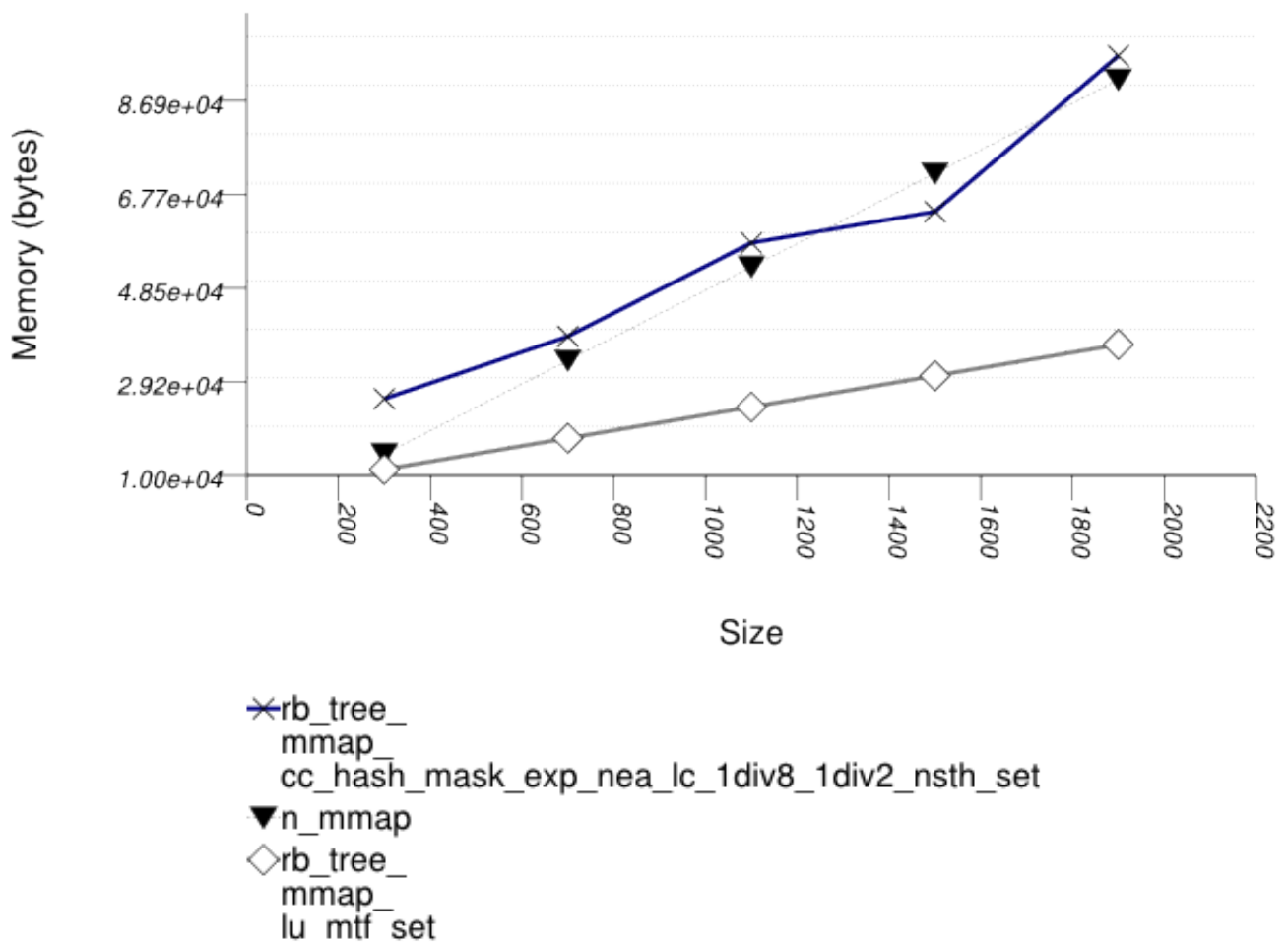

The abbreviated names in the legend of the graphic above are instantiated with the types in the following table.

Name/Instantiating Type	Parameter	Details	Parameter	Details	Parameter	Details
n_mmap						
std::multimap						

<i>Name/Instantiating Type</i>	<i>Parameter</i>	<i>Details</i>	<i>Parameter</i>	<i>Details</i>	<i>Parameter</i>	<i>Details</i>
rb_tree_mmap_lu_mtf_set						
tree	Tag	rb_tree_tag				
	Node_Update	null_node_update				
	Mapped	list_update	Update_Policy	lu_move_to_front_policy		
rb_tree_mmap_cc_hash_mask_exp_ldiv2_nsth_set						
tree	Tag	rb_tree_tag				
	Node_Update	null_node_update				
	Mapped	cc_hash_table	Comb_Hash_Fn	direct_mask_range_hashing		
			Resize_Policy	hash_standard_resize_policy	Size_Policy	hash_exponential_size_policy
				Trigger_Policy	hash_load_check_resize_trigger with $\alpha_{\min} = 1/8$ and $\alpha_{\max} = 1/2$	

The graphic below show the results for "multimaps" which use a hash-based container for primary keys.

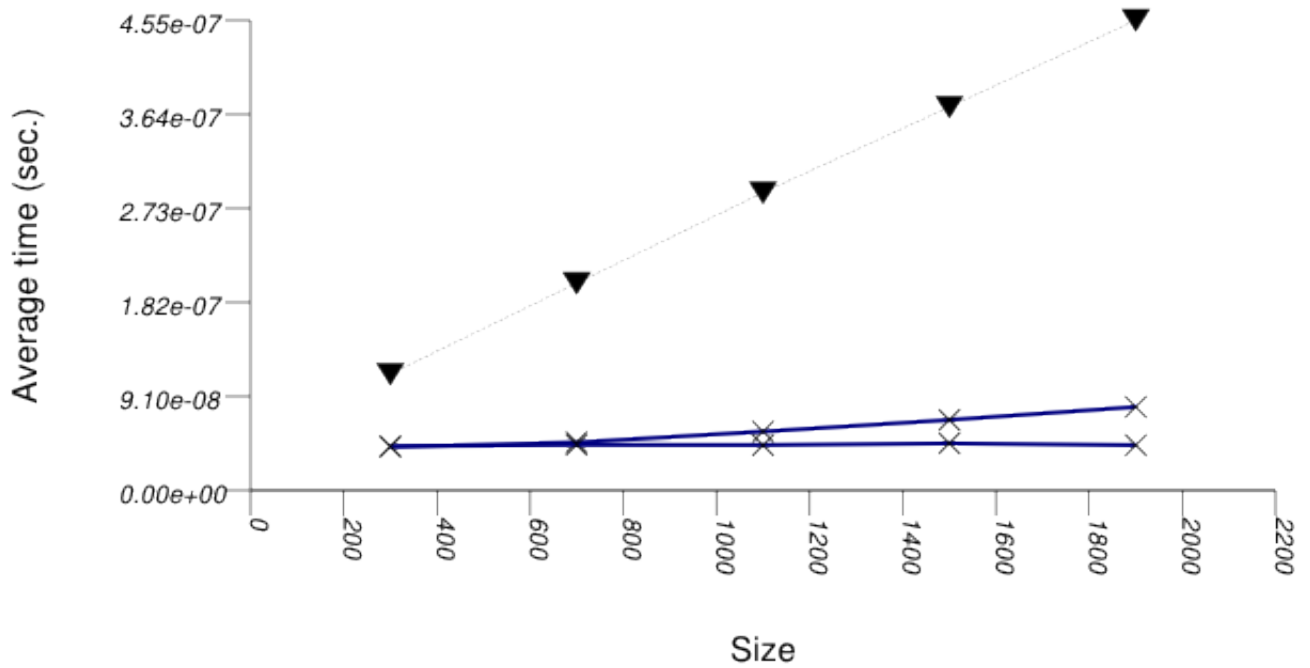

- ▼ n_hash_mmap
- × cc_hash_mask_exp_nea_lc_1div8_1div2_nsth_mmap_lu_mtf_set
- × cc_hash_mask_exp_nea_lc_1div8_1div2_nsth_mmap_cc_hash_mask_exp_nea_lc_1div8_1div2_nsth_set

The abbreviated names in the legend of the graphic above are instantiated with the types in the following table.

<i>Name/Instantiating Type</i>	<i>Parameter</i>	<i>Details</i>	<i>Parameter</i>	<i>Details</i>	<i>Parameter</i>	<i>Details</i>
n_hash_mmap						
std::tr1: unordered_multimap						
rb_tree_mmap_lu_mtf_set						
cc_hash_table	Comb_Hash_Fn	direct_mask_range_hashing				
	Resize_Policy	hash_standard_resize_policy	Size_Policy	hash_exponential_size_policy		
Trigger_Policy			hash_load_check_resize_trigger with $\alpha_{min} = 1/8$ and $\alpha_{max} = 1/2$			

<i>Name/Instantiating Type</i>	<i>Parameter</i>	<i>Details</i>	<i>Parameter</i>	<i>Details</i>	<i>Parameter</i>	<i>Details</i>	
	Mapped	list_update	Update_Policy	lu_move_to_front_policy			
rb_tree_mmap_cc_hash_mask_exp_ldiv2_nsth_set							
cc_hash_table	Comb_Hash_Fn	direct_mask_range_hashing					
	Resize_Policy	hash_standard_resize_policy	Size_Policy	hash_exponential_size_policy			
			Trigger_Policy	hash_load_check_resize_trigger with $\alpha_{\min} = 1/8$ and $\alpha_{\max} = 1/2$			
	Mapped	cc_hash_table	Comb_Hash_Fn	direct_mask_range_hashing			
			Resize_Policy	hash_standard_resize_policy	Size_Policy	hash_exponential_size_policy	
					Trigger_Policy	hash_load_check_resize_trigger with $\alpha_{\min} = 1/8$ and $\alpha_{\max} = 1/2$	

22.4.2.3.6.3 Observations

See Observations::Mapping-Semantics Considerations.

22.4.2.4 Priority Queue

22.4.2.4.1 Text push

22.4.2.4.1.1 Description

This test inserts a number of values with keys from an arbitrary text ([wickland96thirty]) into a container using push. It measures the average time for push as a function of the number of values pushed.

It uses the test file: performance/ext/pb_ds/priority_queue_text_push_timing.cc

The test checks the effect of different underlying data structures.

22.4.2.4.1.2 Results

The two graphics below show the results for the native priority_queues and this library's priority_queues.

The graphic immediately below shows the results for the native priority_queue type instantiated with different underlying container types versus several different versions of library's priority_queues.

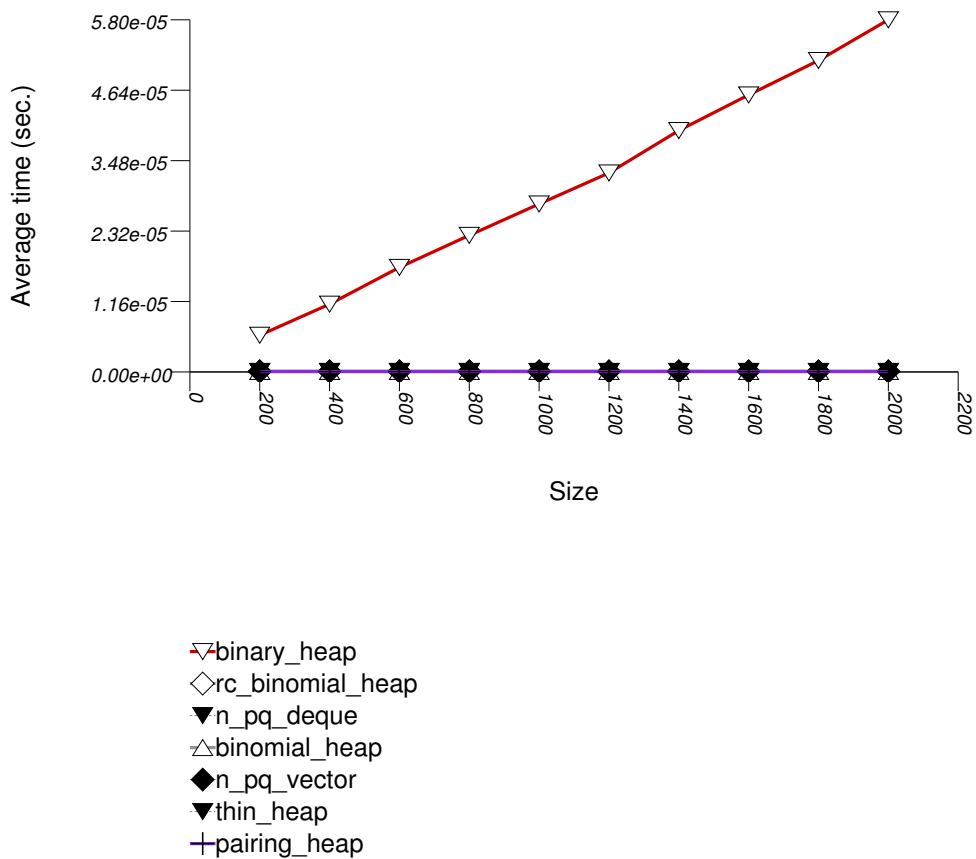

The abbreviated names in the legend of the graphic above are instantiated with the types in the following table.

<i>Name/Instantiating Type</i>	<i>Parameter</i>	<i>Details</i>
n_pq_vector		
std::priority_queue	Sequence	std::vector
n_pq_deque		
std::priority_queue	Sequence	std::deque
binary_heap		
priority_queue	Tag	binary_heap_tag
binomial_heap		
priority_queue	Tag	binomial_heap_tag
rc_binomial_heap		
priority_queue	Tag	rc_binomial_heap_tag
thin_heap		
priority_queue	Tag	thin_heap_tag
pairing_heap		
priority_queue	Tag	pairing_heap_tag

The graphic below shows the results for the binary-heap based native priority queues and this library's pairing-heap priority-queue data structures.

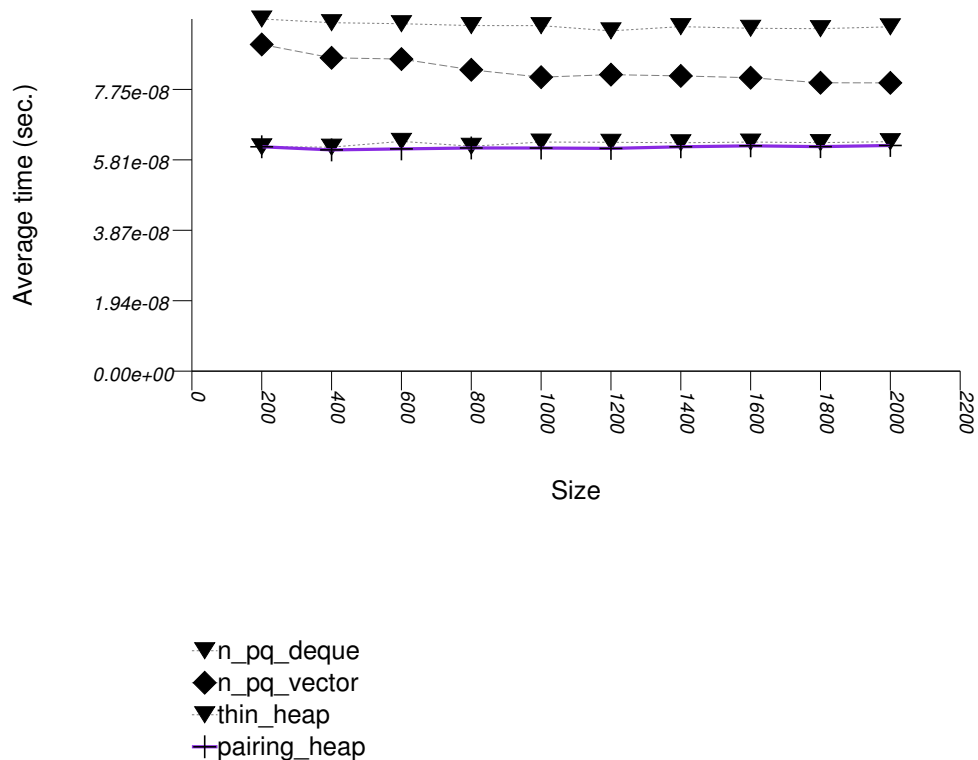

The abbreviated names in the legend of the graphic above are instantiated with the types in the following table.

<i>Name/Instantiating Type</i>	<i>Parameter</i>	<i>Details</i>
n_pq_vector		
std::priority_queue	Sequence	std::vector
n_pq_deque		
std::priority_queue	Sequence	std::deque
thin_heap		
priority_queue	Tag	thin_heap_tag
pairing_heap		
priority_queue	Tag	pairing_heap_tag

22.4.2.4.1.3 Observations

Pairing heaps (priority_queue with Tag = pairing_heap_tag) are the most suited for sequences of push and pop operations of non-primitive types (e.g. std::strings). (See Priority Queue Text push and pop Timing Test.) They are less constrained than binomial heaps, e.g., and since they are node-based, they outperform binary heaps. (See Priority Queue Random Integer push Timing Test for the case of primitive types.)

The standard's priority queues do not seem to perform well in this case: the std::vector implementation needs to perform a logarithmic sequence of string operations for each operation, and the deque implementation is possibly hampered by its need to manipulate a relatively-complex type (deques support a O(1) push_front, even though it is not used by std::priority_queue.)

22.4.2.4.2 Text push and pop

22.4.2.4.2.1 Description

This test inserts a number of values with keys from an arbitrary text ([wickland96thirty]) into a container using push, then removes them using pop. It measures the average time for push as a function of the number of values.

It uses the test file: performance/ext/pb_ds/priority_queue_text_push_pop_timing.cc

The test checks the effect of different underlying data structures.

22.4.2.4.2.2 Results

The two graphics below show the results for the native `priority_queues` and this library's `priority_queues`.

The graphic immediately below shows the results for the native `priority_queue` type instantiated with different underlying container types versus several different versions of library's `priority_queues`.

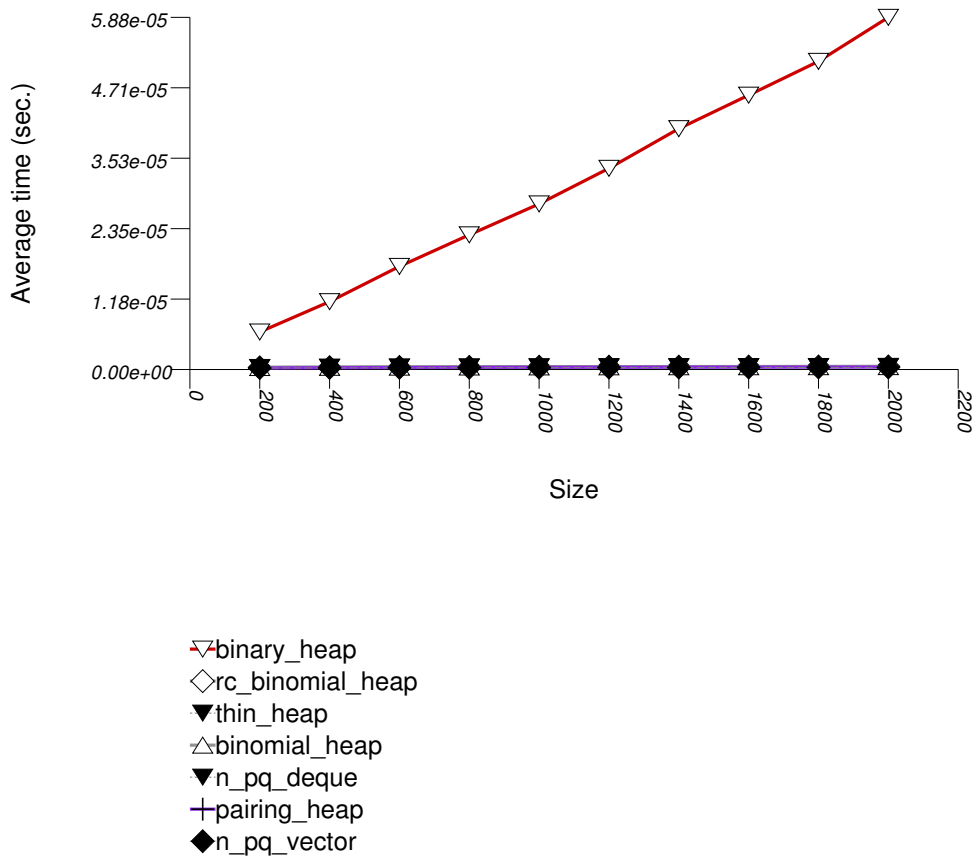

The abbreviated names in the legend of the graphic above are instantiated with the types in the following table.

<i>Name/Instantiating Type</i>	<i>Parameter</i>	<i>Details</i>
<code>n_pq_vector</code>		
<code>std::priority_queue</code>	Sequence	<code>std::vector</code>
<code>n_pq_deque</code>		
<code>std::priority_queue</code>	Sequence	<code>std::deque</code>
<code>binary_heap</code>		
<code>priority_queue</code>	Tag	<code>binary_heap_tag</code>
<code>binomial_heap</code>		
<code>priority_queue</code>	Tag	<code>binomial_heap_tag</code>
<code>rc_binomial_heap</code>		
<code>priority_queue</code>	Tag	<code>rc_binomial_heap_tag</code>
<code>thin_heap</code>		
<code>priority_queue</code>	Tag	<code>thin_heap_tag</code>
<code>pairing_heap</code>		
<code>priority_queue</code>	Tag	<code>pairing_heap_tag</code>

The graphic below shows the results for the native priority queues and this library's pairing-heap priority_queue data structures.

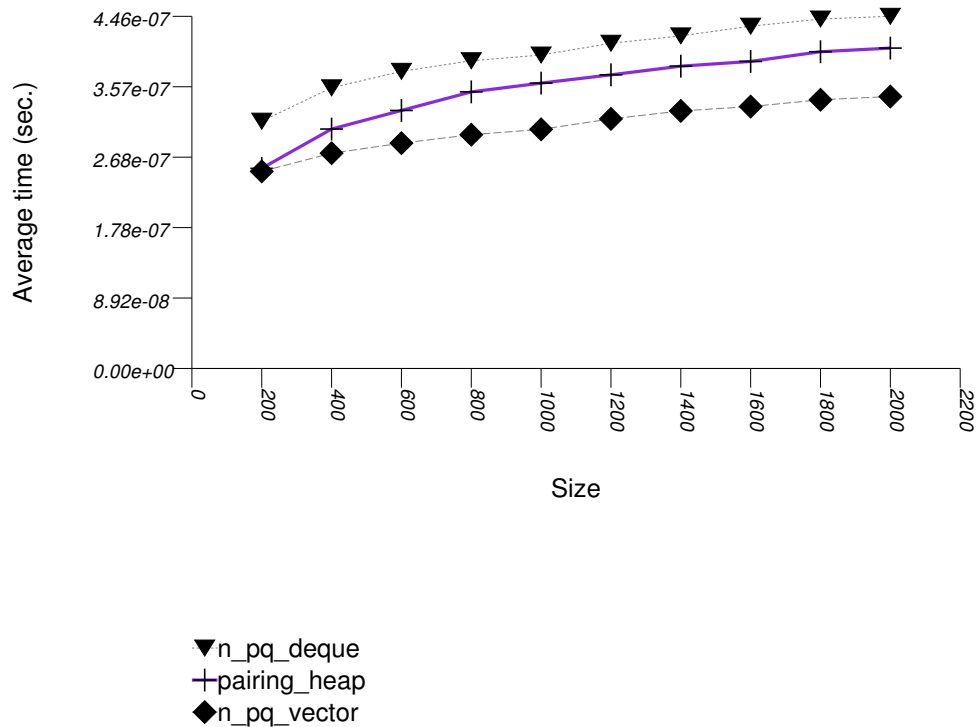

The abbreviated names in the legend of the graphic above are instantiated with the types in the following table.

<i>Name/Instantiating Type</i>	<i>Parameter</i>	<i>Details</i>
n_pq_vector		
std::priority_queue adapting std::vector	Sequence	std::vector
n_pq_deque		
std::priority_queue	Sequence	std::deque
pairing_heap		
priority_queue	Tag	pairing_heap_tag

22.4.2.4.2.3 Observations

These results are very similar to Priority Queue Text push Timing Test. As stated there, pairing heaps (priority_queue with Tag = pairing_heap_tag) are most suited for push and pop sequences of non-primitive types such as strings. Observing these two tests, one can note that a pairing heap outperforms the others in terms of push operations, but equals binary heaps (priority_queue with Tag = binary_heap_tag) if the number of push and pop operations is equal. As the number of pop operations is at most equal to the number of push operations, pairing heaps are better in this case. See Priority Queue Random Integer push and pop Timing Test for a case which is different.

22.4.2.4.3 Integer push

22.4.2.4.3.1 Description

This test inserts a number of values with integer keys into a container using push. It measures the average time for push as a function of the number of values.

It uses the test file: `performance/ext/pb_ds/priority_queue_random_int_push_timing.cc`

The test checks the effect of different underlying data structures.

22.4.2.4.3.2 Results

The two graphics below show the results for the native `priority_queues` and this library's `priority_queues`.

The graphic immediately below shows the results for the native `priority_queue` type instantiated with different underlying container types versus several different versions of library's `priority_queues`.

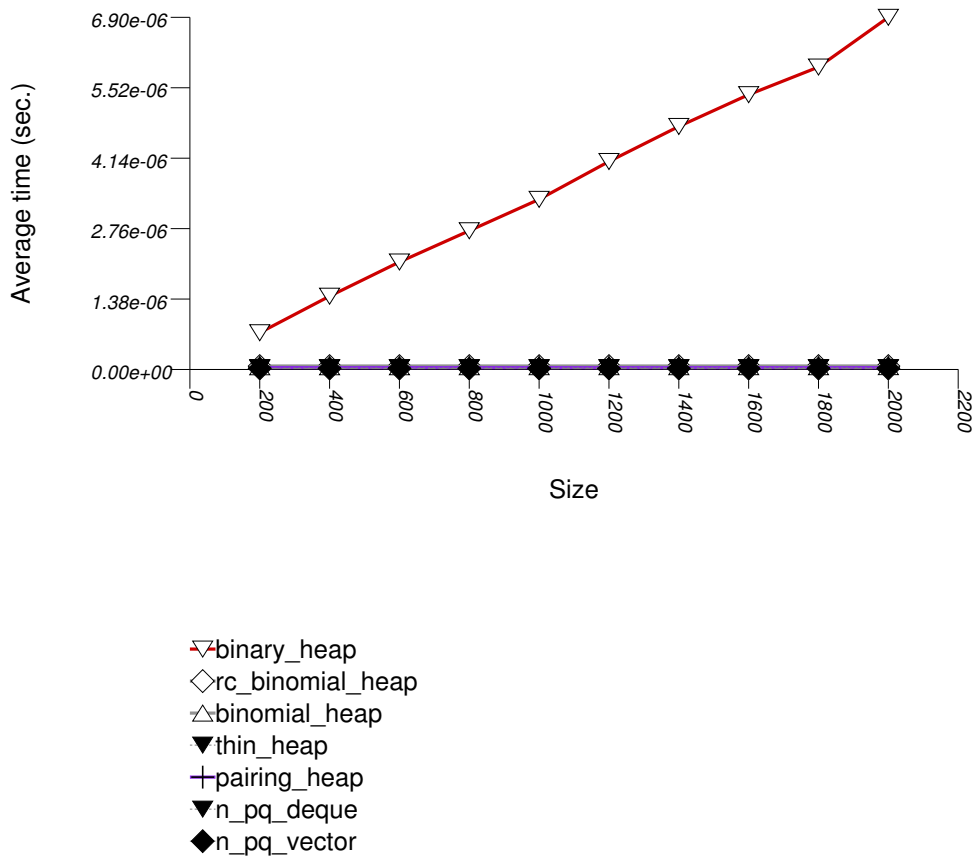

The abbreviated names in the legend of the graphic above are instantiated with the types in the following table.

<i>Name/Instantiating Type</i>	<i>Parameter</i>	<i>Details</i>
<code>n_pq_vector</code>		
<code>std::priority_queue</code>	Sequence	<code>std::vector</code>
<code>n_pq_deque</code>		
<code>std::priority_queue</code>	Sequence	<code>std::deque</code>
<code>binary_heap</code>		
<code>priority_queue</code>	Tag	<code>binary_heap_tag</code>
<code>binomial_heap</code>		
<code>priority_queue</code>	Tag	<code>binomial_heap_tag</code>
<code>rc_binomial_heap</code>		
<code>priority_queue</code>	Tag	<code>rc_binomial_heap_tag</code>
<code>thin_heap</code>		
<code>priority_queue</code>	Tag	<code>thin_heap_tag</code>
<code>pairing_heap</code>		
<code>priority_queue</code>	Tag	<code>pairing_heap_tag</code>

The graphic below shows the results for the binary-heap based native priority queues and this library's `priority_queue` data structures.

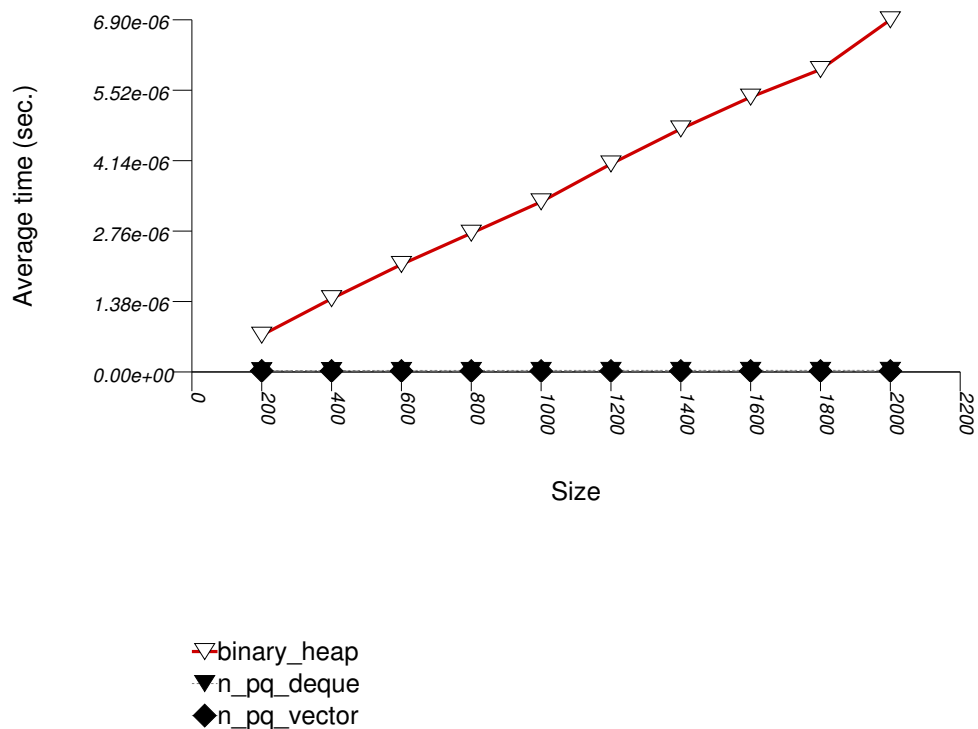

The abbreviated names in the legend of the graphic above are instantiated with the types in the following table.

<i>Name/Instantiating Type</i>	<i>Parameter</i>	<i>Details</i>
n_pq_vector		
std::priority_queue adapting std::vector	Sequence	std::vector
n_pq_deque		
std::priority_queue	Sequence	std::deque
binary_heap		
priority_queue	Tag	binary_heap_tag

22.4.2.4.3.3 Observations

Binary heaps are the most suited for sequences of push and pop operations of primitive types (e.g. ints). They are less constrained than any other type, and since it is very efficient to store such types in arrays, they outperform even pairing heaps. (See Priority Queue Text push Timing Test for the case of non-primitive types.)

22.4.2.4.4 Integer push

22.4.2.4.4.1 Description

This test inserts a number of values with integer keys into a container using `push`, then removes them using `pop`. It measures the average time for `push` and `pop` as a function of the number of values.

It uses the test file: `performance/ext/pb_ds/priority_queue_random_int_push_pop_timing.cc`

The test checks the effect of different underlying data structures.

22.4.2.4.4.2 Results

The graphic immediately below shows the results for the native `priority_queue` type instantiated with different underlying container types versus several different versions of library's `priority_queues`.

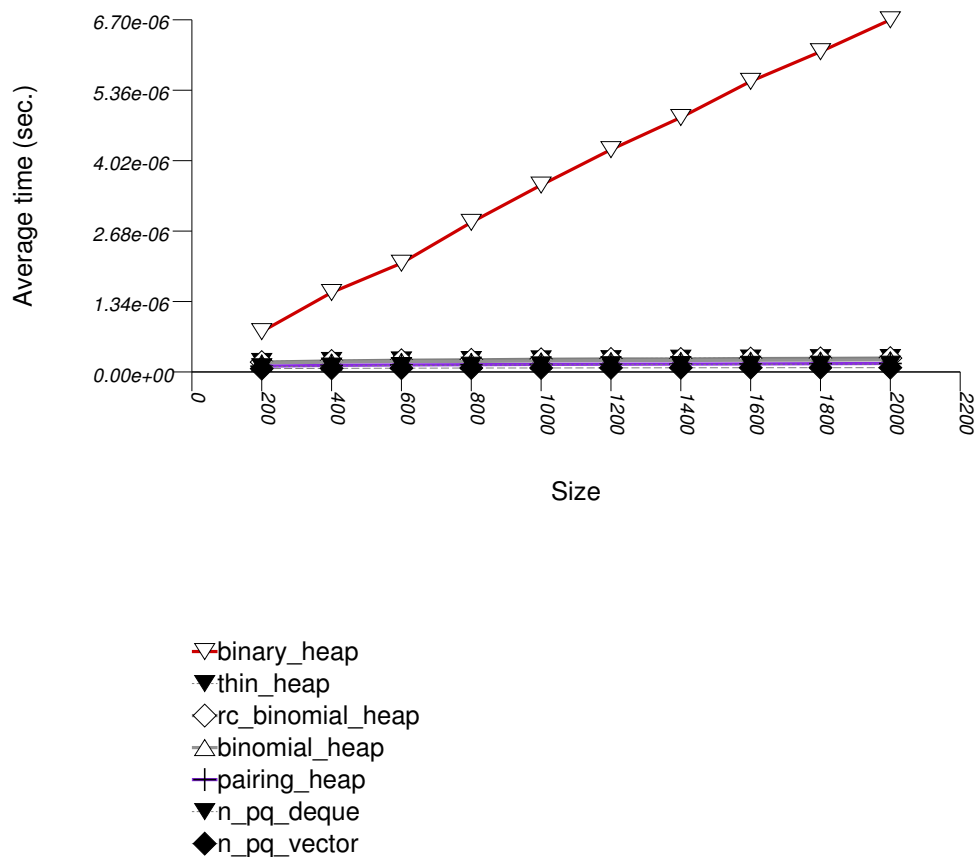

The abbreviated names in the legend of the graphic above are instantiated with the types in the following table.

<i>Name/Instantiating Type</i>	<i>Parameter</i>	<i>Details</i>
n_pq_vector		
std::priority_queue	Sequence	std::vector
n_pq_deque		
std::priority_queue	Sequence	std::deque
binary_heap		
priority_queue	Tag	binary_heap_tag
binomial_heap		
priority_queue	Tag	binomial_heap_tag
rc_binomial_heap		
priority_queue	Tag	rc_binomial_heap_tag
thin_heap		
priority_queue	Tag	thin_heap_tag
pairing_heap		
priority_queue	Tag	pairing_heap_tag

22.4.2.4.4.3 Observations

Binary heaps are the most suited for sequences of `push` and `pop` operations of primitive types (e.g. ints). This is explained in Priority Queue Random Int `push` Timing Test. (See Priority Queue Text `push` Timing Test for the case of primitive types.)

At first glance it seems that the standard's vector-based priority queue is approximately on par with this library's corresponding priority queue. There are two differences however:

1. The standard's priority queue does not downsize the underlying vector (or deque) as the priority queue becomes smaller (see Priority Queue Text `pop` Memory Use Test). It is therefore gaining some speed at the expense of space.

- From Priority Queue Random Integer `push` and `pop` Timing Test, it seems that the standard's priority queue is slower in terms of `push` operations. Since the number of `pop` operations is at most that of `push` operations, the test here is the "best" for the standard's priority queue.

22.4.2.4.5 Text pop Memory Use

22.4.2.4.5.1 Description

This test inserts a number of values with keys from an arbitrary text ([wickland96thirty]) into a container, then pops them until only one is left in the container. It measures the memory use as a function of the number of values pushed to the container.

It uses the test file: `performance/ext/pb_ds/priority_queue_text_pop_mem_usage.cc`

The test checks the effect of different underlying data structures.

22.4.2.4.5.2 Results

The graphic immediately below shows the results for the native `priority_queue` type instantiated with different underlying container types versus several different versions of library's `priority_queues`.

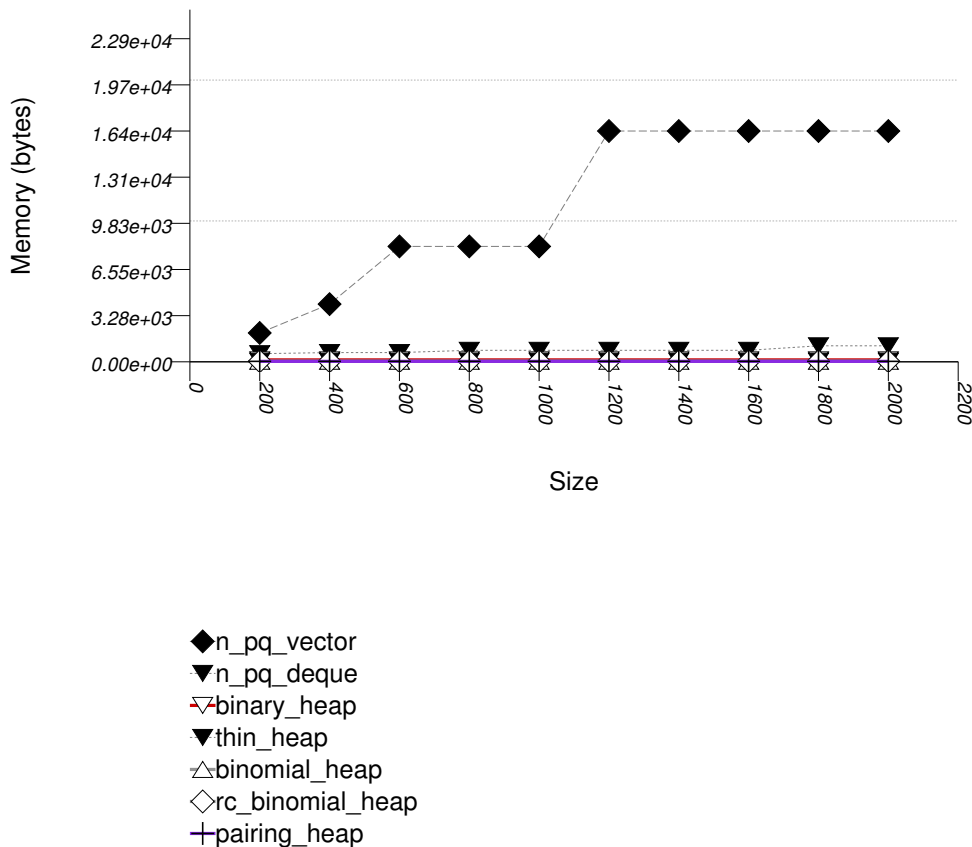

The abbreviated names in the legend of the graphic above are instantiated with the types in the following table.

Name/Instantiating Type	Parameter	Details
n_pq_vector		
std::priority_queue	Sequence	std::vector
n_pq_deque		
std::priority_queue	Sequence	std::deque
binary_heap		
priority_queue	Tag	binary_heap_tag

<i>Name/Instantiating Type</i>	<i>Parameter</i>	<i>Details</i>
<code>binomial_heap</code>		
<code>priority_queue</code>	Tag	<code>binomial_heap_tag</code>
<code>rc_binomial_heap</code>		
<code>priority_queue</code>	Tag	<code>rc_binomial_heap_tag</code>
<code>thin_heap</code>		
<code>priority_queue</code>	Tag	<code>thin_heap_tag</code>
<code>pairing_heap</code>		
<code>priority_queue</code>	Tag	<code>pairing_heap_tag</code>

22.4.2.4.5.3 Observations

The priority queue implementations (excluding the standard's) use memory proportionally to the number of values they hold: node-based implementations (e.g., a pairing heap) do so naturally; this library's binary heap de-allocates memory when a certain lower threshold is exceeded.

Note from Priority Queue Text `push` and `pop` Timing Test and Priority Queue Random Integer `push` and `pop` Timing Test that this does not impede performance compared to the standard's priority queues.

See Hash-Based Erase Memory Use Test for a similar phenomenon regarding priority queues.

22.4.2.4.6 Text join

22.4.2.4.6.1 Description

This test inserts a number of values with keys from an arbitrary text ([wickland96thirty]) into two containers, then merges the containers. It uses `join` for this library's priority queues; for the standard's priority queues, it successively pops values from one container and pushes them into the other. The test measures the average time as a function of the number of values.

It uses the test file: `performance/ext/pb_ds/priority_queue_text_join_timing.cc`

The test checks the effect of different underlying data structures.

22.4.2.4.6.2 Results

The graphic immediately below shows the results for the native `priority_queue` type instantiated with different underlying container types versus several different versions of library's priority_queues.

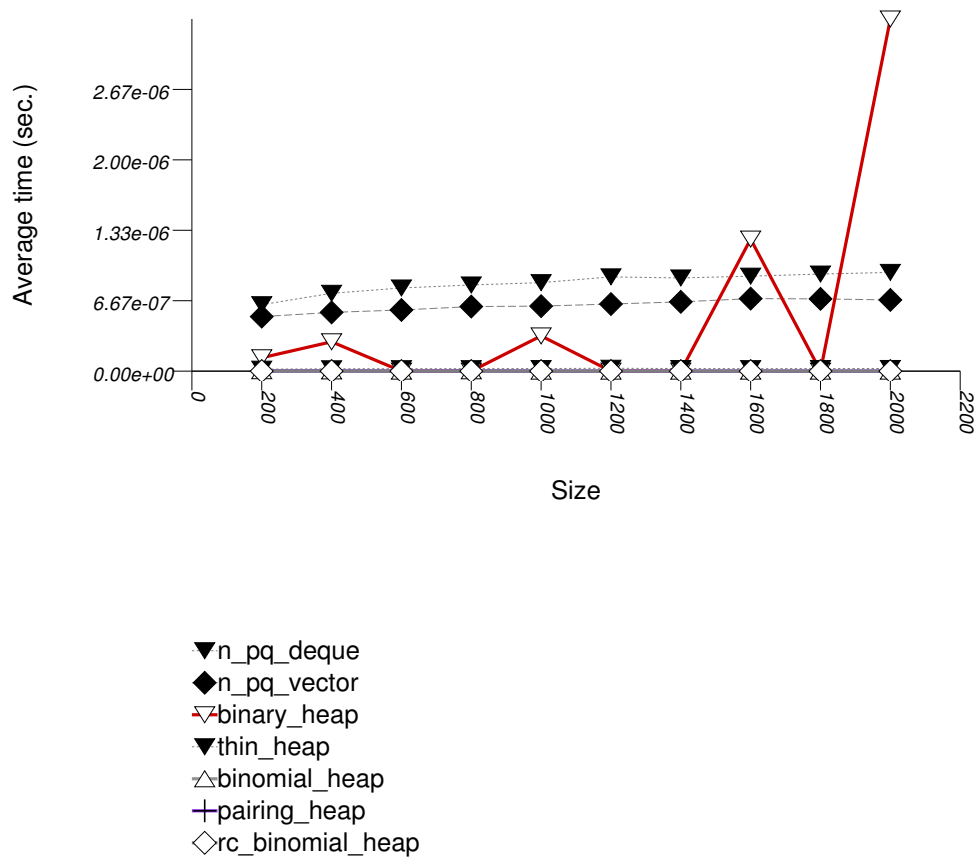

The abbreviated names in the legend of the graphic above are instantiated with the types in the following table.

<i>Name/Instantiating Type</i>	<i>Parameter</i>	<i>Details</i>
<code>n_pq_vector</code>		
<code>std::priority_queue</code>	Sequence	<code>std::vector</code>
<code>n_pq_deque</code>		
<code>std::priority_queue</code>	Sequence	<code>std::deque</code>
<code>binary_heap</code>		
<code>priority_queue</code>	Tag	<code>binary_heap_tag</code>
<code>binomial_heap</code>		
<code>priority_queue</code>	Tag	<code>binomial_heap_tag</code>
<code>rc_binomial_heap</code>		
<code>priority_queue</code>	Tag	<code>rc_binomial_heap_tag</code>
<code>thin_heap</code>		
<code>priority_queue</code>	Tag	<code>thin_heap_tag</code>
<code>pairing_heap</code>		
<code>priority_queue</code>	Tag	<code>pairing_heap_tag</code>

22.4.2.4.6.3 Observations

In this test the node-based heaps perform `join` in either logarithmic or constant time. The binary heap requires linear time, since the well-known heapify algorithm [clrs2001] is linear.

It would be possible to apply the heapify algorithm to the standard containers, if they would support iteration (which they don't). Barring iterators, it is still somehow possible to perform linear-time merge on a `std::vector`-based standard priority queue, using `top()` and `size()` (since they are enough to expose the underlying array), but this is impossible for a `std::deque`-based standard priority queue. Without heapify, the cost is super-linear.

22.4.2.4.7 Text modify Up

22.4.2.4.7.1 Description

This test inserts a number of values with keys from an arbitrary text ([wickland96thirty]) into into a container then modifies each one "up" (i.e., it makes it larger). It uses `modify` for this library's priority queues; for the standard's priority queues, it pops values from a container until it reaches the value that should be modified, then pushes values back in. It measures the average time for `modify` as a function of the number of values.

It uses the test file: `performance/ext/pb_ds/priority_queue_text_modify_up_timing.cc`

The test checks the effect of different underlying data structures for graph algorithms settings. Note that making an arbitrary value larger (in the sense of the priority queue's comparison functor) corresponds to decrease-key in standard graph algorithms [clrs2001].

22.4.2.4.7.2 Results

The two graphics below show the results for the native `priority_queues` and this library's `priority_queues`.

The graphic immediately below shows the results for the native `priority_queue` type instantiated with different underlying container types versus several different versions of library's `priority_queues`.

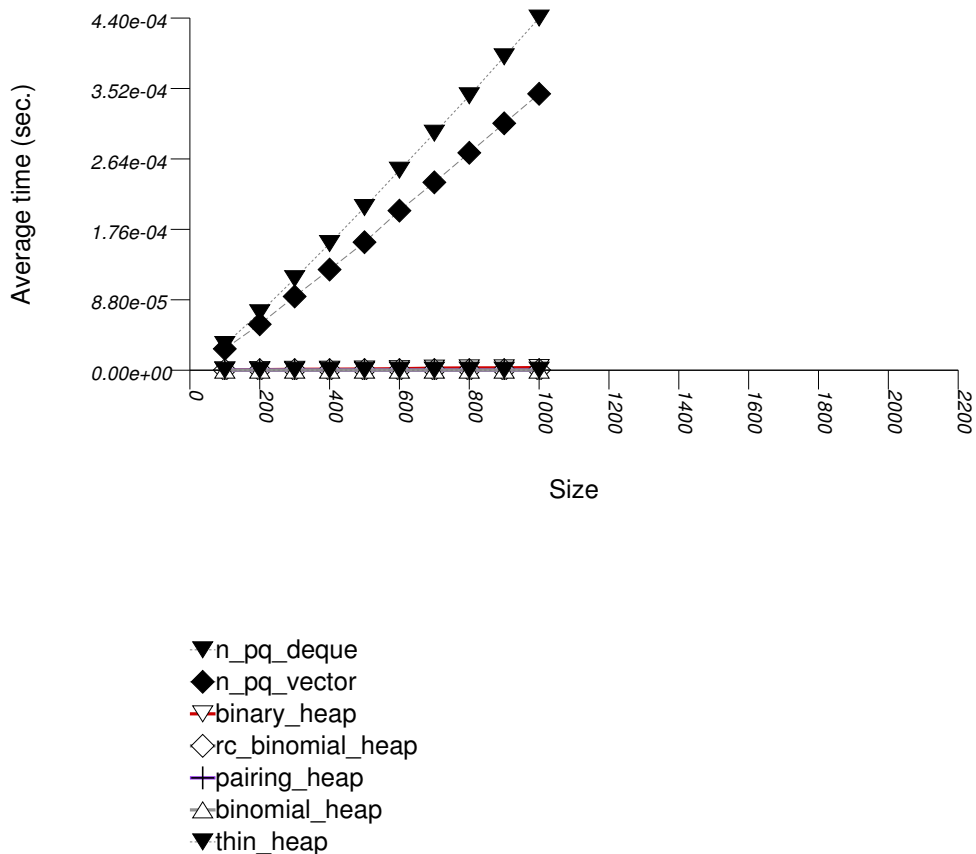

The abbreviated names in the legend of the graphic above are instantiated with the types in the following table.

<i>Name/Instantiating Type</i>	<i>Parameter</i>	<i>Details</i>
<code>n_pq_vector</code>		
<code>std::priority_queue</code>	Sequence	<code>std::vector</code>
<code>n_pq_deque</code>		
<code>std::priority_queue</code>	Sequence	<code>std::deque</code>

<i>Name/Instantiating Type</i>	<i>Parameter</i>	<i>Details</i>
binary_heap		
priority_queue	Tag	binary_heap_tag
binomial_heap		
priority_queue	Tag	binomial_heap_tag
rc_binomial_heap		
priority_queue	Tag	rc_binomial_heap_tag
thin_heap		
priority_queue	Tag	thin_heap_tag
pairing_heap		
priority_queue	Tag	pairing_heap_tag

The graphic below shows the results for the native priority queues and this library's pairing and thin heap priority_queue data structures.

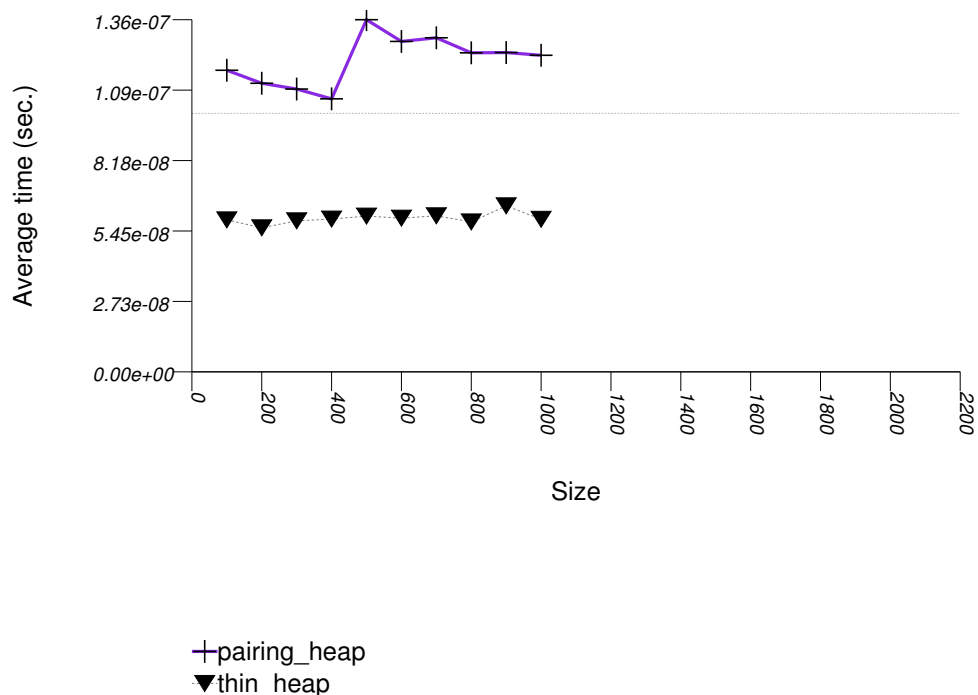

The abbreviated names in the legend of the graphic above are instantiated with the types in the following table.

<i>Name/Instantiating Type</i>	<i>Parameter</i>	<i>Details</i>
thin_heap		
priority_queue	Tag	thin_heap_tag
pairing_heap		
priority_queue	Tag	pairing_heap_tag

22.4.2.4.7.3 Observations

As noted above, increasing an arbitrary value (in the sense of the priority queue's comparison functor) is very common in graph-related algorithms. In this case, a thin heap (priority_queue with Tag = thin_heap_tag) outperforms a pairing heap (priority_queue with Tag = pairing_heap_tag). Conversely, Priority Queue Text push Timing Test, Priority Queue Text push and pop Timing Test, Priority Queue Random Integer push Timing Test, and Priority Queue Random Integer push and pop Timing Test show that the situation is reversed for other operations. It is not clear when to prefer one of these two different types.

In this test this library's binary heaps effectively perform modify in linear time. As explained in `Priority Queue Design::Traits`, given a valid point-type iterator, a binary heap can perform `modify` logarithmically. The problem is that binary heaps invalidate their `find` iterators with each modifying operation, and so the only way to obtain a valid point-type iterator is to iterate using a range-type iterator until finding the appropriate value, then use the range-type iterator for the `modify` operation.

The explanation for the standard's priority queues' performance is similar to that in `Priority Queue Text join Timing Test`.

22.4.2.4.8 Text `modify` Down

22.4.2.4.8.1 Description

This test inserts a number of values with keys from an arbitrary text ([`wickland96thirty`]) into into a container then modifies each one "down" (i.e., it makes it smaller). It uses `modify` for this library's priority queues; for the standard's priority queues, it pops values from a container until it reaches the value that should be modified, then pushes values back in. It measures the average time for `modify` as a function of the number of values.

It uses the test file: `performance/ext/pb_ds/priority_queue_text_modify_down_timing.cc`

The main purpose of this test is to contrast `Priority Queue Text modify Up Timing Test`.

22.4.2.4.8.2 Results

The two graphics below show the results for the native `priority_queues` and this library's `priority_queues`.

The graphic immediately below shows the results for the native `priority_queue` type instantiated with different underlying container types versus several different versions of library's `priority_queues`.

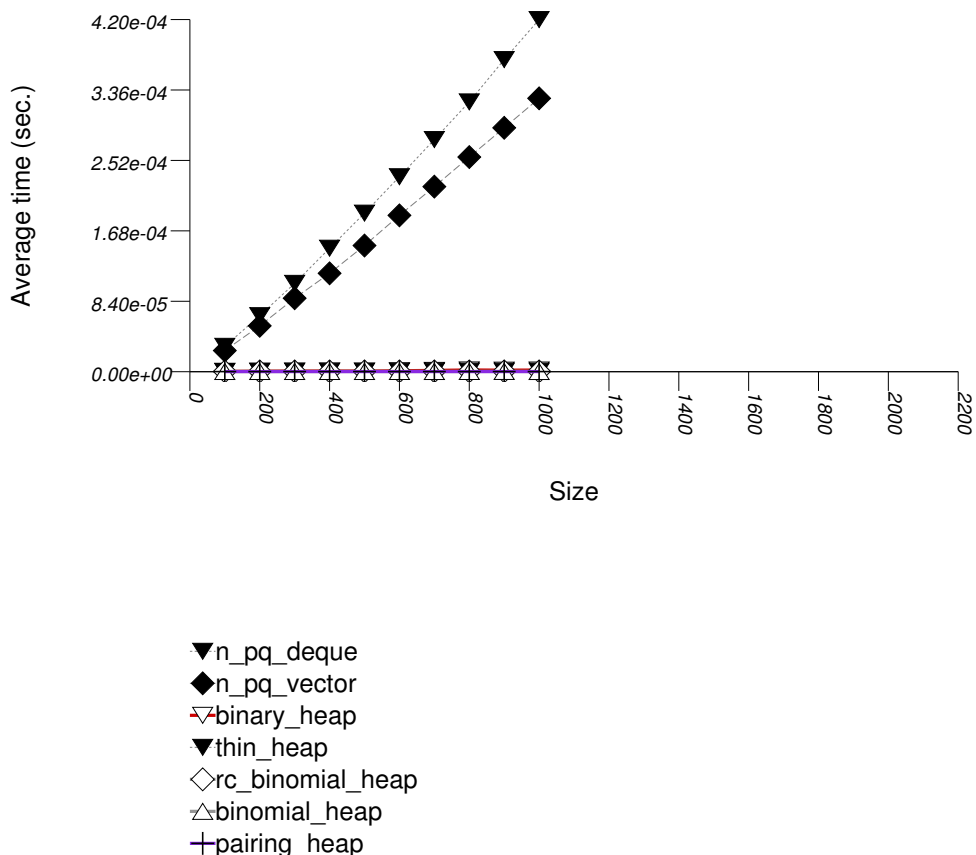

The abbreviated names in the legend of the graphic above are instantiated with the types in the following table.

<i>Name/Instantiating Type</i>	<i>Parameter</i>	<i>Details</i>
n_pq_vector		
std::priority_queue	Sequence	std::vector
n_pq_deque		
std::priority_queue	Sequence	std::deque
binary_heap		
priority_queue	Tag	binary_heap_tag
binomial_heap		
priority_queue	Tag	binomial_heap_tag
rc_binomial_heap		
priority_queue	Tag	rc_binomial_heap_tag
thin_heap		
priority_queue	Tag	thin_heap_tag
pairing_heap		
priority_queue	Tag	pairing_heap_tag

The graphic below shows the results for the native priority queues and this library's pairing and thin heap priority_queue data structures.

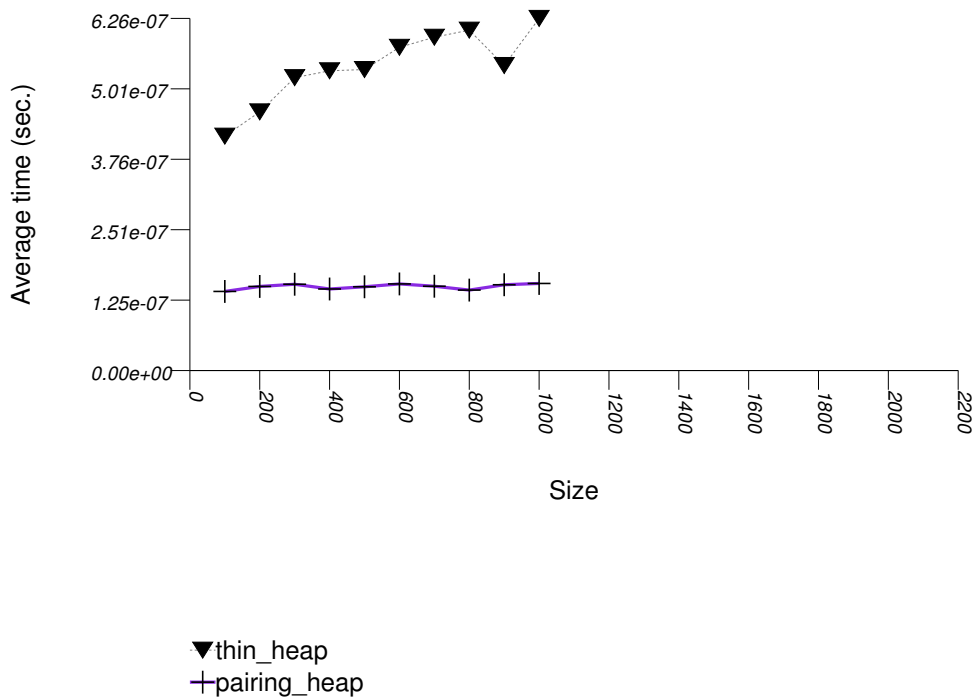

The abbreviated names in the legend of the graphic above are instantiated with the types in the following table.

<i>Name/Instantiating Type</i>	<i>Parameter</i>	<i>Details</i>
thin_heap		
priority_queue	Tag	thin_heap_tag
pairing_heap		
priority_queue	Tag	pairing_heap_tag

22.4.2.4.8.3 Observations

Most points in these results are similar to Priority Queue Text modify Up Timing Test.

It is interesting to note, however, that as opposed to that test, a thin heap (priority_queue with Tag = thin_heap_tag) is

outperformed by a pairing heap (`priority_queue` with `Tag = pairing_heap_tag`). In this case, both heaps essentially perform an `erase` operation followed by a `push` operation. As the other tests show, a pairing heap is usually far more efficient than a thin heap, so this is not surprising.

Most algorithms that involve priority queues increase values (in the sense of the priority queue's comparison functor), and so Priority Queue Text `modify` Up Timing Test - is more interesting than this test.

22.4.2.5 Observations

22.4.2.5.1 Associative

22.4.2.5.1.1 Underlying Data-Structure Families

In general, hash-based containers have better timing performance than containers based on different underlying-data structures. The main reason to choose a tree-based or trie-based container is if a byproduct of the tree-like structure is required: either order-preservation, or the ability to utilize node invariants. If memory-use is the major factor, an ordered-vector tree gives optimal results (albeit with high modification costs), and a list-based container gives reasonable results.

22.4.2.5.1.2 Hash-Based Containers

Hash-based containers are typically either collision chaining or probing. Collision-chaining containers are more flexible internally, and so offer better timing performance. Probing containers, if used for simple value-types, manage memory more efficiently (they perform far fewer allocation-related calls). In general, therefore, a collision-chaining table should be used. A probing container, conversely, might be used efficiently for operations such as eliminating duplicates in a sequence, or counting the number of occurrences within a sequence. Probing containers might be more useful also in multithreaded applications where each thread manipulates a hash-based container: in the standard, allocators have class-wise semantics (see [meyers96more] - Item 10); a probing container might incur less contention in this case.

22.4.2.5.1.3 Hash Policies

In hash-based containers, the range-hashing scheme seems to affect performance more than other considerations. In most settings, a mask-based scheme works well (or can be made to work well). If the key-distribution can be estimated a-priori, a simple hash function can produce nearly uniform hash-value distribution. In many other cases (e.g., text hashing, floating-point hashing), the hash function is powerful enough to generate hash values with good uniformity properties [knuth98sorting]; a modulo-based scheme, taking into account all bits of the hash value, appears to overlap the hash function in its effort.

The range-hashing scheme determines many of the other policies. A mask-based scheme works well with an exponential-size policy; for probing-based containers, it goes well with a linear-probe function.

An orthogonal consideration is the trigger policy. This presents difficult tradeoffs. E.g., different load factors in a load-check trigger policy yield a space/amortized-cost tradeoff.

22.4.2.5.1.4 Branch-Based Containers

In general, there are several families of tree-based underlying data structures: balanced node-based trees (e.g., red-black or AVL trees), high-probability balanced node-based trees (e.g., random treaps or skip-lists), competitive node-based trees (e.g., splay trees), vector-based "trees", and tries. (Additionally, there are disk-residing or network-residing trees, such as B-Trees and their numerous variants. An interface for this would have to deal with the execution model and ACID guarantees; this is out of the scope of this library.) Following are some observations on their application to different settings.

Of the balanced node-based trees, this library includes a red-black tree, as does standard (in practice). This type of tree is the "workhorse" of tree-based containers: it offers both reasonable modification and reasonable lookup time. Unfortunately, this data structure stores a huge amount of metadata. Each node must contain, besides a value, three pointers and a boolean. This type might be avoided if space is at a premium [austern00noset].

High-probability balanced node-based trees suffer the drawbacks of deterministic balanced trees. Although they are fascinating data structures, preliminary tests with them showed their performance was worse than red-black trees. The library does not contain any such trees, therefore.

Competitive node-based trees have two drawbacks. They are usually somewhat unbalanced, and they perform a large number of comparisons. Balanced trees perform one comparison per each node they encounter on a search path; a splay tree performs two comparisons. If the keys are complex objects, e.g., `std::string`, this can increase the running time. Conversely, such trees do well when there is much locality of reference. It is difficult to determine in which case to prefer such trees over balanced trees. This library includes a splay tree.

Ordered-vector trees use very little space [austern00noset]. They do not have any other advantages (at least in this implementation).

Large-fan-out PATRICIA tries have excellent lookup performance, but they do so through maintaining, for each node, a miniature "hash-table". Their space efficiency is low, and their modification performance is bad. These tries might be used for semi-static settings, where order preservation is important. Alternatively, red-black trees cross-referenced with hash tables can be used. [okasaki98mereable] discusses small-fan-out PATRICIA tries for integers, but the cited results seem to indicate that the amortized cost of maintaining such trees is higher than that of balanced trees. Moderate-fan-out trees might be useful for sequences where each element has a limited number of choices, e.g., DNA strings.

22.4.2.5.1.5 Mapping-Semantics

Different mapping semantics were discussed in the introduction and design sections. Here the focus will be on the case where a keys can be composed into primary keys and secondary keys. (In the case where some keys are completely identical, it is trivial that one should use an associative container mapping values to size types.) In this case there are (at least) five possibilities:

1. Use an associative container that allows equivalent-key values (such as `std::multimap`)
2. Use a unique-key value associative container that maps each primary key to some complex associative container of secondary keys, say a tree-based or hash-based container.
3. Use a unique-key value associative container that maps each primary key to some simple associative container of secondary keys, say a list-based container.
4. Use a unique-key value associative container that maps each primary key to some non-associative container (e.g., `std::vector`)
5. Use a unique-key value associative container that takes into account both primary and secondary keys.

Stated simply: there is a simple answer for this. (Excluding option 1, which should be avoided in all cases).

If the expected ratio of secondary keys to primary keys is small, then 3 and 4 seem reasonable. Both types of secondary containers are relatively lightweight (in terms of memory use and construction time), and so creating an entire container object for each primary key is not too expensive. Option 4 might be preferable to option 3 if changing the secondary key of some primary key is frequent - one cannot modify an associative container's key, and the only possibility, therefore, is erasing the secondary key and inserting another one instead; a non-associative container, conversely, can support in-place modification. The actual cost of erasing a secondary key and inserting another one depends also on the allocator used for secondary associative-containers (The tests above used the standard allocator, but in practice one might choose to use, e.g., [boost_pool]). Option 2 is definitely an overkill in this case. Option 1 loses out either immediately (when there is one secondary key per primary key) or almost immediately after that. Option 5 has the same drawbacks as option 2, but it has the additional drawback that finding all values whose primary key is equivalent to some key, might be linear in the total number of values stored (for example, if using a hash-based container).

If the expected ratio of secondary keys to primary keys is large, then the answer is more complicated. It depends on the distribution of secondary keys to primary keys, the distribution of accesses according to primary keys, and the types of operations most frequent.

To be more precise, assume there are m primary keys, primary key i is mapped to n_i secondary keys, and each primary key is mapped, on average, to n secondary keys (i.e., $E(n_i) = n$).

Suppose one wants to find a specific pair of primary and secondary keys. Using 1 with a tree based container (`std::multimap`), the expected cost is $E(\Theta(\log(m) + n_i)) = \Theta(\log(m) + n)$; using 1 with a hash-based container (`std::tr1::unordered_multimap`), the expected cost is $\Theta(n)$. Using 2 with a primary hash-based container and secondary hash-based containers, the expected cost is $O(1)$; using 2 with a primary tree-based container and secondary tree-based containers, the expected cost is (using the Jensen inequality [motwani95random]) $E(O(\log(m) + \log(n_i))) = O(\log(m)) + E(O(\log(n_i))) = O(\log(m)) + O(\log(n))$,

assuming that primary keys are accessed equiprobably. 3 and 4 are similar to 1, but with lower constants. Using 5 with a hash-based container, the expected cost is $O(1)$; using 5 with a tree based container, the cost is $E(\Theta(\log(mn))) = \Theta(\log(m) + \log(n))$.

Suppose one needs the values whose primary key matches some given key. Using 1 with a hash-based container, the expected cost is $\Theta(n)$, but the values will not be ordered by secondary keys (which may or may not be required); using 1 with a tree-based container, the expected cost is $\Theta(\log(m) + n)$, but with high constants; again the values will not be ordered by secondary keys. 2, 3, and 4 are similar to 1, but typically with lower constants (and, additionally, if one uses a tree-based container for secondary keys, they will be ordered). Using 5 with a hash-based container, the cost is $\Theta(mn)$.

Suppose one wants to assign to a primary key all secondary keys assigned to a different primary key. Using 1 with a hash-based container, the expected cost is $\Theta(n)$, but with very high constants; using 1 with a tree-based container, the cost is $\Theta(n \log(mn))$. Using 2, 3, and 4, the expected cost is $\Theta(n)$, but typically with far lower costs than 1. 5 is similar to 1.

22.4.2.5.2 Priority_Queue

22.4.2.5.2.1 Complexity

The following table shows the complexities of the different underlying data structures in terms of orders of growth. It is interesting to note that this table implies something about the constants of the operations as well (see Amortized `push` and `pop` operations).

	<i>push</i>	<i>pop</i>	<i>modify</i>	<i>erase</i>	<i>join</i>
<code>std::priority_queue</code>	$\Theta(n)$ worst $\Theta(\log(n))$ amortized	$\Theta(\log(n))$ Worst	$\Theta(n \log(n))$ Worst [std note 1]	$\Theta(n \log(n))$ [std note 2]	$\Theta(n \log(n))$ [std note 1]
<code>priority_queue<Tag = pairing_heap_tag></code>	$O(1)$	$\Theta(n)$ worst $\Theta(\log(n))$ amortized	$\Theta(n)$ worst $\Theta(\log(n))$ amortized	$\Theta(n)$ worst $\Theta(\log(n))$ amortized	$O(1)$
<code>priority_queue<Tag = binary_heap_tag></code>	$\Theta(n)$ worst $\Theta(\log(n))$ amortized	$\Theta(n)$ worst $\Theta(\log(n))$ amortized	$\Theta(n)$	$\Theta(n)$	$\Theta(n)$
<code>priority_queue<Tag = binomial_heap_tag></code>	$\Theta(\log(n))$ worst $O(1)$ amortized	$\Theta(\log(n))$	$\Theta(\log(n))$	$\Theta(\log(n))$	$\Theta(\log(n))$
<code>priority_queue<Tag = rc_binomial_heap_tag></code>	$O(1)$	$\Theta(\log(n))$	$\Theta(\log(n))$	$\Theta(\log(n))$	$\Theta(\log(n))$
<code>priority_queue<Tag = thin_heap_tag></code>	$O(1)$	$\Theta(n)$ worst $\Theta(\log(n))$ amortized	$\Theta(\log(n))$ worst $O(1)$ amortized, or $\Theta(\log(n))$ amortized [thin_heap_note]	$\Theta(n)$ worst $\Theta(\log(n))$ amortized	$\Theta(n)$

[std note 1] This is not a property of the algorithm, but rather due to the fact that the standard's priority queue implementation does not support iterators (and consequently the ability to access a specific value inside it). If the priority queue is adapting an `std::vector`, then it is still possible to reduce this to $\Theta(n)$ by adapting over the standard's adapter and using the fact that `top` returns a reference to the first value; if, however, it is adapting an `std::deque`, then this is impossible.

[std note 2] As with [std note 1], this is not a property of the algorithm, but rather the standard's implementation. Again, if the priority queue is adapting an `std::vector` then it is possible to reduce this to $\Theta(n)$, but with a very high constant (one must call `std::make_heap` which is an expensive linear operation); if the priority queue is adapting an `std::deque`, then this is impossible.

[thin_heap_note] A thin heap has $\Theta(\log(n))$ worst case `modify` time always, but the amortized time depends on the nature of

the operation: I) if the operation increases the key (in the sense of the priority queue's comparison functor), then the amortized time is $O(1)$, but if II) it decreases it, then the amortized time is the same as the worst case time. Note that for most algorithms, I) is important and II) is not.

22.4.2.5.2.2 Amortized push and pop operations

In many cases, a priority queue is needed primarily for sequences of `push` and `pop` operations. All of the underlying data structures have the same amortized logarithmic complexity, but they differ in terms of constants.

The table above shows that the different data structures are "constrained" in some respects. In general, if a data structure has lower worst-case complexity than another, then it will perform slower in the amortized sense. Thus, for example a redundant-counter binomial heap (`priority_queue` with `Tag = rc_binomial_heap_tag`) has lower worst-case `push` performance than a binomial heap (`priority_queue` with `Tag = binomial_heap_tag`), and so its amortized `push` performance is slower in terms of constants.

As the table shows, the "least constrained" underlying data structures are binary heaps and pairing heaps. Consequently, it is not surprising that they perform best in terms of amortized constants.

1. Pairing heaps seem to perform best for non-primitive types (e.g., `std::strings`), as shown by `Priority Queue Text push Timing Test` and `Priority Queue Text push and pop Timing Test`
2. binary heaps seem to perform best for primitive types (e.g., `ints`), as shown by `Priority Queue Random Integer push Timing Test` and `Priority Queue Random Integer push and pop Timing Test`.

22.4.2.5.2.3 Graph Algorithms

In some graph algorithms, a decrease-key operation is required [clsr2001]; this operation is identical to `modify` if a value is increased (in the sense of the priority queue's comparison functor). The table above and `Priority Queue Text modify Up Timing Test` show that a thin heap (`priority_queue` with `Tag = thin_heap_tag`) outperforms a pairing heap (`priority_queue` with `Tag = Tag = pairing_heap_tag`), but the rest of the tests show otherwise.

This makes it difficult to decide which implementation to use in this case. Dijkstra's shortest-path algorithm, for example, requires $\Theta(n)$ `push` and `pop` operations (in the number of vertices), but $O(n^2)$ `modify` operations, which can be in practice $\Theta(n)$ as well. It is difficult to find an a-priori characterization of graphs in which the actual number of `modify` operations will dwarf the number of `push` and `pop` operations.

22.5 Acknowledgments

Written by Ami Tavory and Vladimir Dreizin (IBM Haifa Research Laboratories), and Benjamin Kosnik (Red Hat).

This library was partially written at IBM's Haifa Research Labs. It is based heavily on policy-based design and uses many useful techniques from *Modern C++ Design: Generic Programming and Design Patterns Applied* by Andrei Alexandrescu.

Two ideas are borrowed from the SGI-STL implementation:

1. The prime-based resize policies use a list of primes taken from the SGI-STL implementation.
2. The red-black trees contain both a root node and a header node (containing metadata), connected in a way that forward and reverse iteration can be performed efficiently.

Some test utilities borrow ideas from `boost::timer`.

We would like to thank Scott Meyers for useful comments (without attributing to him any flaws in the design or implementation of the library).

We would like to thank Matt Austern for the suggestion to include tries.

22.6 Bibliography

- [55] Dave Abrahams , *STL Exception Handling Contract* , 1997, ISO SC22/WG21 .
 - [56] Andrei Alexandrescu , *Modern C++ Design: Generic Programming and Design Patterns Applied* , 2001 , Addison-Wesley Publishing Company .
 - [57] K. Andrew and D. Gleich , *MTF, Bit, and COMB: A Guide to Deterministic and Randomized Algorithms for the List Update Problem*
 - [58] Matthew Austern , *Why You Shouldn't Use set - and What You Should Use Instead* , April, 2000 , C++ Report .
 - [59] Matthew Austern , *A Proposal to Add Hashtables to the Standard Library* , 2001 , ISO SC22/WG21 .
 - [60] Matthew Austern , *Segmented iterators and hierarchical algorithms* , April, 1998 , Generic Programming .
 - [61] Beeman Dawes , *Boost Timer Library* , Boost .
 - [62] Stephen Cleary , *Boost Pool Library* , Boost .
 - [63] Maddock John and Stephen Cleary , *Boost Type Traits Library* , Boost .
 - [64] Gerth Stolting Brodal , *Worst-case efficient priority queues*
 - [65] D. Bulka and D. Mayhew , *Efficient C++ Programming Techniques* , 1997 , Addison-Wesley Publishing Company .
 - [66] T. H. Cormen , C. E. Leiserson , R. L. Rivest , and C. Stein , *Introduction to Algorithms, 2nd edition* , 2001 , MIT Press .
 - [67] D. Dubashi and D. Ranjan , *Balls and bins: A study in negative dependence* , 1998 , Random Structures and Algorithms 13 .
 - [68] R. Fagin , J. Nievergelt , N. Pippenger , and H. R. Strong , *Extendible hashing - a fast access method for dynamic files* , 1979 , ACM Trans. Database Syst. 4 .
 - [69] Jean-Christophe Filliatre , *Ptset: Sets of integers implemented as Patricia trees* , 2000 .
 - [70] M. L. Fredman , R. Sedgwick , D. D. Sleator , and R. E. Tarjan , *The pairing heap: a new form of self-adjusting heap* , 1986 .
 - [71] E. Gamma , R. Helm , R. Johnson , and J. Vlissides , *Design Patterns - Elements of Reusable Object-Oriented Software* , 1995 , Addison-Wesley Publishing Company .
 - [72] A. K. Garg and C. C. Gotlieb , *Order-preserving key transformations* , 1986 , Trans. Database Syst. 11 .
 - [73] J. Hyslop and Herb Sutter , *Making a real hash of things* , May 2002 , C++ Report .
 - [74] N. M. Jossutis , *The C++ Standard Library - A Tutorial and Reference* , 2001 , Addison-Wesley Publishing Company .
 - [75] Haim Kaplan and Robert E. Tarjan , *New Heap Data Structures* , 1999 .
 - [76] Angelika Langer and Klaus Kleft , *Are Set Iterators Mutable or Immutable?* , October 2000 , C/C++ Users Journal .
 - [77] D. E. Knuth , *The Art of Computer Programming - Sorting and Searching* , 1998 , Addison-Wesley Publishing Company .
 - [78] B. Liskov , *Data abstraction and hierarchy* , May 1998 , SIGPLAN Notices 23 .
 - [79] W. Litwin , *Linear hashing: A new tool for file and table addressing* , June 1980 , Proceedings of International Conference on Very Large Data Bases .
 - [80] Maverik Woo , *Deamortization - Part 2: Binomial Heaps* , 2005 .
-

-
- [81] Scott Meyers , *More Effective C++: 35 New Ways to Improve Your Programs and Designs* , 1996 , Addison-Wesley Publishing Company .
 - [82] Scott Meyers , *How Non-Member Functions Improve Encapsulation* , 2000 , C/C++ Users Journal .
 - [83] Scott Meyers , *Effective STL: 50 Specific Ways to Improve Your Use of the Standard Template Library* , 2001 , Addison-Wesley Publishing Company .
 - [84] Scott Meyers , *Class Template, Member Template - or Both?* , 2003 , C/C++ Users Journal .
 - [85] R. Motwani and P. Raghavan , *Randomized Algorithms* , 2003 , Cambridge University Press .
 - [86] *COM: Component Model Object Technologies* , Microsoft .
 - [87] David R. Musser , *Rationale for Adding Hash Tables to the C++ Standard Template Library* , 1995 .
 - [88] David R. Musser and A. Saini , *STL Tutorial and Reference Guide* , 1996 , Addison-Wesley Publishing Company .
 - [89] Mark Nelson , *Priority Queues and the STL* , January 1996 , Dr. Dobbs Journal .
 - [90] C. Okasaki and A. Gill , *Fast mergeable integer maps* , September 1998 , In Workshop on ML .
 - [91] Matt Austern , *Standard Template Library Programmer's Guide* , SGI .
 - [92] *select*
 - [93] D. D. Sleator and R. E. Tarjan , *Amortized Efficiency of List Update Problems* , 1984 , ACM Symposium on Theory of Computing .
 - [94] D. D. Sleator and R. E. Tarjan , *Self-Adjusting Binary Search Trees* , 1985 , ACM Symposium on Theory of Computing .
 - [95] A. A. Stepanov and M. Lee , *The Standard Template Library* , 1984 .
 - [96] Bjarne Stroustrup , *The C++ Programming Language* , 1997 , Addison-Wesley Publishing Company .
 - [97] D. Vandevorode and N. M. Josuttis , *C++ Templates: The Complete Guide* , 2002 , Addison-Wesley Publishing Company .
 - [98] C. A. Wickland , *Thirty Years Among the Dead* , 1996 , National Psychological Institute .
-

Chapter 23

HP/SGI Extensions

23.1 Backwards Compatibility

A few extensions and nods to backwards-compatibility have been made with containers. Those dealing with older SGI-style allocators are dealt with elsewhere. The remaining ones all deal with bits:

The old pre-standard `bit_vector` class is present for backwards compatibility. It is simply a typedef for the `vector<bool>` specialization.

The `bitset` class has a number of extensions, described in the rest of this item. First, we'll mention that this implementation of `bitset<N>` is specialized for cases where N number of bits will fit into a single word of storage. If your choice of N is within that range (≤ 32 on i686-pc-linux-gnu, for example), then all of the operations will be faster.

There are versions of single-bit test, set, reset, and flip member functions which do no range-checking. If we call them member functions of an instantiation of `bitset<N>`, then their names and signatures are:

```
bitset<N>&    _Unchecked_set    (size_t pos);
bitset<N>&    _Unchecked_set    (size_t pos, int val);
bitset<N>&    _Unchecked_reset  (size_t pos);
bitset<N>&    _Unchecked_flip   (size_t pos);
bool         _Unchecked_test   (size_t pos);
```

Note that these may in fact be removed in the future, although we have no present plans to do so (and there doesn't seem to be any immediate reason to).

The member function `operator[]` on a `const` `bitset` returns a `bool`, and for a non-`const` `bitset` returns a reference (a nested type). No range-checking is done on the index argument, in keeping with other containers' `operator[]` requirements.

Finally, two additional searching functions have been added. They return the index of the first "on" bit, and the index of the first "on" bit that is after `prev`, respectively:

```
size_t _Find_first() const;
size_t _Find_next (size_t prev) const;
```

The same caveat given for the `_Unchecked_*` functions applies here also.

23.2 Deprecated

The SGI hashing classes `hash_set` and `hash_multiset` have been deprecated by the `unordered_set`, `unordered_multiset`, `unordered_map`, `unordered_multimap` containers in TR1 and C++11, and may be removed in future releases.

The SGI headers

```
<hash_map>
<hash_set>
<rope>
<slit>
<rb_tree>
```

are all here; `<backwards/hash_map>` and `<backwards/hash_set>` are deprecated but available as backwards-compatible extensions, as discussed further below. `<ext/rope>` is the SGI specialization for large strings ("rope," "large strings," get it? Love that geeky humor.) `<ext/slist>` (superseded in C++11 by `<forward_list>`) is a singly-linked list, for when the doubly-linked `list<>` is too much space overhead, and `<ext/rb_tree>` exposes the red-black tree classes used in the implementation of the standard maps and sets.

Each of the associative containers `map`, `multimap`, `set`, and `multiset` have a counterpart which uses a **hashing function** to do the arranging, instead of a strict weak ordering function. The classes take as one of their template parameters a function object that will return the hash value; by default, an instantiation of `hash`. You should specialize this functor for your class, or define your own, before trying to use one of the hashing classes.

The hashing classes support all the usual associative container functions, as well as some extra constructors specifying the number of buckets, etc.

Why would you want to use a hashing class instead of the “normal” implementations? Matt Austern writes:

[W]ith a well chosen hash function, hash tables generally provide much better average-case performance than binary search trees, and much worse worst-case performance. So if your implementation has `hash_map`, if you don't mind using nonstandard components, and if you aren't scared about the possibility of pathological cases, you'll probably get better performance from `hash_map`.

The deprecated hash tables are superseded by the standard unordered associative containers defined in the ISO C++ 2011 standard in the headers `<unordered_map>` and `<unordered_set>`.

Chapter 24

Utilities

The `<functional>` header contains many additional functors and helper functions, extending section 20.3. They are implemented in the file `stl_function.h`:

- `identity_element` for addition and multiplication.
- The functor `identity`, whose `operator()` returns the argument unchanged.
- Composition functors `unary_function` and `binary_function`, and their helpers `compose1` and `compose2`.
- `select1st` and `select2nd`, to strip pairs.
- `project1st` and `project2nd`.
- A set of functors/functions which always return the same result. They are `constant_void_fun`, `constant_binary_fun`, `constant_unary_fun`, `constant0`, `constant1`, and `constant2`.
- The class `subtractive_rng`.
- `mem_fun` adaptor helpers `mem_fun1` and `mem_fun1_ref` are provided for backwards compatibility.

20.4.1 can use several different allocators; they are described on the main extensions page.

20.4.3 is extended with a special version of `get_temporary_buffer` taking a second argument. The argument is a pointer, which is ignored, but can be used to specify the template type (instead of using explicit function template arguments like the standard version does). That is, in addition to

```
get_temporary_buffer<int>(5);
```

you can also use

```
get_temporary_buffer(5, (int*)0);
```

A class `temporary_buffer` is given in `stl_tempbuf.h`.

The specialized algorithms of section 20.4.4 are extended with `uninitialized_copy_n`.

Chapter 25

Algorithms

25.1.6 (`count`, `count_if`) is extended with two more versions of `count` and `count_if`. The standard versions return their results. The additional signatures return `void`, but take a final parameter by reference to which they assign their results, e.g.,

```
void count (first, last, value, n);
```

25.2 (mutating algorithms) is extended with two families of signatures, `random_sample` and `random_sample_n`.

25.2.1 (`copy`) is extended with

```
copy_n (_InputIter first, _Size count, _OutputIter result);
```

which copies the first 'count' elements at 'first' into 'result'.

25.3 (sorting 'n' heaps 'n' stuff) is extended with some helper predicates. Look in the doxygen-generated pages for notes on these.

- `is_heap` tests whether or not a range is a heap.
- `is_sorted` tests whether or not a range is sorted in nondescending order.

25.3.8 (`lexicographical_compare`) is extended with

```
lexicographical_compare_3way(_InputIter1 first1, _InputIter1 last1,  
                             _InputIter2 first2, _InputIter2 last2)
```

which does... what?

Chapter 26

Numerics

26.4, the generalized numeric operations such as `accumulate`, are extended with the following functions:

```
power (x, n);  
power (x, n, monoid_operation);
```

Returns, in FORTRAN syntax, "`x ** n`" where `n >= 0`. In the case of `n == 0`, returns the identity element for the monoid operation. The two-argument signature uses multiplication (for a true "power" implementation), but addition is supported as well. The operation functor must be associative.

The `iota` function wins the award for Extension With the Coolest Name (the name comes from Ken Iverson's APL language.) As described in the [SGI documentation](#), it "assigns sequentially increasing values to a range. That is, it assigns value to `*first, value + 1` to `*(first + 1)` and so on."

```
void iota(_ForwardIter first, _ForwardIter last, _Tp value);
```

The `iota` function is included in the ISO C++ 2011 standard.

Chapter 27

Iterators

24.3.2 describes `struct iterator`, which didn't exist in the original HP STL implementation (the language wasn't rich enough at the time). For backwards compatibility, base classes are provided which declare the same nested typedefs:

- `input_iterator`
- `output_iterator`
- `forward_iterator`
- `bidirectional_iterator`
- `random_access_iterator`

24.3.4 describes iterator operation `distance`, which takes two iterators and returns a result. It is extended by another signature which takes two iterators and a reference to a result. The result is modified, and the function returns nothing.

Chapter 28

Input and Output

Extensions allowing `filebufs` to be constructed from "C" types like `FILE*`s and file descriptors.

28.1 Derived filebufs

The v2 library included non-standard extensions to construct `std::filebufs` from C stdio types such as `FILE*`s and POSIX file descriptors. Today the recommended way to use stdio types with libstdc++ IOStreams is via the `stdio_filebuf` class (see below), but earlier releases provided slightly different mechanisms.

- 3.0.x `filebufs` have another ctor with this signature: `basic_filebuf(__c_file_type*, ios_base::openmode, int_type)`; This comes in very handy in a number of places, such as attaching Unix sockets, pipes, and anything else which uses file descriptors, into the IOStream buffering classes. The three arguments are as follows:

- `__c_file_type* F` // the `__c_file_type` typedef usually boils down to stdio's `FILE`
- `ios_base::openmode M` // same as all the other uses of `openmode`
- `int_type B` // buffer size, defaults to `BUFSIZ` if not specified

For those wanting to use file descriptors instead of `FILE*`'s, I invite you to contemplate the mysteries of C's `fdopen()`.

- In library snapshot 3.0.95 and later, `filebufs` bring back an old extension: the `fd()` member function. The integer returned from this function can be used for whatever file descriptors can be used for on your platform. Naturally, the library cannot track what you do on your own with a file descriptor, so if you perform any I/O directly, don't expect the library to be aware of it.
- Beginning with 3.1, the extra `filebuf` constructor and the `fd()` function were removed from the standard `filebuf`. Instead, `<ext/stdio_filebuf.h>` contains a derived class called `__gnu_cxx::stdio_filebuf`. This class can be constructed from a C `FILE*` or a file descriptor, and provides the `fd()` function.

Chapter 29

Demangling

Transforming C++ ABI identifiers (like RTTI symbols) into the original C++ source identifiers is called “demangling.”

If you have read the [source documentation for namespace abi](#) then you are aware of the cross-vendor C++ ABI in use by GCC. One of the exposed functions is used for demangling, `abi::__cxa_demangle`.

In programs like `c++filt`, the linker, and other tools have the ability to decode C++ ABI names, and now so can you.

(The function itself might use different demanglers, but that’s the whole point of abstract interfaces. If we change the implementation, you won’t notice.)

Probably the only times you’ll be interested in demangling at runtime are when you’re seeing `typeid` strings in RTTI, or when you’re handling the runtime-support exception classes. For example:

```
#include <exception>
#include <iostream>
#include <cxxabi.h>

struct empty { };

template <typename T, int N>
    struct bar { };

int main()
{
    int    status;
    char  *realname;

    // exception classes not in <stdexcept>, thrown by the implementation
    // instead of the user
    std::bad_exception e;
    realname = abi::__cxa_demangle(e.what(), 0, 0, &status);
    std::cout << e.what() << "\t=> " << realname << "\t: " << status << '\n';
    free(realname);

    // typeid
    bar<empty,17>      u;
    const std::type_info &ti = typeid(u);

    realname = abi::__cxa_demangle(ti.name(), 0, 0, &status);
    std::cout << ti.name() << "\t=> " << realname << "\t: " << status << '\n';
    free(realname);

    return 0;
}
```

This prints

```
St13bad_exception      => std::bad_exception    : 0
3barI5emptyLi17EE     => bar<empty, 17>        : 0
```

The demangler interface is described in the source documentation linked to above. It is actually written in C, so you don't need to be writing C++ in order to demangle C++. (That also means we have to use crummy memory management facilities, so don't forget to free() the returned char array.)

Chapter 30

Concurrency

30.1 Design

30.1.1 Interface to Locks and Mutexes

The file `<ext/concurrency.h>` contains all the higher-level constructs for playing with threads. In contrast to the atomics layer, the concurrence layer consists largely of types. All types are defined within namespace `__gnu_cxx`.

These types can be used in a portable manner, regardless of the specific environment. They are carefully designed to provide optimum efficiency and speed, abstracting out underlying thread calls and accesses when compiling for single-threaded situations (even on hosts that support multiple threads.)

The enumerated type `_Lock_policy` details the set of available locking policies: `_S_single`, `_S_mutex`, and `_S_atomic`.

- `_S_single`
Indicates single-threaded code that does not need locking.
- `_S_mutex`
Indicates multi-threaded code using thread-layer abstractions.
- `_S_atomic`
Indicates multi-threaded code using atomic operations.

The compile-time constant `__default_lock_policy` is set to one of the three values above, depending on characteristics of the host environment and the current compilation flags.

Two more datatypes make up the rest of the interface: `__mutex`, and `__scoped_lock`.

The scoped lock idiom is well-discussed within the C++ community. This version takes a `__mutex` reference, and locks it during construction of `__scoped_lock` and unlocks it during destruction. This is an efficient way of locking critical sections, while retaining exception-safety. These types have been superseded in the ISO C++ 2011 standard by the `mutex` and `lock` types defined in the header `<mutex>`.

30.1.2 Interface to Atomic Functions

Two functions and one type form the base of atomic support.

The type `_Atomic_word` is a signed integral type supporting atomic operations.

The two functions functions are:

```

_Atomic_word
__exchange_and_add_dispatch(volatile _Atomic_word*, int);

void
__atomic_add_dispatch(volatile _Atomic_word*, int);

```

Both of these functions are declared in the header file `<ext/atomicity.h>`, and are in namespace `__gnu_cxx`.

- `__exchange_and_add_dispatch`
Adds the second argument's value to the first argument. Returns the old value.
- `__atomic_add_dispatch`
Adds the second argument's value to the first argument. Has no return value.

These functions forward to one of several specialized helper functions, depending on the circumstances. For instance,

```
__exchange_and_add_dispatch
```

Calls through to either of:

- `__exchange_and_add`
Multi-thread version. Inlined if compiler-generated builtin atomics can be used, otherwise resolved at link time to a non-builtin code sequence.
- `__exchange_and_add_single`
Single threaded version. Inlined.

However, only `__exchange_and_add_dispatch` and `__atomic_add_dispatch` should be used. These functions can be used in a portable manner, regardless of the specific environment. They are carefully designed to provide optimum efficiency and speed, abstracting out atomic accesses when they are not required (even on hosts that support compiler intrinsics for atomic operations.)

In addition, there are two macros

```

_GLIBCXX_READ_MEM_BARRIER
_GLIBCXX_WRITE_MEM_BARRIER

```

Which expand to the appropriate write and read barrier required by the host hardware and operating system.

30.2 Implementation

30.2.1 Using Builtin Atomic Functions

The functions for atomic operations described above are either implemented via compiler intrinsics (if the underlying host is capable) or by library fallbacks.

Compiler intrinsics (builtins) are always preferred. However, as the compiler builtins for atomics are not universally implemented, using them directly is problematic, and can result in undefined function calls. (An example of an undefined symbol from the use of `__sync_fetch_and_add` on an unsupported host is a missing reference to `__sync_fetch_and_add_4`.)

 In addition, on some hosts the compiler intrinsics are enabled conditionally, via the `-march` command line flag. This makes the behavior vary depending on the target hardware and the flags used during compile.

If builtins are possible for bool-sized integral types, `ATOMIC_BOOL_LOCK_FREE` will be defined. If builtins are possible for int-sized integral types, `ATOMIC_INT_LOCK_FREE` will be defined.

For the following hosts, intrinsics are enabled by default.

- alpha
- ia64
- powerpc
- s390

For others, some form of `-march` may work. On non-ancient x86 hardware, `-march=native` usually does the trick.

For hosts without compiler intrinsics, but with capable hardware, hand-crafted assembly is selected. This is the case for the following hosts:

- cris
- hppa
- i386
- i486
- m48k
- mips
- sparc

And for the rest, a simulated atomic lock via `pthread`s.

Detailed information about compiler intrinsics for atomic operations can be found in the [GCC documentation](#).

More details on the library fallbacks from the porting [section](#).

30.2.2 Thread Abstraction

A thin layer above IEEE 1003.1 (i.e. `pthread`s) is used to abstract the thread interface for GCC. This layer is called "gthread," and is comprised of one header file that wraps the host's default thread layer with a POSIX-like interface.

The file `<gthr-default.h>` points to the deduced wrapper for the current host. In `libstdc++` implementation files, `<bits/gthr.h>` is used to select the proper `gthreads` file.

Within `libstdc++` sources, all calls to underlying thread functionality use this layer. More detail as to the specific interface can be found in the source [documentation](#).

By design, the `gthread` layer is interoperable with the types, functions, and usage found in the usual `<pthread.h>` file, including `pthread_t`, `pthread_once_t`, `pthread_create`, etc.

30.3 Use

Typical usage of the last two constructs is demonstrated as follows:

```
#include <ext/concurrency.h>

namespace
{
    __gnu_cxx::__mutex safe_base_mutex;
} // anonymous namespace

namespace other
{
    void
```

```
foo()
{
    __gnu_cxx::__scoped_lock sentry(safe_base_mutex);
    for (int i = 0; i < max; ++i)
    {
        _Safe_iterator_base* __old = __iter;
        __iter = __iter-<_M_next;
        __old-<_M_detach_single();
    }
}
```

In this sample code, an anonymous namespace is used to keep the `__mutex` private to the compilation unit, and `__scoped_lock` is used to guard access to the critical section within the for loop, locking the mutex on creation and freeing the mutex as control moves out of this block.

Several exception classes are used to keep track of concurrence-related errors. These classes are: `__concurrency_lock_error`, `__concurrency_unlock_error`, `__concurrency_wait_error`, and `__concurrency_broadcast_error`.

Part IV

Appendices

Appendix A

Contributing

The GNU C++ Library is part of GCC and follows the same development model, so the general rules for [contributing to GCC](#) apply. Active contributors are assigned maintainership responsibility, and given write access to the source repository. First-time contributors should follow this procedure:

A.1 Contributor Checklist

A.1.1 Reading

- Get and read the relevant sections of the C++ language specification. Copies of the full ISO 14882 standard are available on line via the ISO mirror site for committee members. Non-members, or those who have not paid for the privilege of sitting on the committee and sustained their two meeting commitment for voting rights, may get a copy of the standard from their respective national standards organization. In the USA, this national standards organization is [ANSI](#). (And if you've already registered with them you can [buy the standard on-line](#).)
- The library working group bugs, and known defects, can be obtained here: <http://www.open-std.org/jtc1/sc22/wg21>
- Peruse the [GNU Coding Standards](#), and chuckle when you hit the part about “Using Languages Other Than C”.
- Be familiar with the extensions that preceded these general GNU rules. These style issues for libstdc++ can be found in [Coding Style](#).
- And last but certainly not least, read the library-specific information found in [Porting and Maintenance](#).

A.1.2 Assignment

See the [legal prerequisites](#) for all GCC contributions.

Historically, the libstdc++ assignment form added the following question:

“ Which Belgian comic book character is better, Tintin or Asterix, and why? ”

While not strictly necessary, humoring the maintainers and answering this question would be appreciated.

Please contact Benjamin Kosnik at bkoz+assign@redhat.com if you are confused about the assignment or have general licensing questions. When requesting an assignment form from <mailto:assign@gnu.org>, please cc the libstdc++ maintainer above so that progress can be monitored.

A.1.3 Getting Sources

[Getting write access \(look for "Write after approval"\)](#)

A.1.4 Submitting Patches

Every patch must have several pieces of information before it can be properly evaluated. Ideally (and to ensure the fastest possible response from the maintainers) it would have all of these pieces:

- A description of the bug and how your patch fixes this bug. For new features a description of the feature and your implementation.
- A ChangeLog entry as plain text; see the various ChangeLog files for format and content. If you are using emacs as your editor, simply position the insertion point at the beginning of your change and hit `CX-4a` to bring up the appropriate ChangeLog entry. See--magic! Similar functionality also exists for `vi`.
- A testsuite submission or sample program that will easily and simply show the existing error or test new functionality.
- The patch itself. If you are accessing the SVN repository use **svn update; svn diff NEW**; else, use **diff -cp OLD NEW ...**. If your version of diff does not support these options, then get the latest version of GNU diff. The [SVN Tricks](#) wiki page has information on customising the output of `svn diff`.
- When you have all these pieces, bundle them up in a mail message and send it to `libstdc++@gcc.gnu.org`. All patches and related discussion should be sent to the libstdc++ mailing list.

A.2 Directory Layout and Source Conventions

The unpacked source directory of libstdc++ contains the files needed to create the GNU C++ Library.

It has subdirectories:

`doc`

Files in HTML and text format that document usage, quirks of the implementation, and contributor checklists.

`include`

All header files for the C++ library are within this directory, modulo specific runtime-related files that are in the `libsupc++` directory.

`include/std`

Files meant to be found by `#include <name>` directives in standard-conforming user programs.

`include/c`

Headers intended to directly include standard C headers. [NB: this can be enabled via `--enable-headers=c`]

`include/c_global`

Headers intended to include standard C headers in the global namespace, and put select names into the `std::` namespace. [NB: this is the default, and is the same as `--enable-headers=c_global`]

`include/c_std`

Headers intended to include standard C headers already in namespace `std`, and put select names into the `std::` namespace. [NB: this is the same as `--enable-headers=c_std`]

`include/bits`

Files included by standard headers and by other files in

the bits directory.

include/backward

Headers provided for backward compatibility, such as <iostream.h>. They are not used in this library.

include/ext

Headers that define extensions to the standard library. No standard header refers to any of them.

scripts

Scripts that are used during the configure, build, make, or test process.

src

Files that are used in constructing the library, but are not installed.

testsuites/[backward, demangle, ext, performance, thread, 17_* to 30_*]

Test programs are here, and may be used to begin to exercise the library. Support for "make check" and "make check-install" is complete, and runs through all the subdirectories here when this command is issued from the build directory. Please note that "make check" requires DejaGNU 1.4 or later to be installed. Please note that "make check-script" calls the script mkcheck, which requires bash, and which may need the paths to bash adjusted to work properly, as /bin/bash is assumed.

Other subdirectories contain variant versions of certain files that are meant to be copied or linked by the configure script. Currently these are:

config/abi
config/cpu
config/io
config/locale
config/os

In addition, a subdirectory holds the convenience library libsupc++.

libsupc++

Contains the runtime library for C++, including exception handling and memory allocation and deallocation, RTTI, terminate handlers, etc.

Note that glibc also has a bits/ subdirectory. We will either need to be careful not to collide with names in its bits/ directory; or rename bits to (e.g.) cppbits/.

In files throughout the system, lines marked with an "XXX" indicate a bug or incompletely-implemented feature. Lines marked "XXX MT" indicate a place that may require attention for multi-thread safety.

A.3 Coding Style

A.3.1 Bad Identifiers

Identifiers that conflict and should be avoided.

This is the list of names reserved to the implementation that have been claimed by certain compilers and system headers of interest, and should not be used in the library. It will grow, of course. We generally are interested in names that are not all-caps, except for those like "_T"

For Solaris:

```
_B  
_C  
_L  
_N  
_P  
_S  
_U  
_X  
_E1  
..  
_E24
```

Irix adds:

```
_A  
_G
```

MS adds:

```
_T
```

BSD adds:

```
__used  
__unused  
__inline  
_Complex  
__istype  
__maskrune  
__tolower  
__toupper  
__wchar_t  
__wint_t  
_res  
_res_ext  
__tg_*
```

SPU adds:

```
__ea
```

For GCC:

[Note that this list is out of date. It applies to the old name-mangling; in G++ 3.0 and higher a different name-mangling is used. In addition, many of the bugs relating to G++ interpreting these names as operators have been fixed.]

The full set of `__*` identifiers (combined from `gcc/cp/lex.c` and `gcc/cplus-dem.c`) that are either old or new, but are definitely recognized by the demangler, is:

```
__aa
__aad
__ad
__addr
__adv
__aer
__als
__alshift
__amd
__ami
__aml
__amu
__aor
__apl
__array
__ars
__arshift
__as
__bit_and
__bit_ior
__bit_not
__bit_xor
__call
__cl
__cm
__cn
__co
__component
__compound
__cond
__convert
__delete
__dl
__dv
__eq
__er
__ge
__gt
__indirect
__le
__ls
__lt
__max
__md
__method_call
__mi
__min
__minus
__ml
__mm
__mn
__mult
```

__mx
__ne
__negate
__new
__nop
__nt
__nw
__oo
__op
__or
__pl
__plus
__postdecrement
__postincrement
__pp
__pt
__rf
__rm
__rs
__sz
__trunc_div
__trunc_mod
__truth_andif
__truth_not
__truth_orif
__vc
__vd
__vn

SGI badnames:

__builtin_alloca
__builtin_fsqrt
__builtin_sqrt
__builtin_fabs
__builtin_dabs
__builtin_cast_f2i
__builtin_cast_i2f
__builtin_cast_d2ll
__builtin_cast_ll2d
__builtin_copy_dhi2i
__builtin_copy_i2dhi
__builtin_copy_dlo2i
__builtin_copy_i2dlo
__add_and_fetch
__sub_and_fetch
__or_and_fetch
__xor_and_fetch
__and_and_fetch
__nand_and_fetch
__mpy_and_fetch
__min_and_fetch
__max_and_fetch
__fetch_and_add
__fetch_and_sub
__fetch_and_or
__fetch_and_xor
__fetch_and_and

```

__fetch_and_nand
__fetch_and_mpy
__fetch_and_min
__fetch_and_max
__lock_test_and_set
__lock_release
__lock_acquire
__compare_and_swap
__synchronize
__high_multiply
__unix
__sgi
__linux__
__i386__
__i486__
__cplusplus
__embedded_cplusplus
// long double conversion members mangled as __opr
// http://gcc.gnu.org/ml/libstdc++/1999-q4/msg00060.html
__opr

```

A.3.2 By Example

This library is written to appropriate C++ coding standards. As such, it is intended to precede the recommendations of the GNU Coding Standard, which can be referenced in full here:

<http://www.gnu.org/prep/standards/standards.html#Formatting>

The rest of this is also interesting reading, but skip the "Design Advice" part.

The GCC coding conventions are here, and are also useful:

<http://gcc.gnu.org/codingconventions.html>

In addition, because it doesn't seem to be stated explicitly anywhere else, there is an 80 column source limit.

ChangeLog entries for member functions should use the `classname::member` function name syntax as follows:

```
1999-04-15  Dennis Ritchie  <dr@att.com>
```

```
* src/basic_file.cc (__basic_file::open): Fix thinko in
_G_HAVE_IO_FILE_OPEN bits.
```

Notable areas of divergence from what may be previous local practice (particularly for GNU C) include:

01. Pointers and references

```
char* p = "flop";
char& c = *p;
```

```
-NOT-  
char *p = "flop"; // wrong  
char &c = *p;     // wrong
```

Reason: In C++, definitions are mixed with executable code. Here, `p` is being initialized, not `*p`. This is near-universal practice among C++ programmers; it is normal for C hackers to switch spontaneously as they gain experience.

02. Operator names and parentheses

```
operator==(type)  
-NOT-  
operator == (type) // wrong
```

Reason: The `==` is part of the function name. Separating it makes the declaration look like an expression.

03. Function names and parentheses

```
void mangle()  
-NOT-  
void mangle () // wrong
```

Reason: no space before parentheses (except after a control-flow keyword) is near-universal practice for C++. It identifies the parentheses as the function-call operator or declarator, as opposed to an expression or other overloaded use of parentheses.

04. Template function indentation

```
template<typename T>  
void  
template_function(args)  
{ }  
-NOT-  
template<class T>  
void template_function(args) {};
```

Reason: In class definitions, without indentation whitespace is needed both above and below the declaration to distinguish it visually from other members. (Also, re: "typename" rather than "class".) `T` often could be `int`, which is not a class. ("class", here, is an anachronism.)

05. Template class indentation

```
template<typename _CharT, typename _Traits>  
class basic_ios : public ios_base  
{  
public:  
    // Types:  
};
```

```
-NOT-
template<class _CharT, class _Traits>
class basic_ios : public ios_base
{
public:
    // Types:
};
-NOT-
template<class _CharT, class _Traits>
class basic_ios : public ios_base
{
public:
    // Types:
};
```

06. Enumerators

```
enum
{
    space = _ISspace,
    print = _ISprint,
    cntrl = _IScntrl
};
-NOT-
enum { space = _ISspace, print = _ISprint, cntrl = _IScntrl };
```

07. Member initialization lists

All one line, separate from class name.

```
gribble::gribble()
: _M_private_data(0), _M_more_stuff(0), _M_helper(0)
{ }
-NOT-
gribble::gribble() : _M_private_data(0), _M_more_stuff(0), _M_helper(0)
{ }
```

08. Try/Catch blocks

```
try
{
    //
}
catch (...)
{
    //
}
-NOT-
try {
    //
} catch(...) {
    //
}
```

09. Member functions declarations and definitions

Keywords such as `extern`, `static`, `export`, `explicit`, `inline`, etc go on the line above the function name. Thus

```
virtual int
foo()
- NOT -
virtual int foo()
```

Reason: GNU coding conventions dictate return types for functions are on a separate line than the function name and parameter list for definitions. For C++, where we have member functions that can be either inline definitions or declarations, keeping to this standard allows all member function names for a given class to be aligned to the same margin, increasing readability.

10. Invocation of member functions with "this->"

For non-uglified names, use `this->name` to call the function.

```
this->sync()
- NOT -
sync()
```

Reason: Koenig lookup.

11. Namespaces

```
namespace std
{
    blah blah blah;
} // namespace std
```

- NOT -

```
namespace std {
    blah blah blah;
} // namespace std
```

12. Spacing under protected and private in class declarations:

space above, none below
i.e.

```
public:
    int foo;
```

- NOT -

```
public:

    int foo;
```

13. Spacing WRT return statements.
no extra spacing before returns, no parenthesis
i.e.

```
}  
return __ret;
```

-NOT-
}

```
return __ret;
```

-NOT-

```
}  
return (__ret);
```

14. Location of global variables.
All global variables of class type, whether in the "user visible" space (e.g., `cin`) or the implementation namespace, must be defined as a character array with the appropriate alignment and then later re-initialized to the correct value.

This is due to startup issues on certain platforms, such as AIX. For more explanation and examples, see `src/globals.cc`. All such variables should be contained in that file, for simplicity.

15. Exception abstractions
Use the exception abstractions found in `functexcept.h`, which allow C++ programmers to use this library with `-fno-exceptions`. (Even if that is rarely advisable, it's a necessary evil for backwards compatibility.)

16. Exception error messages
All start with the name of the function where the exception is thrown, and then (optional) descriptive text is added. Example:

```
__throw_logic_error(__N("basic_string::_S_construct NULL not valid"));
```

Reason: The verbose terminate handler prints out `exception::what()`, as well as the `typeinfo` for the thrown exception. As this is the default terminate handler, by putting location info into the exception string, a very useful error message is printed out for uncaught exceptions. So useful, in fact, that non-programmers can give useful error messages, and programmers can intelligently speculate what went wrong without even using a debugger.

17. The doxygen style guide to comments is a separate document, see [index](#).

The library currently has a mixture of GNU-C and modern C++ coding styles. The GNU C usages will be combed out gradually.

Name patterns:

For nonstandard names appearing in Standard headers, we are constrained to use names that begin with underscores. This is called "uglification". The convention is:

Local and argument names: `__[a-z].*`

Examples: `__count` `__ix` `__s1`

Type names and template formal-argument names: `__[A-Z][^_].*`

Examples: `_Helper` `_CharT` `_N`

Member data and function names: `__M_.*`

Examples: `__M_num_elements` `__M_initialize ()`

Static data members, constants, and enumerations: `__S_.*`

Examples: `__S_max_elements` `__S_default_value`

Don't use names in the same scope that differ only in the prefix, e.g. `__S_top` and `__M_top`. See BADNAMES for a list of forbidden names. (The most tempting of these seem to be `__T` and `__sz`.)

Names must never have `__` internally; it would confuse name unmanglers on some targets. Also, never use `__[0-9]`, same reason.

[BY EXAMPLE]

```
#ifndef __HEADER__
#define __HEADER__ 1

namespace std
{
  class gribble
  {
  public:
    gribble() throw();

    gribble(const gribble&);

    explicit
    gribble(int __howmany);

    gribble&
    operator=(const gribble&);

    virtual
    ~gribble() throw ();
```

```
// Start with a capital letter, end with a period.
inline void
public_member(const char* __arg) const;

// In-class function definitions should be restricted to one-liners.
int
one_line() { return 0 }

int
two_lines(const char* arg)
{ return strchr(arg, 'a'); }

inline int
three_lines(); // inline, but defined below.

// Note indentation.
template<typename _Formal_argument>
void
public_template() const throw();

template<typename _Iterator>
void
other_template();

private:
class _Helper;

int _M_private_data;
int _M_more_stuff;
_Helper* _M_helper;
int _M_private_function();

enum _Enum
{
    _S_one,
    _S_two
};

static void
_S_initialize_library();
};

// More-or-less-standard language features described by lack, not presence ←
.
# ifndef _G_NO_LONGLONG
extern long long _G_global_with_a_good_long_name; // avoid globals!
# endif

// Avoid in-class inline definitions, define separately;
// likewise for member class definitions:
inline int
gribble::public_member() const
{ int __local = 0; return __local; }

class gribble::_Helper
{
```

```
    int _M_stuff;

    friend class gribble;
};
}

// Names beginning with "__": only for arguments and
// local variables; never use "__" in a type name, or
// within any name; never use "__[0-9]".

#endif /* _HEADER_ */

namespace std
{
    template<typename T> // notice: "typename", not "class", no space
        long_return_value_type<with_many, args>
        function_name(char* pointer, // "char *pointer" is wrong.
                      char* argument,
                      const Reference& ref)
        {
            // int a_local; /* wrong; see below. */
            if (test)
            {
                nested code
            }

            int a_local = 0; // declare variable at first use.

            // char a, b, *p; /* wrong */
            char a = 'a';
            char b = a + 1;
            char* c = "abc"; // each variable goes on its own line, always.

            // except maybe here...
            for (unsigned i = 0, mask = 1; mask; ++i, mask <<= 1) {
                // ...
            }
        }

    gribble::gribble()
    : _M_private_data(0), _M_more_stuff(0), _M_helper(0)
    { }

    int
    gribble::three_lines()
    {
        // doesn't fit in one line.
    }
} // namespace std
```

A.4 Design Notes

The Library

This paper is covers two major areas:

- Features and policies not mentioned in the standard that the quality of the library implementation depends on, including extensions and "implementation-defined" features;
- Plans for required but unimplemented library features and optimizations to them.

Overhead

The standard defines a large library, much larger than the standard C library. A naive implementation would suffer substantial overhead in compile time, executable size, and speed, rendering it unusable in many (particularly embedded) applications. The alternative demands care in construction, and some compiler support, but there is no need for library subsets.

What are the sources of this overhead? There are four main causes:

- The library is specified almost entirely as templates, which with current compilers must be included in-line, resulting in very slow builds as tens or hundreds of thousands of lines of function definitions are read for each user source file. Indeed, the entire SGI STL, as well as the dos Reis valarray, are provided purely as header files, largely for simplicity in porting. Iostream/locale is (or will be) as large again.
 - The library is very flexible, specifying a multitude of hooks where users can insert their own code in place of defaults. When these hooks are not used, any time and code expended to support that flexibility is wasted.
 - Templates are often described as causing to "code bloat". In practice, this refers (when it refers to anything real) to several independent processes. First, when a class template is manually instantiated in its entirety, current compilers place the definitions for all members in a single object file, so that a program linking to one member gets definitions of all. Second, template functions which do not actually depend on the template argument are, under current compilers, generated anew for each instantiation, rather than being shared with other instantiations. Third, some of the flexibility mentioned above comes from virtual functions (both in regular classes and template classes) which current linkers add to the executable file even when they manifestly cannot be called.
 - The library is specified to use a language feature, exceptions, which in the current gcc compiler ABI imposes a run time and code space cost to handle the possibility of exceptions even when they are not used. Under the new ABI (accessed with `-fnew-abi`), there is a space overhead and a small reduction in code efficiency resulting from lost optimization opportunities associated with
-

non-local branches associated with exceptions.

What can be done to eliminate this overhead? A variety of coding techniques, and compiler, linker and library improvements and extensions may be used, as covered below. Most are not difficult, and some are already implemented in varying degrees.

Overhead: Compilation Time

Providing "ready-instantiated" template code in object code archives allows us to avoid generating and optimizing template instantiations in each compilation unit which uses them. However, the number of such instantiations that are useful to provide is limited, and anyway this is not enough, by itself, to minimize compilation time. In particular, it does not reduce time spent parsing conforming headers.

Quicker header parsing will depend on library extensions and compiler improvements. One approach is some variation on the techniques previously marketed as "pre-compiled headers", now standardized as support for the "export" keyword. "Exported" template definitions can be placed (once) in a "repository" -- really just a library, but of template definitions rather than object code -- to be drawn upon at link time when an instantiation is needed, rather than placed in header files to be parsed along with every compilation unit.

Until "export" is implemented we can put some of the lengthy template definitions in #if guards or alternative headers so that users can skip over the full definitions when they need only the ready-instantiated specializations.

To be precise, this means that certain headers which define templates which users normally use only for certain arguments can be instrumented to avoid exposing the template definitions to the compiler unless a macro is defined. For example, in <string>, we might have:

```
template <class _CharT, ... > class basic_string {
... // member declarations
};
... // operator declarations

#ifdef _STRICT_ISO_
# if _G_NO_TEMPLATE_EXPORT
#   include <bits/std_locale.h> // headers needed by definitions
#   ...
#   include <bits/string.tcc> // member and global template definitions.
# endif
#endif
```

Users who compile without specifying a strict-ISO-conforming flag would not see many of the template definitions they now see, and rely instead on ready-instantiated specializations in the library. This technique would be useful for the following substantial components: string, locale/iostreams, valarray. It would *not* be useful or usable with the following: containers, algorithms, iterators, allocator. Since these constitute a large (though decreasing)

fraction of the library, the benefit the technique offers is limited.

The language specifies the semantics of the "export" keyword, but the gcc compiler does not yet support it. When it does, problems with large template inclusions can largely disappear, given some minor library reorganization, along with the need for the apparatus described above.

Overhead: Flexibility Cost

The library offers many places where users can specify operations to be performed by the library in place of defaults. Sometimes this seems to require that the library use a more-roundabout, and possibly slower, way to accomplish the default requirements than would be used otherwise.

The primary protection against this overhead is thorough compiler optimization, to crush out layers of inline function interfaces. Kuck & Associates has demonstrated the practicality of this kind of optimization.

The second line of defense against this overhead is explicit specialization. By defining helper function templates, and writing specialized code for the default case, overhead can be eliminated for that case without sacrificing flexibility. This takes full advantage of any ability of the optimizer to crush out degenerate code.

The library specifies many virtual functions which current linkers load even when they cannot be called. Some minor improvements to the compiler and to ld would eliminate any such overhead by simply omitting virtual functions that the complete program does not call. A prototype of this work has already been done. For targets where GNU ld is not used, a "pre-linker" could do the same job.

The main areas in the standard interface where user flexibility can result in overhead are:

- Allocators: Containers are specified to use user-definable allocator types and objects, making tuning for the container characteristics tricky.
- Locales: the standard specifies locale objects used to implement iostream operations, involving many virtual functions which use streambuf iterators.
- Algorithms and containers: these may be instantiated on any type, frequently duplicating code for identical operations.
- Iostreams and strings: users are permitted to use these on their own types, and specify the operations the stream must use on these types.

Note that these sources of overhead are `_avoidable_`. The techniques to avoid them are covered below.

Code Bloat

In the SGI STL, and in some other headers, many of the templates are defined "inline" -- either explicitly or by their placement in class definitions -- which should not be inline. This is a source of code bloat. Matt had remarked that he was relying on the compiler to recognize what was too big to benefit from inlining, and generate it out-of-line automatically. However, this also can result in code bloat except where the linker can eliminate the extra copies.

Fixing these cases will require an audit of all inline functions defined in the library to determine which merit inlining, and moving the rest out of line. This is an issue mainly in clauses 23, 25, and 27. Of course it can be done incrementally, and we should generally accept patches that move large functions out of line and into ".tcc" files, which can later be pulled into a repository. Compiler/linker improvements to recognize very large inline functions and move them out-of-line, but shared among compilation units, could make this work unnecessary.

Pre-instantiating template specializations currently produces large amounts of dead code which bloats statically linked programs. The current state of the static library, libstdc++.a, is intolerable on this account, and will fuel further confused speculation about a need for a library "subset". A compiler improvement that treats each instantiated function as a separate object file, for linking purposes, would be one solution to this problem. An alternative would be to split up the manual instantiation files into dozens upon dozens of little files, each compiled separately, but an abortive attempt at this was done for <string> and, though it is far from complete, it is already a nuisance. A better interim solution (just until we have "export") is badly needed.

When building a shared library, the current compiler/linker cannot automatically generate the instantiations needed. This creates a miserable situation; it means any time something is changed in the library, before a shared library can be built someone must manually copy the declarations of all templates that are needed by other parts of the library to an "instantiation" file, and add it to the build system to be compiled and linked to the library. This process is readily automated, and should be automated as soon as possible. Users building their own shared libraries experience identical frustrations.

Sharing common aspects of template definitions among instantiations can radically reduce code bloat. The compiler could help a great deal here by recognizing when a function depends on nothing about a template parameter, or only on its size, and giving the resulting function a link-name "equate" that allows it to be shared with other instantiations. Implementation code could take advantage of the capability by factoring out code that does not depend on the template argument into separate functions to be merged by the compiler.

Until such a compiler optimization is implemented, much can be done

manually (if tediously) in this direction. One such optimization is to derive class templates from non-template classes, and move as much implementation as possible into the base class. Another is to partial-specialize certain common instantiations, such as `vector<T*>`, to share code for instantiations on all types `T`. While these techniques work, they are far from the complete solution that a compiler improvement would afford.

Overhead: Expensive Language Features

The main "expensive" language feature used in the standard library is exception support, which requires compiling in cleanup code with static table data to locate it, and linking in library code to use the table. For small embedded programs the amount of such library code and table data is assumed by some to be excessive. Under the "new" ABI this perception is generally exaggerated, although in some cases it may actually be excessive.

To implement a library which does not use exceptions directly is not difficult given minor compiler support (to "turn off" exceptions and ignore exception constructs), and results in no great library maintenance difficulties. To be precise, given `-fno-exceptions`, the compiler should treat `try` blocks as ordinary blocks, and `catch` blocks as dead code to ignore or eliminate. Compiler support is not strictly necessary, except in the case of `function try blocks`; otherwise the following macros almost suffice:

```
#define throw(X)
#define try      if (true)
#define catch(X) else if (false)
```

However, there may be a need to use function try blocks in the library implementation, and use of macros in this way can make correct diagnostics impossible. Furthermore, use of this scheme would require the library to call a function to re-throw exceptions from a try block. Implementing the above semantics in the compiler is preferable.

Given the support above (however implemented) it only remains to replace code that `throws` with a call to a well-documented `handler` function in a separate compilation unit which may be replaced by the user. The main source of exceptions that would be difficult for users to avoid is memory allocation failures, but users can define their own memory allocation primitives that never throw. Otherwise, the complete list of such handlers, and which library functions may call them, would be needed for users to be able to implement the necessary substitutes. (Fortunately, they have the source code.)

Opportunities

The template capabilities of C++ offer enormous opportunities for optimizing common library operations, well beyond what would be considered "eliminating overhead". In particular, many operations done in Glibc with macros that depend on proprietary language

extensions can be implemented in pristine Standard C++. For example, the chapter 25 algorithms, and even C library functions such as `strchr`, can be specialized for the case of static arrays of known (small) size.

Detailed optimization opportunities are identified below where the component where they would appear is discussed. Of course new opportunities will be identified during implementation.

Unimplemented Required Library Features

The standard specifies hundreds of components, grouped broadly by chapter. These are listed in excruciating detail in the CHECKLIST file.

- 17 general
- 18 support
- 19 diagnostics
- 20 utilities
- 21 string
- 22 locale
- 23 containers
- 24 iterators
- 25 algorithms
- 26 numerics
- 27 iostreams
- Annex D backward compatibility

Anyone participating in implementation of the library should obtain a copy of the standard, ISO 14882. People in the U.S. can obtain an electronic copy for US\$18 from ANSI's web site. Those from other countries should visit <http://www.iso.org/> to find out the location of their country's representation in ISO, in order to know who can sell them a copy.

The emphasis in the following sections is on unimplemented features and optimization opportunities.

Chapter 17 General

Chapter 17 concerns overall library requirements.

The standard doesn't mention threads. A multi-thread (MT) extension primarily affects operators `new` and `delete` (18), allocator (20), string (21), locale (22), and iostreams (27). The common underlying support needed for this is discussed under chapter 20.

The standard requirements on names from the C headers create a lot of work, mostly done. Names in the C headers must be visible in the `std::` and sometimes the global namespace; the names in the two scopes must refer to the same object. More stringent is that Koenig lookup implies that any types specified as defined in `std::` really are defined in `std::`. Names optionally implemented as macros in C cannot be macros in C++. (An overview may be read at <http://www.cantrip.org/cheaders.html>). The scripts "inclosure" and "mkcshadow", and the directories `shadow/` and `cshadow/`, are the

beginning of an effort to conform in this area.

A correct conforming definition of C header names based on underlying C library headers, and practical linking of conforming namespaced customer code with third-party C libraries depends ultimately on an ABI change, allowing namespaced C type names to be mangled into type names as if they were global, somewhat as C function names in a namespace, or C++ global variable names, are left unmangled. Perhaps another "extern" mode, such as 'extern "C-global"' would be an appropriate place for such type definitions. Such a type would affect mangling as follows:

```
namespace A {
struct X {};
extern "C-global" { // or maybe just 'extern "C"'
struct Y {};
};
}
void f(A::X*); // mangles to f__FPQ21A1X
void f(A::Y*); // mangles to f__FP1Y
```

(It may be that this is really the appropriate semantics for regular 'extern "C"', and 'extern "C-global"', as an extension, would not be necessary.) This would allow functions declared in non-standard C headers (and thus fixable by neither us nor users) to link properly with functions declared using C types defined in properly-namespaced headers. The problem this solves is that C headers (which C++ programmers do persist in using) frequently forward-declare C struct tags without including the header where the type is defined, as in

```
struct tm;
void munge(tm*);
```

Without some compiler accommodation, munge cannot be called by correct C++ code using a pointer to a correctly-scoped tm* value.

The current C headers use the preprocessor extension "#include_next", which the compiler complains about when run "-pedantic". (Incidentally, it appears that "-fpedantic" is currently ignored, probably a bug.) The solution in the C compiler is to use "-isystem" rather than "-I", but unfortunately in g++ this seems also to wrap the whole header in an 'extern "C"' block, so it's unusable for C++ headers. The correct solution appears to be to allow the various special include-directory options, if not given an argument, to affect subsequent include-directory options additively, so that if one said

```
-pedantic -iprefix $(prefix) \
-idirafter -ino-pedantic -ino-extern-c -iwithprefix -I g++-v3 \
-iwithprefix -I g++-v3/ext
```

the compiler would search \$(prefix)/g++-v3 and not report pedantic warnings for files found there, but treat files in \$(prefix)/g++-v3/ext pedantically. (The undocumented semantics of "-isystem" in g++ stink. Can they be rescinded? If not it must be replaced with something more rationally behaved.)

All the C headers need the treatment above; in the standard these headers are mentioned in various clauses. Below, I have only mentioned those that present interesting implementation issues.

The components identified as "mostly complete", below, have not been audited for conformance. In many cases where the library passes conformance tests we have non-conforming extensions that must be wrapped in #if guards for "pedantic" use, and in some cases renamed in a conforming way for continued use in the implementation regardless of conformance flags.

The STL portion of the library still depends on a header `stl/bits/stl_config.h` full of #ifdef clauses. This apparatus should be replaced with `autoconf/automake` machinery.

The SGI STL defines a `type_traits<>` template, specialized for many types in their code including the built-in numeric and pointer types and some library types, to direct optimizations of standard functions. The SGI compiler has been extended to generate specializations of this template automatically for user types, so that use of STL templates on user types can take advantage of these optimizations. Specializations for other, non-STL, types would make more optimizations possible, but extending the gcc compiler in the same way would be much better. Probably the next round of standardization will ratify this, but probably with changes, so it probably should be renamed to place it in the implementation namespace.

The SGI STL also defines a large number of extensions visible in standard headers. (Other extensions that appear in separate headers have been sequestered in subdirectories `ext/` and `backward/`.) All these extensions should be moved to other headers where possible, and in any case wrapped in a namespace (not `std!`), and (where kept in a standard header) girded about with macro guards. Some cannot be moved out of standard headers because they are used to implement standard features. The canonical method for accommodating these is to use a protected name, aliased in macro guards to a user-space name. Unfortunately C++ offers no satisfactory template typedef mechanism, so very ad-hoc and unsatisfactory aliasing must be used instead.

Implementation of a template typedef mechanism should have the highest priority among possible extensions, on the same level as implementation of the template "export" feature.

Chapter 18 Language support

Headers: `<limits>` `<new>` `<typeinfo>` `<exception>`
C headers: `<cstdint>` `<climits>` `<float>` `<stdint>` `<setjmp>`
`<time>` `<signal>` `<stdlib>` (also 21, 25, 26)

This defines the built-in exceptions, `rtti`, `numeric_limits<>`, operator `new` and `delete`. Much of this is provided by the compiler in its static runtime library.

Work to do includes defining `numeric_limits<>` specializations in

separate files for all target architectures. Values for integer types except for `bool` and `wchar_t` are readily obtained from the C header `<limits.h>`, but values for the remaining numeric types (`bool`, `wchar_t`, `float`, `double`, `long double`) must be entered manually. This is largely dog work except for those members whose values are not easily deduced from available documentation. Also, this involves some work in target configuration to identify the correct choice of file to build against and to install.

The definitions of the various operators `new` and `delete` must be made thread-safe, which depends on a portable exclusion mechanism, discussed under chapter 20. Of course there is always plenty of room for improvements to the speed of operators `new` and `delete`.

`<cstdarg>`, in `Glibc`, defines some macros that `gcc` does not allow to be wrapped into an inline function. Probably this header will demand attention whenever a new target is chosen. The functions `atexit()`, `exit()`, and `abort()` in `cstdlib` have different semantics in C++, so must be re-implemented for C++.

Chapter 19 Diagnostics

Headers: `<stdexcept>`
C headers: `<cassert>` `<cerrno>`

This defines the standard exception objects, which are "mostly complete". Cygnus has a version, and now SGI provides a slightly different one. It makes little difference which we use.

The C global name `"errno"`, which C allows to be a variable or a macro, is required in C++ to be a macro. For MT it must typically result in a function call.

Chapter 20 Utilities

Headers: `<utility>` `<functional>` `<memory>`
C header: `<ctime>` (also in 18)

SGI STL provides "mostly complete" versions of all the components defined in this chapter. However, the `auto_ptr<>` implementation is known to be wrong. Furthermore, the standard definition of it is known to be unimplementable as written. A minor change to the standard would fix it, and `auto_ptr<>` should be adjusted to match.

Multi-threading affects the allocator implementation, and there must be configuration/installation choices for different users' MT requirements. Anyway, users will want to tune allocator options to support different target conditions, MT or no.

The primitives used for MT implementation should be exposed, as an extension, for users' own work. We need cross-CPU "mutex" support, multi-processor shared-memory atomic integer operations, and single-processor uninterruptible integer operations, and all three configurable to be stubbed out for non-MT use, or to use an appropriately-loaded dynamic library for the actual runtime environment, or statically compiled in for cases where the target architecture is known.

Chapter 21 String

Headers: <string>

C headers: <cctype> <cwctype> <cstring> <wchar> (also in 27)

<cstdlib> (also in 18, 25, 26)

We have "mostly-complete" `char_traits<>` implementations. Many of the `char_traits<char>` operations might be optimized further using existing proprietary language extensions.

We have a "mostly-complete" `basic_string<>` implementation. The work to manually instantiate `char` and `wchar_t` specializations in object files to improve link-time behavior is extremely unsatisfactory, literally tripling library-build time with no commensurate improvement in static program link sizes. It must be redone. (Similar work is needed for some components in clauses 22 and 27.)

Other work needed for strings is MT-safety, as discussed under the chapter 20 heading.

The standard C type `mbstate_t` from <wchar> and used in `char_traits<>` must be different in C++ than in C, because in C++ the default constructor value `mbstate_t()` must be the "base" or "ground" sequence state. (According to the likely resolution of a recently raised Core issue, this may become unnecessary. However, there are other reasons to use a state type not as limited as whatever the C library provides.) If we might want to provide conversions from (e.g.) internally-represented EUC-wide to externally-represented Unicode, or vice-versa, the `mbstate_t` we choose will need to be more accommodating than what might be provided by an underlying C library.

There remain some `basic_string` template-member functions which do not overload properly with their non-template brethren. The infamous hack akin to what was done in `vector<>` is needed, to conform to 23.1.1 para 10. The CHECKLIST items for `basic_string` marked 'X', or incomplete, are so marked for this reason.

Replacing the string iterators, which currently are simple character pointers, with class objects would greatly increase the safety of the client interface, and also permit a "debug" mode in which range, ownership, and validity are rigorously checked. The current use of raw pointers as string iterators is evil. `vector<>` iterators need the same treatment. Note that the current implementation freely mixes pointers and iterators, and that must be fixed before safer iterators can be introduced.

Some of the functions in <cstring> are different from the C version. generally overloaded on `const` and `non-const` argument pointers. For example, in <cstring> `strchr` is overloaded. The functions `isupper` etc. in <cctype> typically implemented as macros in C are functions in C++, because they are overloaded with others of the same name defined in <locale>.

Many of the functions required in <cwctype> and <wchar> cannot be implemented using underlying C facilities on intended targets because such facilities only partly exist.

Chapter 22 Locale

Headers: <locale>

C headers: <ctype>

We have a "mostly complete" class `locale`, with the exception of code for constructing, and handling the names of, named locales. The ways that locales are named (particularly when categories (e.g. `LC_TIME`, `LC_COLLATE`) are different) varies among all target environments. This code must be written in various versions and chosen by configuration parameters.

Members of many of the facets defined in `<locale>` are stubs. Generally, there are two sets of facets: the base class facets (which are supposed to implement the "C" locale) and the "byname" facets, which are supposed to read files to determine their behavior. The base `ctype<>`, `collate<>`, and `numput<>` facets are "mostly complete", except that the table of bitmask values used for "is" operations, and corresponding mask values, are still defined in `libio` and just included/linked. (We will need to implement these tables independently, soon, but should take advantage of `libio` where possible.) The `num_put<>::put` members for integer types are "mostly complete".

A complete list of what has and has not been implemented may be found in `CHECKLIST`. However, note that the current definition of `codecvt<wchar_t, char, mbstate_t>` is wrong. It should simply write out the raw bytes representing the wide characters, rather than trying to convert each to a corresponding single "char" value.

Some of the facets are more important than others. Specifically, the members of `ctype<>`, `numput<>`, `num_put<>`, and `num_get<>` facets are used by other library facilities defined in `<string>`, `<istream>`, and `<ostream>`, and the `codecvt<>` facet is used by `basic_filebuf<>` in `<fstream>`, so a conforming `iostream` implementation depends on these.

The "long long" type eventually must be supported, but code mentioning it should be wrapped in `#if` guards to allow pedantic-mode compiling.

Performance of `num_put<>` and `num_get<>` depend critically on caching computed values in `ios_base` objects, and on extensions to the interface with `streambufs`.

Specifically: retrieving a copy of the locale object, extracting the needed facets, and gathering data from them, for each call to (e.g.) `operator<<` would be prohibitively slow. To cache format data for use by `num_put<>` and `num_get<>` we have a `_Format_cache<>` object stored in the `ios_base::pword()` array. This is constructed and initialized lazily, and is organized purely for utility. It is discarded when a new locale with different facets is imbued.

Using only the public interfaces of the iterator arguments to the facet functions would limit performance by forbidding "vector-style" character operations. The `streambuf` iterator optimizations are described under chapter 24, but facets can also bypass the `streambuf` iterators via explicit specializations and operate directly on the

streambufs, and use extended interfaces to get direct access to the streambuf internal buffer arrays. These extensions are mentioned under chapter 27. These optimizations are particularly important for input parsing.

Unused virtual members of locale facets can be omitted, as mentioned above, by a smart linker.

Chapter 23 Containers

Headers: <deque> <list> <queue> <stack> <vector> <map> <set> <bitset>

All the components in chapter 23 are implemented in the SGI STL. They are "mostly complete"; they include a large number of nonconforming extensions which must be wrapped. Some of these are used internally and must be renamed or duplicated.

The SGI components are optimized for large-memory environments. For embedded targets, different criteria might be more appropriate. Users will want to be able to tune this behavior. We should provide ways for users to compile the library with different memory usage characteristics.

A lot more work is needed on factoring out common code from different specializations to reduce code size here and in chapter 25. The easiest fix for this would be a compiler/ABI improvement that allows the compiler to recognize when a specialization depends only on the size (or other gross quality) of a template argument, and allow the linker to share the code with similar specializations. In its absence, many of the algorithms and containers can be partial-specialized, at least for the case of pointers, but this only solves a small part of the problem. Use of a `type_traits`-style template allows a few more optimization opportunities, more if the compiler can generate the specializations automatically.

As an optimization, containers can specialize on the default allocator and bypass it, or take advantage of details of its implementation after it has been improved upon.

Replacing the vector iterators, which currently are simple element pointers, with class objects would greatly increase the safety of the client interface, and also permit a "debug" mode in which range, ownership, and validity are rigorously checked. The current use of pointers for iterators is evil.

As mentioned for chapter 24, the deque iterator is a good example of an opportunity to implement a "staged" iterator that would benefit from specializations of some algorithms.

Chapter 24 Iterators

Headers: <iterator>

Standard iterators are "mostly complete", with the exception of the stream iterators, which are not yet templatized on the stream type. Also, the base class template `iterator<>` appears to be wrong, so everything derived from it must also be wrong,

currently.

The streambuf iterators (currently located in `stl/bits/std_iterator.h`, but should be under `bits/`) can be rewritten to take advantage of friendship with the streambuf implementation.

Matt Austern has identified opportunities where certain iterator types, particularly including streambuf iterators and deque iterators, have a "two-stage" quality, such that an intermediate limit can be checked much more quickly than the true limit on range operations. If identified with a member of `iterator_traits`, algorithms may be specialized for this case. Of course the iterators that have this quality can be identified by specializing a traits class.

Many of the algorithms must be specialized for the streambuf iterators, to take advantage of block-mode operations, in order to allow `iostream/locale` operations' performance not to suffer. It may be that they could be treated as staged iterators and take advantage of those optimizations.

Chapter 25 Algorithms

Headers: `<algorithm>`

C headers: `<cstdlib>` (also in 18, 21, 26)

The algorithms are "mostly complete". As mentioned above, they are optimized for speed at the expense of code and data size.

Specializations of many of the algorithms for non-STL types would give performance improvements, but we must use great care not to interfere with fragile template overloading semantics for the standard interfaces. Conventionally the standard function template interface is an inline which delegates to a non-standard function which is then overloaded (this is already done in many places in the library). Particularly appealing opportunities for the sake of `iostream` performance are for `copy` and `find` applied to streambuf iterators or (as noted elsewhere) for staged iterators, of which the streambuf iterators are a good example.

The `bsearch` and `qsort` functions cannot be overloaded properly as required by the standard because `gcc` does not yet allow overloading on the extern-"C"-ness of a function pointer.

Chapter 26 Numerics

Headers: `<complex>` `<valarray>` `<numeric>`

C headers: `<cmath>`, `<cstdlib>` (also 18, 21, 25)

Numeric components: Gabriel dos Reis's `valarray`, Drepper's `complex`, and the few algorithms from the STL are "mostly done". Of course optimization opportunities abound for the numerically literate. It is not clear whether the `valarray` implementation really conforms fully, in the assumptions it makes about aliasing (and lack thereof) in its arguments.

The C `div()` and `ldiv()` functions are interesting, because they are the

only case where a C library function returns a class object by value. Since the C++ type `div_t` must be different from the underlying C type (which is in the wrong namespace) the underlying functions `div()` and `ldiv()` cannot be re-used efficiently. Fortunately they are trivial to re-implement.

Chapter 27 Iostreams

Headers: `<iosfwd>` `<streambuf>` `<ios>` `<ostream>` `<istream>` `<iostream>`
`<iomanip>` `<sstream>` `<fstream>`
C headers: `<cstdio>` `<wchar>` (also in 21)

Iostream is currently in a very incomplete state. `<iosfwd>`, `<iomanip>`, `ios_base`, and `basic_ios<>` are "mostly complete". `basic_streambuf<>` and `basic_ostream<>` are well along, but `basic_istream<>` has had little work done. The standard stream objects, `<sstream>` and `<fstream>` have been started; `basic_filebuf<>` "write" functions have been implemented just enough to do "hello, world".

Most of the `istream` and `ostream` operators `<<` and `>>` (with the exception of the `op<<(integer) ones`) have not been changed to use locale primitives, sentry objects, or `char_traits` members.

All these templates should be manually instantiated for `char` and `wchar_t` in a way that links only used members into user programs.

`Streambuf` is fertile ground for optimization extensions. An extended interface giving iterator access to its internal buffer would be very useful for other library components.

Iostream operations (primarily operators `<<` and `>>`) can take advantage of the case where user code has not specified a locale, and bypass locale operations entirely. The current implementation of `op<</num_put<>::put`, for the integer types, demonstrates how they can cache encoding details from the locale on each operation. There is lots more room for optimization in this area.

The definition of the relationship between the standard streams `cout` et al. and `stdout` et al. requires something like a "stdiobuf". The SGI solution of using double-indirection to actually use a `stdio FILE` object for buffering is unsatisfactory, because it interferes with peephole loop optimizations.

The `<sstream>` header work has begun. `stringbuf` can benefit from friendship with `basic_string<>` and `basic_string<>::_Rep` to use those objects directly as buffers, and avoid allocating and making copies.

The `basic_filebuf<>` template is a complex beast. It is specified to use the locale facet `codecvt<>` to translate characters between native files and the locale character encoding. In general this involves two buffers, one of "char" representing the file and another of "char_type", for the stream, with `codecvt<>` translating. The process is complicated by the variable-length nature of the translation, and the need to seek to corresponding places in the two representations. For the case of `basic_filebuf<char>`, when no translation is needed, a single buffer suffices. A specialized `filebuf` can be used to reduce

code space overhead when no locale has been imbued. Matt Austern's work at SGI will be useful, perhaps directly as a source of code, or at least as an example to draw on.

Filebuf, almost uniquely (cf. operator new), depends heavily on underlying environmental facilities. In current releases iostream depends fairly heavily on libio constant definitions, but it should be made independent. It also depends on operating system primitives for file operations. There is immense room for optimizations using (e.g.) mmap for reading. The shadow/ directory wraps, besides the standard C headers, the libio.h and unistd.h headers, for use mainly by filebuf. These wrappings have not been completed, though there is scaffolding in place.

The encapsulation of certain C header <stdio> names presents an interesting problem. It is possible to define an inline std::fprintf() implemented in terms of the 'extern "C" vfprintf()', but there is no standard vfscanf() to use to implement std::fscanf(). It appears that vfscanf but be re-implemented in C++ for targets where no vfscanf extension has been defined. This is interesting in that it seems to be the only significant case in the C library where this kind of rewriting is necessary. (Of course Glibc provides the vfscanf() extension.) (The functions related to exit() must be rewritten for other reasons.)

Annex D

Headers: <strstream>

Annex D defines many non-library features, and many minor modifications to various headers, and a complete header. It is "mostly done", except that the libstdc++-2 <strstream> header has not been adopted into the library, or checked to verify that it matches the draft in those details that were clarified by the committee. Certainly it must at least be moved into the std namespace.

We still need to wrap all the deprecated features in #if guards so that pedantic compile modes can detect their use.

Nonstandard Extensions

Headers: <iostream.h> <strstream.h> <hash> <rbtree>
<pthread_alloc> <stdiobuf> (etc.)

User code has come to depend on a variety of nonstandard components that we must not omit. Much of this code can be adopted from libstdc++-v2 or from the SGI STL. This particularly includes <iostream.h>, <strstream.h>, and various SGI extensions such as <hash_map.h>. Many of these are already placed in the subdirectories ext/ and backward/. (Note that it is better to include them via "<backward/hash_map.h>" or "<ext/hash_map>" than to search the subdirectory itself via a "-I" directive.

Appendix B

Porting and Maintenance

B.1 Configure and Build Hacking

B.1.1 Prerequisites

As noted [previously](#), certain other tools are necessary for hacking on files that control `configure` (`configure.ac`, `acinclude.m4`) and `make` (`Makefile.am`). These additional tools (`automake`, and `autoconf`) are further described in detail in their respective manuals. All the libraries in GCC try to stay in sync with each other in terms of versions of the auto-tools used, so please try to play nicely with the neighbors.

B.1.2 Overview

B.1.2.1 General Process

The `configure` process begins the act of building `libstdc++`, and is started via:

```
configure
```

The `configure` file is a script generated (via **autoconf**) from the file `configure.ac`.

After the `configure` process is complete,

```
make all
```

in the build directory starts the build process. The `all` target comes from the `Makefile` file, which is generated via **configure** from the `Makefile.in` file, which is in turn generated (via **automake**) from the file `Makefile.am`.

B.1.2.2 What Comes from Where

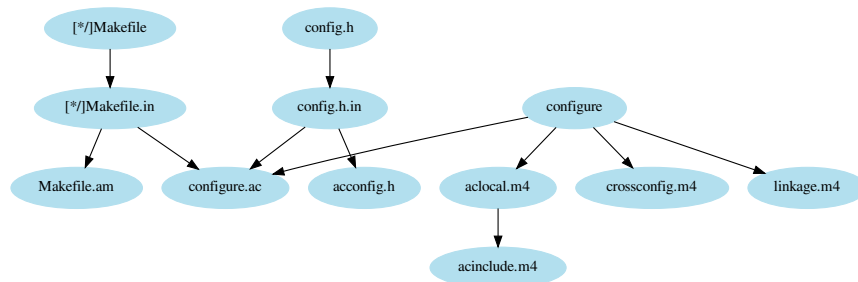

Figure B.1: Configure and Build File Dependencies

Regenerate all generated files by using the command `autoreconf` at the top level of the `libstdc++` source directory.

B.1.3 Configure

B.1.3.1 Storing Information in non-AC files (like `configure.host`)

Until that glorious day when we can use `AC_TRY_LINK` with a cross-compiler, we have to hardcode the results of what the tests would have shown if they could be run. So we have an inflexible mess like `crossconfig.m4`.

Wouldn't it be nice if we could store that information in files like `configure.host`, which can be modified without needing to regenerate anything, and can even be tweaked without really knowing how the configury all works? Perhaps break the pieces of `crossconfig.m4` out and place them in their appropriate `config/{cpu,os}` directory.

Alas, writing macros like `"AC_DEFINE (HAVE_A_NICE_DAY) "` can only be done inside files which are passed through `autoconf`. Files which are pure shell script can be source'd at configure time. Files which contain `autoconf` macros must be processed with `autoconf`. We could still try breaking the pieces out into `"config/*/cross.m4"` bits, for instance, but then we would need arguments to `aclocal/autoconf` to properly find them all when generating `configure`. I would discourage that.

B.1.3.2 Coding and Commenting Conventions

Most comments should use {octothorpes, shibboleths, hash marks, pound signs, whatever} rather than `"dnl"`. Nearly all comments in `configure.ac` should. Comments inside macros written in ancillary `.m4` files should. About the only comments which should *not* use `#`, but use `dnl` instead, are comments *outside* our own macros in the ancillary files. The difference is that `#` comments show up in `configure` (which is most helpful for debugging), while `dnl`'d lines just vanish. Since the macros in ancillary files generate code which appears in odd places, their "outside" comments tend to not be useful while reading `configure`.

Do not use any `$target*` variables, such as `$target_alias`. The single exception is in `configure.ac`, for `automake+dejagnu`'s sake.

B.1.3.3 The `acinclude.m4` layout

The nice thing about `acinclude.m4/aclocal.m4` is that macros aren't actually performed/called/expanded/whatever here, just loaded. So we can arrange the contents however we like. As of this writing, `acinclude.m4` is arranged as follows:

```

GLIBCXX_CHECK_HOST
GLIBCXX_TOPREL_CONFIGURE
GLIBCXX_CONFIGURE

```

All the major variable "discovery" is done here. CXX, multilibs, etc.

```
fragments included from elsewhere
```

Right now, "fragments" == "the math/linkage bits".

```
GLIBCXX_CHECK_COMPILER_FEATURES
GLIBCXX_CHECK_LINKER_FEATURES
GLIBCXX_CHECK_WCHAR_T_SUPPORT
```

Next come extra compiler/linker feature tests. Wide character support was placed here because I couldn't think of another place for it. It will probably get broken apart like the math tests, because we're still disabling wchars on systems which could actually support them.

```
GLIBCXX_CHECK_SETRLIMIT_ancillary
GLIBCXX_CHECK_SETRLIMIT
GLIBCXX_CHECK_S_ISREG_OR_S_IFREG
GLIBCXX_CHECK_POLL
GLIBCXX_CHECK_WRITEV

GLIBCXX_CONFIGURE_TESTSUITE
```

Feature tests which only get used in one place. Here, things used only in the testsuite, plus a couple bits used in the guts of I/O.

```
GLIBCXX_EXPORT_INCLUDES
GLIBCXX_EXPORT_FLAGS
GLIBCXX_EXPORT_INSTALL_INFO
```

Installation variables, multilibs, working with the rest of the compiler. Many of the critical variables used in the makefiles are set here.

```
GLIBGCC_ENABLE
GLIBCXX_ENABLE_C99
GLIBCXX_ENABLE_CHEADERS
GLIBCXX_ENABLE_CLOCALE
GLIBCXX_ENABLE_CONCEPT_CHECKS
GLIBCXX_ENABLE_CSTDIO
GLIBCXX_ENABLE_CXX_FLAGS
GLIBCXX_ENABLE_C_MBCHAR
GLIBCXX_ENABLE_DEBUG
GLIBCXX_ENABLE_DEBUG_FLAGS
GLIBCXX_ENABLE_LONG_LONG
GLIBCXX_ENABLE_PCH
GLIBCXX_ENABLE_SJLJ_EXCEPTIONS
GLIBCXX_ENABLE_SYMVERS
GLIBCXX_ENABLE_THREADS
```

All the features which can be controlled with enable/disable configure options. Note how they're alphabetized now? Keep them like that. :-)

```
AC_LC_MESSAGES
libtool bits
```

Things which we don't seem to use directly, but just has to be present otherwise stuff magically goes wonky.

B.1.3.4 GLIBCXX_ENABLE, the --enable maker

All the GLIBCXX_ENABLE_FOO macros use a common helper, GLIBCXX_ENABLE. (You don't have to use it, but it's easy.) The helper does two things for us:

1. Builds the call to the `AC_ARG_ENABLE` macro, with `--help` text properly quoted and aligned. (Death to changequote!)
2. Checks the result against a list of allowed possibilities, and signals a fatal error if there's no match. This means that the rest of the `GLIBCXX_ENABLE_FOO` macro doesn't need to test for strange arguments, nor do we need to protect against empty/whitespace strings with the `"x$foo" = "xbar"` idiom.

Doing these things correctly takes some extra `autoconf/autom4te` code, which made our macros nearly illegible. So all the ugliness is factored out into this one helper macro.

Many of the macros take an argument, passed from when they are expanded in `configure.ac`. The argument controls the default value of the enable/disable switch. Previously, the arguments themselves had defaults. Now they don't, because that's extra complexity with zero gain for us.

There are three "overloaded signatures". When reading the descriptions below, keep in mind that the brackets are `autoconf`'s quotation characters, and that they will be stripped. Examples of just about everything occur in `acinclude.m4`, if you want to look.

```
GLIBCXX_ENABLE (FEATURE, DEFAULT, HELP-ARG, HELP-STRING)
GLIBCXX_ENABLE (FEATURE, DEFAULT, HELP-ARG, HELP-STRING, permit a|b|c)
GLIBCXX_ENABLE (FEATURE, DEFAULT, HELP-ARG, HELP-STRING, SHELL-CODE-HANDLER)
```

- `FEATURE` is the string that follows `--enable`. The results of the test (such as it is) will be in the variable `$enable_FEATURE`, where `FEATURE` has been squashed. Example: `[extra-foo]`, controlled by the `--enable-extra-foo` option and stored in `$enable_extra_foo`.
- `DEFAULT` is the value to store in `$enable_FEATURE` if the user does not pass `--enable/--disable`. It should be one of the permitted values passed later. Examples: `[yes]`, or `[bar]`, or `[$1]` (which passes the argument given to the `GLIBCXX_ENABLE_FOO` macro as the default).

For cases where we need to probe for particular models of things, it is useful to have an undocumented "auto" value here (see `GLIBCXX_ENABLE_CLOCALE` for an example).

- `HELP-ARG` is any text to append to the option string itself in the `--help` output. Examples: `[]` (i.e., an empty string, which appends nothing), `[=BAR]`, which produces `--enable-extra-foo=BAR`, and `[@<:@=BAR@:>@]`, which produces `--enable-extra-foo[=BAR]`. See the difference? See what it implies to the user?

If you're wondering what that line noise in the last example was, that's how you embed `autoconf` special characters in output text. They're called *quadrigraphs* and you should use them whenever necessary.

- `HELP-STRING` is what you think it is. Do not include the "default" text like we used to do; it will be done for you by `GLIBCXX_ENABLE`. By convention, these are not full English sentences. Example: `[turn on extra foo]`

With no other arguments, only the standard `autoconf` patterns are allowed: `--{enable,disable}-foo[={yes,no}]` The `$enable_FEATURE` variable is guaranteed to equal either "yes" or "no" after the macro. If the user tries to pass something else, an explanatory error message will be given, and `configure` will halt.

The second signature takes a fifth argument, `[permit a | b | c | ...]` This allows `a` or `b` or ... after the equals sign in the option, and `$enable_FEATURE` is guaranteed to equal one of them after the macro. Note that if you want to allow plain `--enable/--disable` with no `"=whatever"`, you must include "yes" and "no" in the list of permitted values. Also note that whatever you passed as `DEFAULT` must be in the list. If the user tries to pass something not on the list, a semi-explanatory error message will be given, and `configure` will halt. Example: `[permit generic|gnu|ieee_1003.1-2001|yes|no|auto]`

The third signature takes a fifth argument. It is arbitrary shell code to execute if the user actually passes the enable/disable option. (If the user does not, the default is used. Duh.) No argument checking at all is done in this signature. See `GLIBCXX_ENABLE_CXX_FLAGS` for an example of handling, and an error message.

B.1.4 Make

The build process has to make all of object files needed for static or shared libraries, but first it has to generate some include files. The general order is as follows:

1. make include files, make pre-compiled headers
2. make libsupc++

Generates a libtool convenience library, `libsupc++convenience` with language-support routines. Also generates a freestanding static library, `libsupc++.a`.

3. make src

Generates two convenience libraries, one for C++98 and one for C++11, various compatibility files for shared and static libraries, and then collects all the generated bits and creates the final `libstdc++` libraries.

- (a) make src/c++98

Generates a libtool convenience library, `libc++98convenience` with language-support routines. Uses the `-std=gnu++98` dialect.

- (b) make src/c++11

Generates a libtool convenience library, `libc++11convenience` with language-support routines. Uses the `-std=gnu++11` dialect.

- (c) make src

Generates needed compatibility objects for shared and static libraries. Shared-only code is segregated at compile-time via the macro `_GLIBCXX_SHARED`.

Then, collects all the generated convenience libraries, adds in any required compatibility objects, and creates the final shared and static libraries: `libstdc++.so` and `libstdc++.a`.

B.2 Writing and Generating Documentation

B.2.1 Introduction

Documentation for the GNU C++ Library is created from three independent sources: a manual, a FAQ, and an API reference.

The sub-directory `doc` within the main source directory contains `Makefile.am` and `Makefile.in`, which provide rules for generating documentation, described in excruciating detail below. The `doc` sub-directory also contains three directories: `doxygen`, which contains scripts and fragments for **doxygen**, `html`, which contains an html version of the manual, and `xml`, which contains an xml version of the manual.

Diverging from established documentation conventions in the rest of the GCC project, `libstdc++` does not use Texinfo as a markup language. Instead, Docbook is used to create the manual and the FAQ, and Doxygen is used to construct the API reference. Although divergent, this conforms to the GNU Project recommendations as long as the output is of sufficient quality, as per [GNU Manuals](#).

B.2.2 Generating Documentation

Certain Makefile rules are required by the GNU Coding Standards. These standard rules generate HTML, PDF, XML, or man files. For each of the generative rules, there is an additional install rule that is used to install any generated documentation files into the prescribed installation directory. Files are installed into `share/doc` or `share/man` directories.

The standard Makefile rules are conditionally supported, based on the results of examining the host environment for prerequisites at configuration time. If requirements are not found, the rule is aliased to a dummy rule that does nothing, and produces no documentation. If the requirements are found, the rule forwards to a private rule that produces the requested documentation.

For more details on what prerequisites were found and where, please consult the file `config.log` in the `libstdc++` build directory. Compare this log to what is expected for the relevant Makefile conditionals: `BUILD_INFO`, `BUILD_XML`, `BUILD_HTML`, `BUILD_MAN`, `BUILD_PDF`, and `BUILD_EPUB`.

Supported Makefile rules:

make html, **make install-html** Generates multi-page HTML documentation, and installs it in the following directories:

```
doc/libstdc++/libstdc++-api.html
doc/libstdc++/libstdc++-manual.html
```

make pdf, **make install-pdf** Generates indexed PDF documentation, and installs it as the following files:

```
doc/libstdc++/libstdc++-api.pdf
doc/libstdc++/libstdc++-manual.pdf
```

make man, **make install-man** Generates man pages, and installs it in the following directory:

```
man/man3/
```

The generated man pages are namespace-qualified, so to look at the man page for `vector`, one would use **man std::vector**.

make epub, **make install-epub** Generates documentation in the ebook/portable electronic reader format called Epub, and installs it as the following file.

```
doc/libstdc++/libstdc++-manual.epub
```

make xml, **make install-xml** Generates single-file XML documentation, and installs it as the following files:

```
doc/libstdc++/libstdc++-api-single.xml
doc/libstdc++/libstdc++-manual-single.xml
```

Makefile rules for several other formats are explicitly not supported, and are always aliased to dummy rules. These unsupported formats are: *info*, *ps*, and *dvi*.

B.2.3 Doxygen

B.2.3.1 Prerequisites

Tool	Version	Required By
coreutils	8.5	all
bash	4.1	all
doxygen	1.7.6.1	all
graphviz	2.26	graphical hierarchies
pdflatex	2007-59	pdf output

Table B.1: Doxygen Prerequisites

Prerequisite tools are Bash 2.0 or later, [Doxygen](#), and the [GNU coreutils](#). (GNU versions of `find`, `xargs`, and possibly `sed` and `grep` are used, just because the GNU versions make things very easy.)

To generate the pretty pictures and hierarchy graphs, the [Graphviz](#) package will need to be installed. For PDF output, [pdflatex](#) is required.

Be warned the PDF file generated via doxygen is extremely large. At last count, the PDF file is over three thousand pages. Generating this document taxes the underlying TeX formatting system, and will require the expansion of TeX's memory capacity. Specifically, the `pool_size` variable in the configuration file `texmf.cnf` may need to be increased by a minimum factor of two.

B.2.3.2 Generating the Doxygen Files

The following Makefile rules run Doxygen to generate HTML docs, XML docs, XML docs as a single file, PDF docs, and the man pages. These rules are not conditional! If the required tools are not found, or are the wrong versions, the rule may end in an error.

```
make doc-html-doxygen
```

```
make doc-xml-doxygen
```

```
make doc-xml-single-doxygen
```

```
make doc-pdf-doxygen
```

```
make doc-man-doxygen
```

Generated files are output into separate sub directories of `doc/doxygen/` in the build directory, based on the output format. For instance, the HTML docs will be in `doc/doxygen/html`.

Careful observers will see that the Makefile rules simply call a script from the source tree, `run_doxygen`, which does the actual work of running Doxygen and then (most importantly) massaging the output files. If for some reason you prefer to not go through the Makefile, you can call this script directly. (Start by passing `--help`.)

If you wish to tweak the Doxygen settings, do so by editing `doc/doxygen/user.cfg.in`. Notes to fellow library hackers are written in triple-`#` comments.

B.2.3.3 Debugging Generation

Sometimes, mis-configuration of the pre-requisite tools can lead to errors when attempting to build the documentation. Here are some of the obvious errors, and ways to fix some common issues that may appear quite cryptic.

First, if using a rule like `make pdf`, try to narrow down the scope of the error to either `docbook` (`make doc-pdf-docbook`) or `doxygen` (`make doc-pdf-doxygen`).

Working on the doxygen path only, closely examine the contents of the following build directory: `build/target/libstdc++-v3/doc/doxygen/latex`. Pay attention to three files enclosed within, annotated as follows.

- *refman.tex*

The actual latex file, or partial latex file. This is generated via **doxygen**, and is the LaTeX version of the Doxygen XML file `libstdc++-api.xml`. Go to a specific line, and look at the generated LaTeX, and try to deduce what markup in `libstdc++-api.xml` is causing it.

- *refman.out*

A log of the compilation of the converted LaTeX form to pdf. This is a linear list, from the beginning of the `refman.tex` file: the last entry of this file should be the end of the LaTeX file. If it is truncated, then you know that the last entry is the last part of the generated LaTeX source file that is valid. Often this file contains an error with a specific line number of `refman.tex` that is incorrect, or will have clues at the end of the file with the dump of the memory usage of LaTeX.

If the error at hand is not obvious after examination, a fall-back strategy is to start commenting out the doxygen input sources, which can be found in `doc/doxygen/user.cfg.in`, look for the `INPUT` tag. Start by commenting out whole directories of header files, until the offending header is identified. Then, read the latex log files to try and find surround text, and look for that in the offending header.

B.2.3.4 Markup

In general, `libstdc++` files should be formatted according to the rules found in the [Coding Standard](#). Before any doxygen-specific formatting tweaks are made, please try to make sure that the initial formatting is sound.

Adding Doxygen markup to a file (informally called “doxygenating”) is very simple. The Doxygen manual can be found [here](#). We try to use a very-recent version of Doxygen.

For classes, use `deque/vector/list` and `std::pair` as examples. For functions, see their member functions, and the free functions in `stl_algobase.h`. Member functions of other container-like types should read similarly to these member functions.

Some commentary to accompany the first list in the [Special Documentation Blocks](#) section of the Doxygen manual:

1. For longer comments, use the Javadoc style...
2. ...not the Qt style. The intermediate *'s are preferred.
3. Use the triple-slash style only for one-line comments (the “brief” mode).
4. This is disgusting. Don't do this.

Some specific guidelines:

Use the @-style of commands, not the !-style. Please be careful about whitespace in your markup comments. Most of the time it doesn't matter; doxygen absorbs most whitespace, and both HTML and *roff are agnostic about whitespace. However, in <pre> blocks and @code/@endcode sections, spacing can have “interesting” effects.

Use either kind of grouping, as appropriate. `doxygroups.cc` exists for this purpose. See `stl_iterator.h` for a good example of the “other” kind of grouping.

Please use markup tags like @p and @a when referring to things such as the names of function parameters. Use @e for emphasis when necessary. Use @c to refer to other standard names. (Examples of all these abound in the present code.)

Complicated math functions should use the multi-line format. An example from `random.h`:

```
/**
 * @brief A model of a linear congruential random number generator.
 *
 * @f[
 *   x_{i+1} \leftarrow (ax_{i} + c) \bmod m
 * @f]
 */
```

One area of note is the markup required for @file markup in header files. Two details are important: for filenames that have the same name in multiple directories, include part of the installed path to disambiguate. For example:

```
/** @file debug/vector
 * This file is a GNU debug extension to the Standard C++ Library.
 */
```

The other relevant detail for header files is the use of a libstdc++-specific doxygen alias that helps distinguish between public header files (like `random`) from implementation or private header files (like `bits/c++config.h`.) This alias is spelled @headername and can take one or two arguments that detail the public header file or files that should be included to use the contents of the file. All header files that are not intended for direct inclusion must use headername in the file block. An example:

```
/** @file bits/basic_string.h
 * This is an internal header file, included by other library headers.
 * Do not attempt to use it directly. @headername{string}
 */
```

Be careful about using certain, special characters when writing Doxygen comments. Single and double quotes, and separators in filenames are two common trouble spots. When in doubt, consult the following table.

B.2.4 Docbook

B.2.4.1 Prerequisites

Editing the DocBook sources requires an XML editor. Many exist: some notable options include **emacs**, Kate, or Conglomerate.

Some editors support special “XML Validation” modes that can validate the file as it is produced. Recommended is the **nXML Mode** for **emacs**.

HTML	Doxygen
\	\\
"	\"
'	\'
<i>	@a word
	@b word
<code>	@c word
	@a word
	two words or more

Table B.2: HTML to Doxygen Markup Comparison

Tool	Version	Required By
docbook5-style-xsl	1.76.1	all
xsltproc	1.1.26	all
xmllint	2.7.7	validation
dblatex	0.3	pdf output
pdflatex	2007-59	pdf output
docbook2X	0.8.8	info output
epub3 stylesheets	b3	epub output

Table B.3: Docbook Prerequisites

Besides an editor, additional DocBook files and XML tools are also required.

Access to the DocBook 5.0 stylesheets and schema is required. The stylesheets are usually packaged by vendor, in something like `docbook5-style-xsl`. To exactly match generated output, please use a version of the stylesheets equivalent to `docbook5-style-xsl-1.75.2-3`. The installation directory for this package corresponds to the `XSL_STYLE_DIR` in `doc/Makefile.am` and defaults to `/usr/share/sgml/docbook/xsl-ns-stylesheets`.

For processing XML, an XSLT processor and some style sheets are necessary. Defaults are `xsltproc` provided by `libxslt`.

For validating the XML document, you'll need something like `xmllint` and access to the relevant DocBook schema. These are provided by a vendor package like `libxml2` and `docbook5-schemas-5.0-4`

For PDF output, something that transforms valid Docbook XML to PDF is required. Possible solutions include `dblatex`, `xmllto`, or `prince`. Of these, `dblatex` is the default. Other options are listed on the DocBook web [pages](#). Please consult the [libstdc++@gcc.gnu.org](#) list when preparing printed manuals for current best practice and suggestions.

For Texinfo output, something that transforms valid Docbook XML to Texinfo is required. The default choice is `docbook2X`.

For epub output, the [stylesheets](#) for EPUB3 are required. These stylesheets are still in development. To validate the created file, `epubcheck` is necessary.

B.2.4.2 Generating the DocBook Files

The following Makefile rules generate (in order): an HTML version of all the DocBook documentation, a PDF version of the same, and a single XML document. These rules are not conditional! If the required tools are not found, or are the wrong versions, the rule may end in an error.

```
make doc-html-docbook
```

```
make doc-pdf-docbook
```

```
make doc-xml-single-docbook
```

Generated files are output into separate sub directories of `doc/docbook/` in the build directory, based on the output format. For instance, the HTML docs will be in `doc/docbook/html`.

If the Docbook stylesheets are installed in a custom location, one can use the variable `XSL_STYLE_DIR` to override the Makefile defaults. For example:

```
make XSL_STYLE_DIR="/usr/share/xml/docbook/stylesheet/nwalsh" doc-html-docbook
```

B.2.4.3 Debugging Generation

Sometimes, mis-configuration of the pre-requisite tools can lead to errors when attempting to build the documentation. Here are some of the obvious errors, and ways to fix some common issues that may appear quite cryptic.

First, if using a rule like `make pdf`, try to narrow down the scope of the error to either `docbook` (`make doc-pdf-docbook`) or `doxygen` (`make doc-pdf-doxygen`).

Working on the `docbook` path only, closely examine the contents of the following build directory: `build/target/libstdc++-v3/doc/docbook/latex`. Pay attention to three files enclosed within, annotated as follows.

- *spine.tex*

The actual latex file, or partial latex file. This is generated via **dblatex**, and is the LaTeX version of the DocBook XML file `spine.xml`. Go to a specific line, and look at the generated LaTeX, and try to deduce what markup in `spine.xml` is causing it.

- *spine.out*

A log of the conversion from the XML form to the LaTeX form. This is a linear list, from the beginning of the `spine.xml` file: the last entry of this file should be the end of the DocBook file. If it is truncated, then you know that the last entry is the last part of the XML source file that is valid. The error is after this point.

- *spine.log*

A log of the compilation of the converted LaTeX form to pdf. This is a linear list, from the beginning of the `spine.tex` file: the last entry of this file should be the end of the LaTeX file. If it is truncated, then you know that the last entry is the last part of the generated LaTeX source file that is valid. Often this file contains an error with a specific line number of `spine.tex` that is incorrect.

If the error at hand is not obvious after examination, or if one encounters the inscrutable “Incomplete `\ifmmode`” error, a fall-back strategy is to start commenting out parts of the XML document (regardless of what this does to over-all document validity). Start by commenting out each of the largest parts of the `spine.xml` file, section by section, until the offending section is identified.

B.2.4.4 Editing and Validation

After editing the xml sources, please make sure that the XML documentation and markup is still valid. This can be done easily, with the following validation rule:

```
make doc-xml-validate-docbook
```

This is equivalent to doing:

```
xmllint --noout --valid xml/index.xml
```

Please note that individual sections and chapters of the manual can be validated by substituting the file desired for `xml/index.xml` in the command above. Reducing scope in this manner can be helpful when validation on the entire manual fails.

All Docbook xml sources should always validate. No excuses!

B.2.4.5 File Organization and Basics

Which files are important

All Docbook files are in the directory
libstdc++-v3/doc/xml

Inside this directory, the files of importance:

spine.xml - index to documentation set
manual/spine.xml - index to manual
manual/*.xml - individual chapters and sections of the manual
faq.xml - index to FAQ
api.xml - index to source level / API

All *.txml files are template xml files, i.e., otherwise empty files with the correct structure, suitable for filling in with new information.

Canonical Writing Style

class template
function template
member function template
(via C++ Templates, Vandevoorde)

class in namespace std: allocator, not std::allocator

header file: iostream, not <iostream>

General structure

```
<set>  
<book>  
</book>
```

```
<book>  
<chapter>  
</chapter>  
</book>
```

```
<book>  
<part>  
<chapter>  
<section>  
</section>
```

```
<sect1>  
</sect1>
```

```
<sect1>  
<sect2>  
</sect2>  
</sect1>  
</chapter>
```

```
<chapter>  
</chapter>
```

```

</part>
</book>

</set>

```

B.2.4.6 Markup By Example

Complete details on Docbook markup can be found in the DocBook Element Reference, [online](#). An incomplete reference for HTML to Docbook conversion is detailed in the table below.

HTML	Docbook
<p>	<para>
<pre>	<computeroutput>, <programlisting>, <literallayout>
	<itemizedlist>
	<orderedlist>
	<listitem>
<dl>	<variablelist>
<dt>	<term>
<dd>	<listitem>
	<ulink url="">
<code>	<literal>, <programlisting>
	<emphasis>
	<emphasis>
"	<quote>

Table B.4: HTML to Docbook XML Markup Comparison

And examples of detailed markup for which there are no real HTML equivalents are listed in the table below.

Element	Use
<structname>	<structname>char_traits</structname>
<classname>	<classname>string</classname>
<function>	<function>clear()</function> <function>fs.clear()</function>
<type>	<type>long long</type>
<varname>	<varname>fs</varname>
<literal>	<literal>-Weffc++</literal> <literal>rel_ops</literal>
<constant>	<constant>_GNU_SOURCE</constant> <constant>3.0</constant>
<command>	<command>g++</command>
<errortext>	<errortext>In instantiation of</errortext>
<filename>	<filename class="headerfile">ctype.h</filename> <filename class="directory">/home/gcc/build</filename> <filename class="libraryfile">libstdc++.so</filename>

Table B.5: Docbook XML Element Use

B.3 Porting to New Hardware or Operating Systems

This document explains how to port libstdc++ (the GNU C++ library) to a new target.

In order to make the GNU C++ library (libstdc++) work with a new target, you must edit some configuration files and provide some new header files. Unless this is done, libstdc++ will use generic settings which may not be correct for your target; even if they are correct, they will likely be inefficient.

Before you get started, make sure that you have a working C library on your target. The C library need not precisely comply with any particular standard, but should generally conform to the requirements imposed by the ANSI/ISO standard.

In addition, you should try to verify that the C++ compiler generally works. It is difficult to test the C++ compiler without a working library, but you should at least try some minimal test cases.

(Note that what we think of as a "target," the library refers to as a "host." The comment at the top of `configure.ac` explains why.)

B.3.1 Operating System

If you are porting to a new operating system (as opposed to a new chip using an existing operating system), you will need to create a new directory in the `config/os` hierarchy. For example, the IRIX configuration files are all in `config/os/irix`. There is no set way to organize the OS configuration directory. For example, `config/os/solaris/solaris-2.6` and `config/os/solaris/solaris-2.7` are used as configuration directories for these two versions of Solaris. On the other hand, both Solaris 2.7 and Solaris 2.8 use the `config/os/solaris/solaris-2.7` directory. The important information is that there needs to be a directory under `config/os` to store the files for your operating system.

You might have to change the `configure.host` file to ensure that your new directory is activated. Look for the switch statement that sets `os_include_dir`, and add a pattern to handle your operating system if the default will not suffice. The switch statement switches on only the OS portion of the standard target triplet; e.g., the `solaris2.8` in `sparc-sun-solaris2.8`. If the new directory is named after the OS portion of the triplet (the default), then nothing needs to be changed.

The first file to create in this directory, should be called `os_defines.h`. This file contains basic macro definitions that are required to allow the C++ library to work with your C library.

Several libstdc++ source files unconditionally define the macro `_POSIX_SOURCE`. On many systems, defining this macro causes large portions of the C library header files to be eliminated at preprocessing time. Therefore, you may have to `#undef` this macro, or define other macros (like `_LARGEFILE_SOURCE` or `__EXTENSIONS__`). You won't know what macros to define or undefine at this point; you'll have to try compiling the library and seeing what goes wrong. If you see errors about calling functions that have not been declared, look in your C library headers to see if the functions are declared there, and then figure out what macros you need to define. You will need to add them to the `CPLUSPLUS_CPP_SPEC` macro in the GCC configuration file for your target. It will not work to simply define these macros in `os_defines.h`.

At this time, there are a few libstdc++-specific macros which may be defined:

`_GLIBCXX_USE_C99_CHECK` may be defined to 1 to check C99 function declarations (which are not covered by specialization below) found in system headers against versions found in the library headers derived from the standard.

`_GLIBCXX_USE_C99_DYNAMIC` may be defined to an expression that yields 0 if and only if the system headers are exposing proper support for C99 functions (which are not covered by specialization below). If defined, it must be 0 while bootstrapping the compiler/rebuilding the library.

`_GLIBCXX_USE_C99_LONG_LONG_CHECK` may be defined to 1 to check the set of C99 long long function declarations found in system headers against versions found in the library headers derived from the standard.

`_GLIBCXX_USE_C99_LONG_LONG_DYNAMIC` may be defined to an expression that yields 0 if and only if the system headers are exposing proper support for the set of C99 long long functions. If defined, it must be 0 while bootstrapping the compiler/rebuilding the library.

`_GLIBCXX_USE_C99_FP_MACROS_DYNAMIC` may be defined to an expression that yields 0 if and only if the system headers are exposing proper support for the related set of macros. If defined, it must be 0 while bootstrapping the compiler/rebuilding the library.

`_GLIBCXX_USE_C99_FLOAT_TRANSCENDENTALS_CHECK` may be defined to 1 to check the related set of function declarations found in system headers against versions found in the library headers derived from the standard.

`_GLIBCXX_USE_C99_FLOAT_TRANSCENDENTALS_DYNAMIC` may be defined to an expression that yields 0 if and only if the system headers are exposing proper support for the related set of functions. If defined, it must be 0 while bootstrapping the compiler/rebuilding the library.

Finally, you should bracket the entire file in an include-guard, like this:

```
#ifndef _GLIBCXX_OS_DEFINES
#define _GLIBCXX_OS_DEFINES
...
#endif
```

We recommend copying an existing `os_defines.h` to use as a starting point.

B.3.2 CPU

If you are porting to a new chip (as opposed to a new operating system running on an existing chip), you will need to create a new directory in the `config/cpu` hierarchy. Much like the [Operating system](#) setup, there are no strict rules on how to organize the CPU configuration directory, but careful naming choices will allow the configury to find your setup files without explicit help.

We recommend that for a target triplet `<CPU>-<vendor>-<OS>`, you name your configuration directory `config/cpu/<CPU>`. If you do this, the configury will find the directory by itself. Otherwise you will need to edit the `configure.host` file and, in the switch statement that sets `cpu_include_dir`, add a pattern to handle your chip.

Note that some chip families share a single configuration directory, for example, `alpha`, `alphaev5`, and `alphaev6` all use the `config/cpu/alpha` directory, and there is an entry in the `configure.host` switch statement to handle this.

The `cpu_include_dir` sets default locations for the files controlling [Thread safety](#) and [Numeric limits](#), if the defaults are not appropriate for your chip.

B.3.3 Character Types

The library requires that you provide three header files to implement character classification, analogous to that provided by the C libraries `<ctype.h>` header. You can model these on the files provided in `config/os/generic`. However, these files will almost certainly need some modification.

The first file to write is `ctype_base.h`. This file provides some very basic information about character classification. The `libstdc++` library assumes that your C library implements `<ctype.h>` by using a table (indexed by character code) containing integers, where each of these integers is a bit-mask indicating whether the character is upper-case, lower-case, alphabetic, etc. The `ctype_base.h` file gives the type of the integer, and the values of the various bit masks. You will have to peer at your own `<ctype.h>` to figure out how to define the values required by this file.

The `ctype_base.h` header file does not need include guards. It should contain a single `struct` definition called `ctype_base`. This `struct` should contain two type declarations, and one enumeration declaration, like this example, taken from the IRIX configuration:

```
struct ctype_base
{
    typedef unsigned int    mask;
    typedef int*           __to_type;

    enum
    {
        space = _ISspace,
        print = _ISprint,
        cntrl = _IScntrl,
        upper = _ISupper,
        lower = _ISlower,
        alpha = _ISalpha,
        digit = _ISdigit,
        punct = _ISpunct,
        xdigit = _ISxdigit,
        alnum = _ISalnum,
        graph = _ISgraph
    };
};
```

The `mask` type is the type of the elements in the table. If your C library uses a table to map lower-case numbers to upper-case numbers, and vice versa, you should define `__to_type` to be the type of the elements in that table. If you don't mind taking a minor performance penalty, or if your library doesn't implement `toupper` and `tolower` in this way, you can pick any pointer-to-integer type, but you must still define the type.

The enumeration should give definitions for all the values in the above example, using the values from your native `<ctype.h>`. They can be given symbolically (as above), or numerically, if you prefer. You do not have to include `<ctype.h>` in this header; it will always be included before `ctype_base.h` is included.

The next file to write is `ctype_configure_char.cc`. The first function that must be written is the `ctype<char>::ctype` constructor. Here is the IRIX example:

```
ctype<char>::ctype(const mask* __table = 0, bool __del = false,
                 size_t __refs = 0)
    : _Ctype_nois<char>(__refs), _M_del(__table != 0 && __del),
      _M_toupper(NULL),
      _M_tolower(NULL),
      _M_ctable(NULL),
      _M_table(!__table
               ? (const mask*) (__libc_attr._ctype_tbl->_class + 1)
               : __table)
    { }
```

There are two parts of this that you might choose to alter. The first, and most important, is the line involving `__libc_attr`. That is IRIX system-dependent code that gets the base of the table mapping character codes to attributes. You need to substitute code that obtains the address of this table on your system. If you want to use your operating system's tables to map upper-case letters to lower-case, and vice versa, you should initialize `_M_toupper` and `_M_tolower` with those tables, in similar fashion.

Now, you have to write two functions to convert from upper-case to lower-case, and vice versa. Here are the IRIX versions:

```
char
ctype<char>::do_toupper(char __c) const
{ return _toupper(__c); }

char
ctype<char>::do_tolower(char __c) const
{ return _tolower(__c); }
```

Your C library provides equivalents to IRIX's `_toupper` and `_tolower`. If you initialized `_M_toupper` and `_M_tolower` above, then you could use those tables instead.

Finally, you have to provide two utility functions that convert strings of characters. The versions provided here will always work - but you could use specialized routines for greater performance if you have machinery to do that on your system:

```
const char*
ctype<char>::do_toupper(char* __low, const char* __high) const
{
    while (__low < __high)
    {
        *__low = do_toupper(*__low);
        ++__low;
    }
    return __high;
}

const char*
ctype<char>::do_tolower(char* __low, const char* __high) const
{
    while (__low < __high)
    {
        *__low = do_tolower(*__low);
        ++__low;
    }
}
```

```
    return __high;
}
```

You must also provide the `ctype_inline.h` file, which contains a few more functions. On most systems, you can just copy `config/os/generic/ctype_inline.h` and use it on your system.

In detail, the functions provided test characters for particular properties; they are analogous to the functions like `isalpha` and `islower` provided by the C library.

The first function is implemented like this on IRIX:

```
bool
ctype<char>::
is(mask __m, char __c) const throw()
{ return (_M_table)[(unsigned char)(__c)] & __m; }
```

The `_M_table` is the table passed in above, in the constructor. This is the table that contains the bitmasks for each character. The implementation here should work on all systems.

The next function is:

```
const char*
ctype<char>::
is(const char* __low, const char* __high, mask* __vec) const throw()
{
    while (__low < __high)
        *__vec++ = (_M_table)[(unsigned char)(*__low++)];
    return __high;
}
```

This function is similar; it copies the masks for all the characters from `__low` up until `__high` into the vector given by `__vec`.

The last two functions again are entirely generic:

```
const char*
ctype<char>::
scan_is(mask __m, const char* __low, const char* __high) const throw()
{
    while (__low < __high && !this->is(__m, *__low))
        ++__low;
    return __low;
}

const char*
ctype<char>::
scan_not(mask __m, const char* __low, const char* __high) const throw()
{
    while (__low < __high && this->is(__m, *__low))
        ++__low;
    return __low;
}
```

B.3.4 Thread Safety

The C++ library string functionality requires a couple of atomic operations to provide thread-safety. If you don't take any special action, the library will use stub versions of these functions that are not thread-safe. They will work fine, unless your applications are multi-threaded.

If you want to provide custom, safe, versions of these functions, there are two distinct approaches. One is to provide a version for your CPU, using assembly language constructs. The other is to use the thread-safety primitives in your operating system. In either case, you make a file called `atomicity.h`, and the variable `ATOMICITYH` must point to this file.

If you are using the assembly-language approach, put this code in `config/cpu/<chip>/atomicity.h`, where `chip` is the name of your processor (see [CPU](#)). No additional changes are necessary to locate the file in this case; `ATOMICITYH` will be set by default.

If you are using the operating system thread-safety primitives approach, you can also put this code in the same CPU directory, in which case no more work is needed to locate the file. For examples of this approach, see the `atomicity.h` file for IRIX or IA64.

Alternatively, if the primitives are more closely related to the OS than they are to the CPU, you can put the `atomicity.h` file in the [Operating system](#) directory instead. In this case, you must edit `configure.host`, and in the switch statement that handles operating systems, override the `ATOMICITYH` variable to point to the appropriate `os_include_dir`. For examples of this approach, see the `atomicity.h` file for AIX.

With those bits out of the way, you have to actually write `atomicity.h` itself. This file should be wrapped in an include guard named `_GLIBCXX_ATOMICITY_H`. It should define one type, and two functions.

The type is `_Atomic_word`. Here is the version used on IRIX:

```
typedef long _Atomic_word;
```

This type must be a signed integral type supporting atomic operations. If you're using the OS approach, use the same type used by your system's primitives. Otherwise, use the type for which your CPU provides atomic primitives.

Then, you must provide two functions. The bodies of these functions must be equivalent to those provided here, but using atomic operations:

```
static inline _Atomic_word
__attribute__((__unused__))
__exchange_and_add (_Atomic_word* __mem, int __val)
{
    _Atomic_word __result = *__mem;
    *__mem += __val;
    return __result;
}

static inline void
__attribute__((__unused__))
__atomic_add (_Atomic_word* __mem, int __val)
{
    *__mem += __val;
}
```

B.3.5 Numeric Limits

The C++ library requires information about the fundamental data types, such as the minimum and maximum representable values of each type. You can define each of these values individually, but it is usually easiest just to indicate how many bits are used in each of the data types and let the library do the rest. For information about the macros to define, see the top of `include/bits/std_limits.h`.

If you need to define any macros, you can do so in `os_defines.h`. However, if all operating systems for your CPU are likely to use the same values, you can provide a CPU-specific file instead so that you do not have to provide the same definitions for each operating system. To take that approach, create a new file called `cpu_limits.h` in your CPU configuration directory (see [CPU](#)).

B.3.6 Libtool

The C++ library is compiled, archived and linked with libtool. Explaining the full workings of libtool is beyond the scope of this document, but there are a few, particular bits that are necessary for porting.

Some parts of the `libstdc++` library are compiled with the libtool `--tags CXX` option (the C++ definitions for libtool). Therefore, `ltcf-cxx.sh` in the top-level directory needs to have the correct logic to compile and archive objects equivalent to the C

version of libtool, `ltcf-c.sh`. Some libtool targets have definitions for C but not for C++, or C++ definitions which have not been kept up to date.

The C++ run-time library contains initialization code that needs to be run as the library is loaded. Often, that requires linking in special object files when the C++ library is built as a shared library, or taking other system-specific actions.

The `libstdc++` library is linked with the C version of libtool, even though it is a C++ library. Therefore, the C version of libtool needs to ensure that the run-time library initializers are run. The usual way to do this is to build the library using `gcc -shared`.

If you need to change how the library is linked, look at `ltcf-c.sh` in the top-level directory. Find the switch statement that sets `archive_cmds`. Here, adjust the setting for your operating system.

B.4 Test

The `libstdc++` testsuite includes testing for standard conformance, regressions, ABI, and performance.

B.4.1 Organization

B.4.1.1 Directory Layout

The directory `libsrcdir/testsuite` contains the individual test cases organized in sub-directories corresponding to clauses of the C++ standard (detailed below), the dejagnu test harness support files, and sources to various testsuite utilities that are packaged in a separate testing library.

All test cases for functionality required by the runtime components of the C++ standard (ISO 14882) are files within the following directories.

```
17_intro
18_support
19_diagnostics
20_util
21_strings
22_locale
23_containers
25_algorithms
26_numerics
27_io
28_regex
29_atomics
30_threads
```

In addition, the following directories include test files:

```
tr1      Tests for components as described by the Technical Report on Standard Library ←
         Extensions (TR1).
backward Tests for backwards compatibility and deprecated features.
demangle Tests for __cxa_demangle, the IA 64 C++ ABI demangler
ext      Tests for extensions.
performance Tests for performance analysis, and performance regressions.
```

Some directories don't have test files, but instead contain auxiliary information:

```
config   Files for the dejagnu test harness.
lib      Files for the dejagnu test harness.
libstdc++ Files for the dejagnu test harness.
data     Sample text files for testing input and output.
util     Files for libtestc++, utilities and testing routines.
```

Within a directory that includes test files, there may be additional subdirectories, or files. Originally, test cases were appended to one file that represented a particular section of the chapter under test, and was named accordingly. For instance, to test items related to 21.3.6.1 `-basic_string::find` [`lib.string::find`] in the standard, the following was used:

```
21_strings/find.cc
```

However, that practice soon became a liability as the test cases became huge and unwieldy, and testing new or extended functionality (like wide characters or named locales) became frustrating, leading to aggressive pruning of test cases on some platforms that covered up implementation errors. Now, the test suite has a policy of one file, one test case, which solves the above issues and gives finer grained results and more manageable error debugging. As an example, the test case quoted above becomes:

```
21_strings/basic_string/find/char/1.cc
21_strings/basic_string/find/char/2.cc
21_strings/basic_string/find/char/3.cc
21_strings/basic_string/find/wchar_t/1.cc
21_strings/basic_string/find/wchar_t/2.cc
21_strings/basic_string/find/wchar_t/3.cc
```

All new tests should be written with the policy of one test case, one file in mind.

B.4.1.2 Naming Conventions

In addition, there are some special names and suffixes that are used within the testsuite to designate particular kinds of tests.

- *_xin.cc*

This test case expects some kind of interactive input in order to finish or pass. At the moment, the interactive tests are not run by default. Instead, they are run by hand, like:

```
g++ 27_io/objects/char/3_xin.cc
cat 27_io/objects/char/3_xin.in | a.out
```

- *.in*

This file contains the expected input for the corresponding *_xin.cc* test case.

- *_neg.cc*

This test case is expected to fail: it's a negative test. At the moment, these are almost always compile time errors.

- *char*

This can either be a directory name or part of a longer file name, and indicates that this file, or the files within this directory are testing the `char` instantiation of a template.

- *wchar_t*

This can either be a directory name or part of a longer file name, and indicates that this file, or the files within this directory are testing the `wchar_t` instantiation of a template. Some hosts do not support `wchar_t` functionality, so for these targets, all of these tests will not be run.

- *thread*

This can either be a directory name or part of a longer file name, and indicates that this file, or the files within this directory are testing situations where multiple threads are being used.

- *performance*

This can either be an enclosing directory name or part of a specific file name. This indicates a test that is used to analyze runtime performance, for performance regression testing, or for other optimization related analysis. At the moment, these test cases are not run by default.

B.4.2 Running the Testsuite

B.4.2.1 Basic

You can check the status of the build without installing it using the dejagnu harness, much like the rest of the gcc tools.

```
make check
```

in the *libbuild* directory.

or

```
make check-target-libstdc++-v3
```

in the *gccbuild* directory.

These commands are functionally equivalent and will create a 'testsuite' directory underneath *libbuild* containing the results of the tests. Two results files will be generated: *libstdc++.sum*, which is a PASS/FAIL summary for each test, and *libstdc++.log* which is a log of the exact command line passed to the compiler, the compiler output, and the executable output (if any).

Archives of test results for various versions and platforms are available on the GCC website in the [build status](#) section of each individual release, and are also archived on a daily basis on the [gcc-testresults](#) mailing list. Please check either of these places for a similar combination of source version, operating system, and host CPU.

B.4.2.2 Variations

There are several options for running tests, including testing the regression tests, testing a subset of the regression tests, testing the performance tests, testing just compilation, testing installed tools, etc. In addition, there is a special rule for checking the exported symbols of the shared library.

To debug the dejagnu test harness during runs, try invoking with a specific argument to the variable RUNTESTFLAGS, as below.

```
make check-target-libstdc++-v3 RUNTESTFLAGS="-v"
```

or

```
make check-target-libstdc++-v3 RUNTESTFLAGS="-v -v"
```

To run a subset of the library tests, you will need to generate the *testsuite_files* file by running **make testsuite_files** in the *libbuild/testsuite* directory, described below. Edit the file to remove the tests you don't want and then run the testsuite as normal.

There are two ways to run on a simulator: set up DEJAGNU to point to a specially crafted site.exp, or pass down `--target_board` flags.

Example flags to pass down for various embedded builds are as follows:

```
--target=powerpc-eabism (libgloss/sim)
make check-target-libstdc++-v3 RUNTESTFLAGS="--target_board=powerpc-sim"

--target=calmrisc32 (libgloss/sid)
make check-target-libstdc++-v3 RUNTESTFLAGS="--target_board=calmrisc32-sid"

--target=xscale-elf (newlib/sim)
make check-target-libstdc++-v3 RUNTESTFLAGS="--target_board=arm-sim"
```

Also, here is an example of how to run the libstdc++ testsuite for a multilibed build directory with different ABI settings:

```
make check-target-libstdc++-v3 RUNTESTFLAGS='--target_board `unix{-mabi=32,, -mabi=64}`'
```

You can run the tests with a compiler and library that have already been installed. Make sure that the compiler (e.g., `g++`) is in your `PATH`. If you are using shared libraries, then you must also ensure that the directory containing the shared version of `libstdc++` is in your `LD_LIBRARY_PATH`, or equivalent. If your GCC source tree is at `/path/to/gcc`, then you can run the tests as follows:

```
runtest --tool libstdc++ --srcdir=/path/to/gcc/libstdc++-v3/testsuite
```

The testsuite will create a number of files in the directory in which you run this command. Some of those files might use the same name as files created by other testsuites (like the ones for GCC and G++), so you should not try to run all the testsuites in parallel from the same directory.

In addition, there are some testing options that are mostly of interest to library maintainers and system integrators. As such, these tests may not work on all CPU and host combinations, and may need to be executed in the `libbuilddir/testsuite` directory. These options include, but are not necessarily limited to, the following:

```
make testsuite_files
```

Five files are generated that determine what test files are run. These files are:

- *testsuite_files*
This is a list of all the test cases that will be run. Each test case is on a separate line, given with an absolute path from the `libsrcdir/testsuite` directory.
- *testsuite_files_interactive*
This is a list of all the interactive test cases, using the same format as the file list above. These tests are not run by default.
- *testsuite_files_performance*
This is a list of all the performance test cases, using the same format as the file list above. These tests are not run by default.
- *testsuite_thread*
This file indicates that the host system can run tests which involved multiple threads.
- *testsuite_wchar_t*
This file indicates that the host system can run the `wchar_t` tests, and corresponds to the macro definition `_GLIBCXX_USE_WCHAR_T` in the file `c++config.h`.

```
make check-abi
```

The library ABI can be tested. This involves testing the shared library against an ABI-defining previous version of symbol exports.

```
make check-compile
```

This rule compiles, but does not link or execute, the *testsuite_files* test cases and displays the output on stdout.

```
make check-performance
```

This rule runs through the *testsuite_files_performance* test cases and collects information for performance analysis and can be used to spot performance regressions. Various timing information is collected, as well as number of hard page faults, and memory used. This is not run by default, and the implementation is in flux.

We are interested in any strange failures of the testsuite; please email the main `libstdc++` mailing list if you see something odd or have questions.

B.4.2.3 Permutations

To run the libstdc++ test suite under the **debug mode**, edit `libstdc++-v3/scripts/testsuite_flags` to add the compile-time flag `-D_GLIBCXX_DEBUG` to the result printed by the `--build-cxx` option. Additionally, add the `-D_GLIBCXX_DEBUG_PEDANTIC` flag to turn on pedantic checking. The libstdc++ test suite should produce precisely the same results under debug mode that it does under release mode: any deviation indicates an error in either the library or the test suite.

The **parallel mode** can be tested in much the same manner, substituting `-D_GLIBCXX_PARALLEL` for `-D_GLIBCXX_DEBUG` in the previous paragraph.

Or, just run the testsuites with `CXXFLAGS` set to `-D_GLIBCXX_DEBUG` or `-D_GLIBCXX_PARALLEL`.

B.4.3 Writing a new test case

The first step in making a new test case is to choose the correct directory and file name, given the organization as previously described.

All files are copyright the FSF, and GPL'd: this is very important. The first copyright year should correspond to the date the file was checked in to SVN.

As per the dejagnu instructions, always return 0 from main to indicate success.

A bunch of utility functions and classes have already been abstracted out into the testsuite utility library, `libtestc++`. To use this functionality, just include the appropriate header file: the library or specific object files will automatically be linked in as part of the testsuite run.

For a test that needs to take advantage of the dejagnu test harness, what follows below is a list of special keyword that harness uses. Basically, a test case contains dg-keywords (see `dg.exp`) indicating what to do and what kinds of behavior are to be expected. New test cases should be written with the new style DejaGnu framework in mind.

To ease transition, here is the list of dg-keyword documentation lifted from `dg.exp`.

```
# The currently supported options are:
#
# dg-prms-id N
# set prms_id to N
#
# dg-options "options ..." [{ target selector }]
# specify special options to pass to the tool (eg: compiler)
#
# dg-do do-what-keyword [{ target/xfail selector }]
# 'do-what-keyword' is tool specific and is passed unchanged to
# ${tool}-dg-test. An example is gcc where 'keyword' can be any of:
# preprocess|compile|assemble|link|run
# and will do one of: produce a .i, produce a .s, produce a .o,
# produce an a.out, or produce an a.out and run it (the default is
# compile).
#
# dg-error regexp comment [{ target/xfail selector } [{.|0|linenum}]]
# indicate an error message <regexp> is expected on this line
# (the test fails if it doesn't occur)
# Linenum=0 for general tool messages (eg: -V arg missing).
# "." means the current line.
#
# dg-warning regexp comment [{ target/xfail selector } [{.|0|linenum}]]
# indicate a warning message <regexp> is expected on this line
# (the test fails if it doesn't occur)
#
# dg-bogus regexp comment [{ target/xfail selector } [{.|0|linenum}]]
# indicate a bogus error message <regexp> use to occur here
# (the test fails if it does occur)
#
# dg-build regexp comment [{ target/xfail selector }]
```

```

# indicate the build use to fail for some reason
# (errors covered here include bad assembler generated, tool crashes,
# and link failures)
# (the test fails if it does occur)
#
# dg-excess-errors comment [{ target/xfail selector }]
# indicate excess errors are expected (any line)
# (this should only be used sparingly and temporarily)
#
# dg-output regexp [{ target selector }]
# indicate the expected output of the program is <regexp>
# (there may be multiple occurrences of this, they are concatenated)
#
# dg-final { tcl code }
# add some tcl code to be run at the end
# (there may be multiple occurrences of this, they are concatenated)
# (unbalanced braces must be \-escaped)
#
# "{ target selector }" is a list of expressions that determine whether the
# test succeeds or fails for a particular target, or in some cases whether the
# option applies for a particular target.  If the case of 'dg-do' it specifies
# whether the test case is even attempted on the specified target.
#
# The target selector is always optional.  The format is one of:
#
# { xfail *-*-* ... } - the test is expected to fail for the given targets
# { target *-*-* ... } - the option only applies to the given targets
#
# At least one target must be specified, use *-*-* for "all targets".
# At present it is not possible to specify both 'xfail' and 'target'.
# "native" may be used in place of "*-*-*".

Example 1: Testing compilation only
// { dg-do compile }

Example 2: Testing for expected warnings on line 36, which all targets fail
// { dg-warning "string literals" "" { xfail *-*-* } 36 }

Example 3: Testing for expected warnings on line 36
// { dg-warning "string literals" "" { target *-*-* } 36 }

Example 4: Testing for compilation errors on line 41
// { dg-do compile }
// { dg-error "no match for" "" { target *-*-* } 41 }

Example 5: Testing with special command line settings, or without the
use of pre-compiled headers, in particular the stdc++.h.gch file. Any
options here will override the DEFAULT_CXXFLAGS and PCH_CXXFLAGS set
up in the normal.exp file.
// { dg-options "-O0" { target *-*-* } }

```

More examples can be found in the `libstdc++-v3/testsuite/*/*.cc` files.

B.4.4 Test Harness and Utilities

B.4.4.1 Dejagnu Harness Details

Underlying details of testing for conformance and regressions are abstracted via the GNU Dejagnu package. This is similar to the rest of GCC.

This is information for those looking at making changes to the testsuite structure, and/or needing to trace dejagnu's actions with `--verbose`. This will not be useful to people who are "merely" adding new tests to the existing structure.

The first key point when working with dejagnu is the idea of a "tool". Files, directories, and functions are all implicitly used when they are named after the tool in use. Here, the tool will always be "libstdc++".

The `lib` subdir contains support routines. The `lib/libstdc++.exp` file ("support library") is loaded automatically, and must explicitly load the others. For example, files can be copied from the core compiler's support directory into `lib`.

Some routines in `lib/libstdc++.exp` are callbacks, some are our own. Callbacks must be prefixed with the name of the tool. To easily distinguish the others, by convention our own routines are named "v3-*".

The next key point when working with dejagnu is "test files". Any directory whose name starts with the tool name will be searched for test files. (We have only one.) In those directories, any `.exp` file is considered a test file, and will be run in turn. Our main test file is called `normal.exp`; it runs all the tests in `testsuite_files` using the callbacks loaded from the support library.

The `config` directory is searched for any particular "target board" information unique to this library. This is currently unused and sets only default variables.

B.4.4.2 Utilities

The testsuite directory also contains some files that implement functionality that is intended to make writing test cases easier, or to avoid duplication, or to provide error checking in a way that is consistent across platforms and test harnesses. A stand-alone executable, called `abi_check`, and a static library called `libtestc++` are constructed. Both of these items are not installed, and only used during testing.

These files include the following functionality:

- `testsuite_abi.h`, `testsuite_abi.cc`, `testsuite_abi_check.cc`

Creates the executable `abi_check`. Used to check correctness of symbol versioning, visibility of exported symbols, and compatibility on symbols in the shared library, for hosts that support this feature. More information can be found in the ABI documentation [here](#)

- `testsuite_allocator.h`, `testsuite_allocator.cc`

Contains specialized allocators that keep track of construction and destruction. Also, support for overriding global new and delete operators, including verification that new and delete are called during execution, and that allocation over `max_size` fails.

- `testsuite_character.h`

Contains `std::char_traits` and `std::codecvt` specializations for a user-defined POD.

- `testsuite_hooks.h`, `testsuite_hooks.cc`

A large number of utilities, including:

- `VERIFY`
- `set_memory_limits`
- `verify_demangle`
- `run_tests_wrapped_locale`
- `run_tests_wrapped_env`
- `try_named_locale`
- `try_mkfifo`
- `func_callback`
- `counter`
- `copy_tracker`
- `copy_constructor`
- `assignment_operator`

- destructor
- `pod_char`, `pod_int` and associated `char_traits` specializations
- *testsuite_io.h*
Error, exception, and constraint checking for `std::streambuf`, `std::basic_stringbuf`, `std::basic_filebuf`.
- *testsuite_iterators.h*
Wrappers for various iterators.
- *testsuite_performance.h*
A number of class abstractions for performance counters, and reporting functions including:
 - `time_counter`
 - `resource_counter`
 - `report_performance`

B.4.5 Special Topics

B.4.5.1 Qualifying Exception Safety Guarantees

B.4.5.1.1 Overview

Testing is composed of running a particular test sequence, and looking at what happens to the surrounding code when exceptions are thrown. Each test is composed of measuring initial state, executing a particular sequence of code under some instrumented conditions, measuring a final state, and then examining the differences between the two states.

Test sequences are composed of constructed code sequences that exercise a particular function or member function, and either confirm no exceptions were generated, or confirm the consistency/coherency of the test subject in the event of a thrown exception.

Random code paths can be constructed using the basic test sequences and instrumentation as above, only combined in a random or pseudo-random way.

To compute the code paths that throw, test instruments are used that throw on allocation events (`__gnu_cxx::throw_allocator_random` and `__gnu_cxx::throw_allocator_limit`) and copy, assignment, comparison, increment, swap, and various operators (`__gnu_cxx::throw_type_random` and `__gnu_cxx::throw_type_limit`). Looping through a given test sequence and conditionally throwing in all instrumented places. Then, when the test sequence completes without an exception being thrown, assume all potential error paths have been exercised in a sequential manner.

B.4.5.1.2 Existing tests

- Ad Hoc

For example, `testsuite/23_containers/list/modifiers/3.cc`.

- Policy Based Data Structures

For example, take the test functor `rand_reg_test` in `testsuite/ext/pb_ds/regression/tree_no_data_map_rand.cc`. This uses `container_rand_regression_test` in `testsuite/util/regression/rand/assoc/container_rand_regression_test.h`.

Which has several tests for container member functions, Includes control and test container objects. Configuration includes random seed, iterations, number of distinct values, and the probability that an exception will be thrown. Assumes instantiating container uses an extension allocator, `__gnu_cxx::throw_allocator_random`, as the allocator type.

- C++11 Container Requirements.

Coverage is currently limited to testing container requirements for exception safety, although `__gnu_cxx::throw_type` meets the additional type requirements for testing numeric data structures and instantiating algorithms.

Of particular interest is extending testing to algorithms and then to parallel algorithms. Also io and locales.

The test instrumentation should also be extended to add instrumentation to `iterator` and `const_iterator` types that throw conditionally on iterator operations.

B.4.5.1.3 C++11 Requirements Test Sequence Descriptions

- Basic

Basic consistency on exception propagation tests. For each container, an object of that container is constructed, a specific member function is exercised in a `try` block, and then any thrown exceptions lead to error checking in the appropriate `catch` block. The container's use of resources is compared to the container's use prior to the test block. Resource monitoring is limited to allocations made through the container's `allocator_type`, which should be sufficient for container data structures. Included in these tests are member functions are iterator and `const_iterator` operations, `pop_front`, `pop_back`, `push_front`, `push_back`, `insert`, `erase`, `swap`, `clear`, and `rehash`. The container in question is instantiated with two instrumented template arguments, with `__gnu_cxx::throw_allocator_limit` as the allocator type, and with `__gnu_cxx::throw_type_limit` as the value type. This allows the test to loop through conditional throw points.

The general form is demonstrated in `testsuite/23_containers/list/requirements/exception/basic.cc`. The instantiating test object is `__gnu_test::basic_safety` and is detailed in `testsuite/util/exception/safety.h`.

- Generation Prohibited

Exception generation tests. For each container, an object of that container is constructed and all member functions required to not throw exceptions are exercised. Included in these tests are member functions are iterator and `const_iterator` operations, `erase`, `pop_front`, `pop_back`, `swap`, and `clear`. The container in question is instantiated with two instrumented template arguments, with `__gnu_cxx::throw_allocator_random` as the allocator type, and with `__gnu_cxx::throw_type_random` as the value type. This test does not loop, an instead is sudden death: first error fails.

The general form is demonstrated in `testsuite/23_containers/list/requirements/exception/generation_prohibited.cc`. The instantiating test object is `__gnu_test::generation_prohibited` and is detailed in `testsuite/util/exception/safety.h`.

- Propagation Consistent

Container rollback on exception propagation tests. For each container, an object of that container is constructed, a specific member function that requires rollback to a previous known good state is exercised in a `try` block, and then any thrown exceptions lead to error checking in the appropriate `catch` block. The container is compared to the container's last known good state using such parameters as size, contents, and iterator references. Included in these tests are member functions are `push_front`, `push_back`, `insert`, and `rehash`. The container in question is instantiated with two instrumented template arguments, with `__gnu_cxx::throw_allocator_limit` as the allocator type, and with `__gnu_cxx::throw_type_limit` as the value type. This allows the test to loop through conditional throw points.

The general form demonstrated in `testsuite/23_containers/list/requirements/exception/propagation_coherent.cc`. The instantiating test object is `__gnu_test::propagation_coherent` and is detailed in `testsuite/util/exception/safety.h`.

B.5 ABI Policy and Guidelines

B.5.1 The C++ Interface

C++ applications often depend on specific language support routines, say for throwing exceptions, or catching exceptions, and perhaps also depend on features in the C++ Standard Library.

The C++ Standard Library has many include files, types defined in those include files, specific named functions, and other behavior. The text of these behaviors, as written in source include files, is called the Application Programming Interface, or API.

Furthermore, C++ source that is compiled into object files is transformed by the compiler: it arranges objects with specific alignment and in a particular layout, mangling names according to a well-defined algorithm, has specific arrangements for the support of virtual functions, etc. These details are defined as the compiler Application Binary Interface, or ABI. The GNU C++ compiler uses an industry-standard C++ ABI starting with version 3. Details can be found in the [ABI specification](#).

The GNU C++ compiler, `g++`, has a compiler command line option to switch between various different C++ ABIs. This explicit version switch is the flag `-fabi-version`. In addition, some `g++` command line options may change the ABI as a side-effect of use. Such flags include `-fpack-struct` and `-fno-exceptions`, but include others: see the complete list in the GCC manual under the heading [Options for Code Generation Conventions](#).

The configure options used when building a specific libstdc++ version may also impact the resulting library ABI. The available configure options, and their impact on the library ABI, are documented [here](#).

Putting all of these ideas together results in the C++ Standard library ABI, which is the compilation of a given library API by a given compiler ABI. In a nutshell:

“ library API + compiler ABI = library ABI ”

The library ABI is mostly of interest for end-users who have unresolved symbols and are linking dynamically to the C++ Standard library, and who thus must be careful to compile their application with a compiler that is compatible with the available C++ Standard library binary. In this case, compatible is defined with the equation above: given an application compiled with a given compiler ABI and library API, it will work correctly with a Standard C++ Library created with the same constraints.

To use a specific version of the C++ ABI, one must use a corresponding GNU C++ toolchain (i.e., g++ and libstdc++) that implements the C++ ABI in question.

B.5.2 Versioning

The C++ interface has evolved throughout the history of the GNU C++ toolchain. With each release, various details have been changed so as to give distinct versions to the C++ interface.

B.5.2.1 Goals

Extending existing, stable ABIs. Versioning gives subsequent releases of library binaries the ability to add new symbols and add functionality, all the while retaining compatibility with the previous releases in the series. Thus, program binaries linked with the initial release of a library binary will still run correctly if the library binary is replaced by carefully-managed subsequent library binaries. This is called forward compatibility.

The reverse (backwards compatibility) is not true. It is not possible to take program binaries linked with the latest version of a library binary in a release series (with additional symbols added), substitute in the initial release of the library binary, and remain link compatible.

Allows multiple, incompatible ABIs to coexist at the same time.

B.5.2.2 History

How can this complexity be managed? What does C++ versioning mean? Because library and compiler changes often make binaries compiled with one version of the GNU tools incompatible with binaries compiled with other (either newer or older) versions of the same GNU tools, specific techniques are used to make managing this complexity easier.

The following techniques are used:

1. Release versioning on the libgcc_s.so binary.

This is implemented via file names and the ELF DT_SONAME mechanism (at least on ELF systems). It is versioned as follows:

- GCC 3.x: libgcc_s.so.1
- GCC 4.x: libgcc_s.so.1

For m68k-linux the versions differ as follows:

- GCC 3.4, GCC 4.x: libgcc_s.so.1 when configuring `--with-sjlj-exceptions`, or libgcc_s.so.2

For hppa-linux the versions differ as follows:

- GCC 3.4, GCC 4.[0-1]: either libgcc_s.so.1 when configuring `--with-sjlj-exceptions`, or libgcc_s.so.2
- GCC 4.[2-7]: either libgcc_s.so.3 when configuring `--with-sjlj-exceptions`) or libgcc_s.so.4

2. Symbol versioning on the `libgcc_s.so` binary.

It is versioned with the following labels and version definitions, where the version definition is the maximum for a particular release. Labels are cumulative. If a particular release is not listed, it has the same version labels as the preceding release.

This corresponds to the mapfile: `gcc/libgcc-std.ver`

- GCC 3.0.0: `GCC_3.0`
- GCC 3.3.0: `GCC_3.3`
- GCC 3.3.1: `GCC_3.3.1`
- GCC 3.3.2: `GCC_3.3.2`
- GCC 3.3.4: `GCC_3.3.4`
- GCC 3.4.0: `GCC_3.4`
- GCC 3.4.2: `GCC_3.4.2`
- GCC 3.4.4: `GCC_3.4.4`
- GCC 4.0.0: `GCC_4.0.0`
- GCC 4.1.0: `GCC_4.1.0`
- GCC 4.2.0: `GCC_4.2.0`
- GCC 4.3.0: `GCC_4.3.0`
- GCC 4.4.0: `GCC_4.4.0`
- GCC 4.5.0: `GCC_4.5.0`
- GCC 4.6.0: `GCC_4.6.0`
- GCC 4.7.0: `GCC_4.7.0`
- GCC 4.8.0: `GCC_4.8.0`

3. Release versioning on the `libstdc++.so` binary, implemented in the same way as the `libgcc_s.so` binary above. Listed is the filename: `DT_SONAME` can be deduced from the filename by removing the last two period-delimited numbers. For example, filename `libstdc++.so.5.0.4` corresponds to a `DT_SONAME` of `libstdc++.so.5`. Binaries with equivalent `DT_SONAMES` are forward-compatible: in the table below, releases incompatible with the previous one are explicitly noted. If a particular release is not listed, its `libstdc++.so` binary has the same filename and `DT_SONAME` as the preceding release.

It is versioned as follows:

- GCC 3.0.0: `libstdc++.so.3.0.0`
- GCC 3.0.1: `libstdc++.so.3.0.1`
- GCC 3.0.2: `libstdc++.so.3.0.2`
- GCC 3.0.3: `libstdc++.so.3.0.2` (See Note 1)
- GCC 3.0.4: `libstdc++.so.3.0.4`
- GCC 3.1.0: `libstdc++.so.4.0.0` (*Incompatible with previous*)
- GCC 3.1.1: `libstdc++.so.4.0.1`
- GCC 3.2.0: `libstdc++.so.5.0.0` (*Incompatible with previous*)
- GCC 3.2.1: `libstdc++.so.5.0.1`
- GCC 3.2.2: `libstdc++.so.5.0.2`
- GCC 3.2.3: `libstdc++.so.5.0.3` (See Note 2)
- GCC 3.3.0: `libstdc++.so.5.0.4`
- GCC 3.3.1: `libstdc++.so.5.0.5`
- GCC 3.4.0: `libstdc++.so.6.0.0` (*Incompatible with previous*)
- GCC 3.4.1: `libstdc++.so.6.0.1`
- GCC 3.4.2: `libstdc++.so.6.0.2`

- GCC 3.4.3: libstdc++.so.6.0.3
- GCC 4.0.0: libstdc++.so.6.0.4
- GCC 4.0.1: libstdc++.so.6.0.5
- GCC 4.0.2: libstdc++.so.6.0.6
- GCC 4.0.3: libstdc++.so.6.0.7
- GCC 4.1.0: libstdc++.so.6.0.7
- GCC 4.1.1: libstdc++.so.6.0.8
- GCC 4.2.0: libstdc++.so.6.0.9
- GCC 4.2.1: libstdc++.so.6.0.9 (See Note 3)
- GCC 4.2.2: libstdc++.so.6.0.9
- GCC 4.3.0: libstdc++.so.6.0.10
- GCC 4.4.0: libstdc++.so.6.0.11
- GCC 4.4.1: libstdc++.so.6.0.12
- GCC 4.4.2: libstdc++.so.6.0.13
- GCC 4.5.0: libstdc++.so.6.0.14
- GCC 4.6.0: libstdc++.so.6.0.15
- GCC 4.6.1: libstdc++.so.6.0.16
- GCC 4.7.0: libstdc++.so.6.0.17
- GCC 4.8.0: libstdc++.so.6.0.18
- GCC 4.8.3: libstdc++.so.6.0.19
- GCC 4.9.0: libstdc++.so.6.0.20

Note 1: Error should be libstdc++.so.3.0.3.

Note 2: Not strictly required.

Note 3: This release (but not previous or subsequent) has one known incompatibility, see [33678](#) in the GCC bug database.

4. Symbol versioning on the libstdc++.so binary.

mapfile: libstdc++-v3/config/abi/pre/gnu.ver

It is versioned with the following labels and version definitions, where the version definition is the maximum for a particular release. Note, only symbols which are newly introduced will use the maximum version definition. Thus, for release series with the same label, but incremented version definitions, the later release has both versions. (An example of this would be the GCC 3.2.1 release, which has GLIBCPP_3.2.1 for new symbols and GLIBCPP_3.2 for symbols that were introduced in the GCC 3.2.0 release.) If a particular release is not listed, it has the same version labels as the preceding release.

- GCC 3.0.0: (Error, not versioned)
- GCC 3.0.1: (Error, not versioned)
- GCC 3.0.2: (Error, not versioned)
- GCC 3.0.3: (Error, not versioned)
- GCC 3.0.4: (Error, not versioned)
- GCC 3.1.0: GLIBCPP_3.1, CXXABI_1
- GCC 3.1.1: GLIBCPP_3.1, CXXABI_1
- GCC 3.2.0: GLIBCPP_3.2, CXXABI_1.2
- GCC 3.2.1: GLIBCPP_3.2.1, CXXABI_1.2
- GCC 3.2.2: GLIBCPP_3.2.2, CXXABI_1.2
- GCC 3.2.3: GLIBCPP_3.2.2, CXXABI_1.2
- GCC 3.3.0: GLIBCPP_3.2.2, CXXABI_1.2.1

- GCC 3.3.1: GLIBCPP_3.2.3, CXXABI_1.2.1
- GCC 3.3.2: GLIBCPP_3.2.3, CXXABI_1.2.1
- GCC 3.3.3: GLIBCPP_3.2.3, CXXABI_1.2.1
- GCC 3.4.0: GLIBCXX_3.4, CXXABI_1.3
- GCC 3.4.1: GLIBCXX_3.4.1, CXXABI_1.3
- GCC 3.4.2: GLIBCXX_3.4.2
- GCC 3.4.3: GLIBCXX_3.4.3
- GCC 4.0.0: GLIBCXX_3.4.4, CXXABI_1.3.1
- GCC 4.0.1: GLIBCXX_3.4.5
- GCC 4.0.2: GLIBCXX_3.4.6
- GCC 4.0.3: GLIBCXX_3.4.7
- GCC 4.1.1: GLIBCXX_3.4.8
- GCC 4.2.0: GLIBCXX_3.4.9
- GCC 4.3.0: GLIBCXX_3.4.10, CXXABI_1.3.2
- GCC 4.4.0: GLIBCXX_3.4.11, CXXABI_1.3.3
- GCC 4.4.1: GLIBCXX_3.4.12, CXXABI_1.3.3
- GCC 4.4.2: GLIBCXX_3.4.13, CXXABI_1.3.3
- GCC 4.5.0: GLIBCXX_3.4.14, CXXABI_1.3.4
- GCC 4.6.0: GLIBCXX_3.4.15, CXXABI_1.3.5
- GCC 4.6.1: GLIBCXX_3.4.16, CXXABI_1.3.5
- GCC 4.7.0: GLIBCXX_3.4.17, CXXABI_1.3.6
- GCC 4.8.0: GLIBCXX_3.4.18, CXXABI_1.3.7
- GCC 4.8.3: GLIBCXX_3.4.19, CXXABI_1.3.7
- GCC 4.9.0: GLIBCXX_3.4.20, CXXABI_1.3.8

5. Incremental bumping of a compiler pre-defined macro, `__GXX_ABI_VERSION`. This macro is defined as the version of the compiler v3 ABI, with g++ 3.0 being version 100. This macro will be automatically defined whenever g++ is used (the curious can test this by invoking g++ with the '-v' flag.)

This macro was defined in the file "lang-specs.h" in the gcc/cp directory. Later versions defined it in "c-common.c" in the gcc directory, and from G++ 3.4 it is defined in c-cppbuiltin.c and its value determined by the '-fabi-version' command line option.

It is versioned as follows, where 'n' is given by '-fabi-version=n':

- GCC 3.0: 100
- GCC 3.1: 100 (Error, should be 101)
- GCC 3.2: 102
- GCC 3.3: 102
- GCC 3.4, GCC 4.x: 102 (when n=1)
- GCC 3.4, GCC 4.x: 1000 + n (when n>1)
- GCC 3.4, GCC 4.x: 999999 (when n=0)

6. Changes to the default compiler option for `-fabi-version`.

It is versioned as follows:

- GCC 3.0: (Error, not versioned)
- GCC 3.1: (Error, not versioned)
- GCC 3.2: `-fabi-version=1`

- GCC 3.3: `-fabi-version=1`
- GCC 3.4, GCC 4.x: `-fabi-version=2` (*Incompatible with previous*)

7. Incremental bumping of a library pre-defined macro. For releases before 3.4.0, the macro is `__GLIBCPP__`. For later releases, it's `__GLIBCXX__`. (The `libstdc++` project generously changed from `CPP` to `CXX` throughout its source to allow the "C" pre-processor the `CPP` macro namespace.) These macros are defined as the date the library was released, in compressed ISO date format, as an unsigned long.

This macro is defined in the file `"c++config"` in the `"libstdc++-v3/include/bits"` directory. (Up to GCC 4.1.0, it was changed every night by an automated script. Since GCC 4.1.0, it is the same value as `gcc/DATESTAMP`.)

It is versioned as follows:

- GCC 3.0.0: 20010615
 - GCC 3.0.1: 20010819
 - GCC 3.0.2: 20011023
 - GCC 3.0.3: 20011220
 - GCC 3.0.4: 20020220
 - GCC 3.1.0: 20020514
 - GCC 3.1.1: 20020725
 - GCC 3.2.0: 20020814
 - GCC 3.2.1: 20021119
 - GCC 3.2.2: 20030205
 - GCC 3.2.3: 20030422
 - GCC 3.3.0: 20030513
 - GCC 3.3.1: 20030804
 - GCC 3.3.2: 20031016
 - GCC 3.3.3: 20040214
 - GCC 3.4.0: 20040419
 - GCC 3.4.1: 20040701
 - GCC 3.4.2: 20040906
 - GCC 3.4.3: 20041105
 - GCC 3.4.4: 20050519
 - GCC 3.4.5: 20051201
 - GCC 3.4.6: 20060306
 - GCC 4.0.0: 20050421
 - GCC 4.0.1: 20050707
 - GCC 4.0.2: 20050921
 - GCC 4.0.3: 20060309
 - GCC 4.1.0: 20060228
 - GCC 4.1.1: 20060524
 - GCC 4.1.2: 20070214
 - GCC 4.2.0: 20070514
 - GCC 4.2.1: 20070719
 - GCC 4.2.2: 20071007
 - GCC 4.2.3: 20080201
 - GCC 4.2.4: 20080519
 - GCC 4.3.0: 20080306
-

- GCC 4.3.1: 20080606
- GCC 4.3.2: 20080827
- GCC 4.3.3: 20090124
- GCC 4.3.4: 20090804
- GCC 4.3.5: 20100522
- GCC 4.3.6: 20110627
- GCC 4.4.0: 20090421
- GCC 4.4.1: 20090722
- GCC 4.4.2: 20091015
- GCC 4.4.3: 20100121
- GCC 4.4.4: 20100429
- GCC 4.4.5: 20101001
- GCC 4.4.6: 20110416
- GCC 4.4.7: 20120313
- GCC 4.5.0: 20100414
- GCC 4.5.1: 20100731
- GCC 4.5.2: 20101216
- GCC 4.5.3: 20110428
- GCC 4.5.4: 20120702
- GCC 4.6.0: 20110325
- GCC 4.6.1: 20110627
- GCC 4.6.2: 20111026
- GCC 4.6.3: 20120301
- GCC 4.7.0: 20120322
- GCC 4.7.1: 20120614
- GCC 4.7.2: 20120920

8. Incremental bumping of a library pre-defined macro, `_GLIBCPP_VERSION`. This macro is defined as the released version of the library, as a string literal. This is only implemented in GCC 3.1.0 releases and higher, and is deprecated in 3.4 (where it is called `_GLIBCXX_VERSION`).

This macro is defined in the file "c++config" in the "libstdc++-v3/include/bits" directory and is generated automatically by autoconf as part of the configure-time generation of config.h.

It is versioned as follows:

- GCC 3.0.0: "3.0.0"
 - GCC 3.0.1: "3.0.0" (Error, should be "3.0.1")
 - GCC 3.0.2: "3.0.0" (Error, should be "3.0.2")
 - GCC 3.0.3: "3.0.0" (Error, should be "3.0.3")
 - GCC 3.0.4: "3.0.0" (Error, should be "3.0.4")
 - GCC 3.1.0: "3.1.0"
 - GCC 3.1.1: "3.1.1"
 - GCC 3.2.0: "3.2"
 - GCC 3.2.1: "3.2.1"
 - GCC 3.2.2: "3.2.2"
 - GCC 3.2.3: "3.2.3"
-

- GCC 3.3.0: "3.3"
- GCC 3.3.1: "3.3.1"
- GCC 3.3.2: "3.3.2"
- GCC 3.3.3: "3.3.3"
- GCC 3.4: "version-unused"
- GCC 4.x: "version-unused"

9. Matching each specific C++ compiler release to a specific set of C++ include files. This is only implemented in GCC 3.1.1 releases and higher.

All C++ includes are installed in `include/c++`, then nest in a directory hierarchy corresponding to the C++ compiler's released version. This version corresponds to the variable `"gcc_version"` in `"libstdc++-v3/acinclude.m4"`, and more details can be found in that file's macro `GLIBCXX_CONFIGURE` (`GLIBCPP_CONFIGURE` before GCC 3.4.0).

C++ includes are versioned as follows:

- GCC 3.0.0: `include/g++-v3`
- GCC 3.0.1: `include/g++-v3`
- GCC 3.0.2: `include/g++-v3`
- GCC 3.0.3: `include/g++-v3`
- GCC 3.0.4: `include/g++-v3`
- GCC 3.1.0: `include/g++-v3`
- GCC 3.1.1: `include/c++/3.1.1`
- GCC 3.2.0: `include/c++/3.2`
- GCC 3.2.1: `include/c++/3.2.1`
- GCC 3.2.2: `include/c++/3.2.2`
- GCC 3.2.3: `include/c++/3.2.3`
- GCC 3.3.0: `include/c++/3.3`
- GCC 3.3.1: `include/c++/3.3.1`
- GCC 3.3.2: `include/c++/3.3.2`
- GCC 3.3.3: `include/c++/3.3.3`
- GCC 3.4.x: `include/c++/3.4.x`
- GCC 4.x.y: `include/c++/4.x.y`

Taken together, these techniques can accurately specify interface and implementation changes in the GNU C++ tools themselves. Used properly, they allow both the GNU C++ tools implementation, and programs using them, an evolving yet controlled development that maintains backward compatibility.

B.5.2.3 Prerequisites

Minimum environment that supports a versioned ABI: A supported dynamic linker, a GNU linker of sufficient vintage to understand demangled C++ name globbing (`ld`) or the Sun linker, a shared executable compiled with `g++`, and shared libraries (`libgcc_s`, `libstdc++`) compiled by a compiler (`g++`) with a compatible ABI. Phew.

On top of all that, an additional constraint: `libstdc++` did not attempt to version symbols (or age gracefully, really) until version 3.1.0.

Most modern GNU/Linux and BSD versions, particularly ones using GCC 3.1 and later, will meet the requirements above, as does Solaris 2.5 and up.

B.5.2.4 Configuring

It turns out that most of the configure options that change default behavior will impact the mangled names of exported symbols, and thus impact versioning and compatibility.

For more information on configure options, including ABI impacts, see: [here](#)

There is one flag that explicitly deals with symbol versioning: `--enable-symvers`.

In particular, `libstdc++-v3/acinclude.m4` has a macro called `GLIBCXX_ENABLE_SYMVERS` that defaults to yes (or the argument passed in via `--enable-symvers=foo`). At that point, the macro attempts to make sure that all the requirements for symbol versioning are in place. For more information, please consult `acinclude.m4`.

B.5.2.5 Checking Active

When the GNU C++ library is being built with symbol versioning on, you should see the following at configure time for `libstdc++`:

```
checking versioning on shared library symbols... gnu
```

or another of the supported styles. If you don't see this line in the configure output, or if this line appears but the last word is 'no', then you are out of luck.

If the compiler is pre-installed, a quick way to test is to compile the following (or any) simple C++ file and link it to the shared `libstdc++` library:

```
#include <iostream>

int main()
{ std::cout << "hello" << std::endl; return 0; }

%g++ hello.cc -o hello.out

%ldd hello.out
libstdc++.so.5 => /usr/lib/libstdc++.so.5 (0x00764000)
libm.so.6 => /lib/tls/libm.so.6 (0x004a8000)
libgcc_s.so.1 => /mnt/hd/bld/gcc/gcc/libgcc_s.so.1 (0x40016000)
libc.so.6 => /lib/tls/libc.so.6 (0x0036d000)
/lib/ld-linux.so.2 => /lib/ld-linux.so.2 (0x00355000)

%nm hello.out
```

If you see symbols in the resulting output with "GLIBCXX_3" as part of the name, then the executable is versioned. Here's an example:

```
U _ZNSt8ios_base4InitC1Ev@@GLIBCXX_3.4
```

On Solaris 2, you can use `pvs -r` instead:

```
%g++ hello.cc -o hello.out

%pvs -r hello.out
libstdc++.so.6 (GLIBCXX_3.4, GLIBCXX_3.4.12);
libgcc_s.so.1 (GCC_3.0);
libc.so.1 (SUNWprivate_1.1, SYSVABI_1.3);
```

`ldd -v` works too, but is very verbose.

B.5.3 Allowed Changes

The following will cause the library minor version number to increase, say from "libstdc++.so.3.0.4" to "libstdc++.so.3.0.5".

1. Adding an exported global or static data member
2. Adding an exported function, static or non-virtual member function
3. Adding an exported symbol or symbols by additional instantiations

Other allowed changes are possible.

B.5.4 Prohibited Changes

The following non-exhaustive list will cause the library major version number to increase, say from "libstdc++.so.3.0.4" to "libstdc++.so.4.0.0".

1. Changes in the gcc/g++ compiler ABI
2. Changing size of an exported symbol
3. Changing alignment of an exported symbol
4. Changing the layout of an exported symbol
5. Changing mangling on an exported symbol
6. Deleting an exported symbol
7. Changing the inheritance properties of a type by adding or removing base classes
8. Changing the size, alignment, or layout of types specified in the C++ standard. These may not necessarily be instantiated or otherwise exported in the library binary, and include all the required locale facets, as well as things like `std::basic_streambuf`, et al.
9. Adding an explicit copy constructor or destructor to a class that would otherwise have implicit versions. This will change the way the compiler deals with this class in by-value return statements or parameters: instead of passing instances of this class in registers, the compiler will be forced to use memory. See the section on [Function Calling Conventions and APIs](#) of the C++ ABI documentation for further details.

B.5.5 Implementation

1. Separation of interface and implementation

This is accomplished by two techniques that separate the API from the ABI: forcing undefined references to link against a library binary for definitions.

Include files have declarations, source files have defines For non-templated types, such as much of `class locale`, the appropriate standard C++ include, say `locale`, can contain full declarations, while various source files (say `locale.cc`, `locale_init.cc`, `localename.cc`) contain definitions.

Extern template on required types For parts of the standard that have an explicit list of required instantiations, the GNU extension syntax `extern template` can be used to control where template definitions reside. By marking required instantiations as `extern template` in include files, and providing explicit instantiations in the appropriate instantiation files, non-inlined template functions can be versioned. This technique is mostly used on parts of the standard that require `char` and `wchar_t` instantiations, and includes `basic_string`, the locale facets, and the types in `iostreams`.

In addition, these techniques have the additional benefit that they reduce binary size, which can increase runtime performance.

2. Namespaces linking symbol definitions to export mapfiles

All symbols in the shared library binary are processed by a linker script at build time that either allows or disallows external linkage. Because of this, some symbols, regardless of normal C/C++ linkage, are not visible. Symbols that are internal have several appealing characteristics: by not exporting the symbols, there are no relocations when the shared library is started and thus this makes for faster runtime loading performance by the underlying dynamic loading mechanism. In addition, they have the possibility of changing without impacting ABI compatibility.

The following namespaces are transformed by the mapfile:

namespace std Defaults to exporting all symbols in label `GLIBCXX` that do not begin with an underscore, i.e., `__test_func` would not be exported by default. Select exceptional symbols are allowed to be visible.

namespace __gnu_cxx Defaults to not exporting any symbols in label `GLIBCXX`, select items are allowed to be visible.

namespace __gnu_internal Defaults to not exported, no items are allowed to be visible.

namespace __cxxabi1, aliased to namespace abi Defaults to not exporting any symbols in label `CXXABI`, select items are allowed to be visible.

3. Freezing the API

Disallowed changes, as above, are not made on a stable release branch. Enforcement tends to be less strict with GNU extensions that standard includes.

B.5.6 Testing

B.5.6.1 Single ABI Testing

Testing for GNU C++ ABI changes is composed of two distinct areas: testing the C++ compiler (g++) for compiler changes, and testing the C++ library (libstdc++) for library changes.

Testing the C++ compiler ABI can be done various ways.

One. Intel ABI checker.

Two. The second is yet unreleased, but has been announced on the gcc mailing list. It is yet unspecified if these tools will be freely available, and able to be included in a GNU project. Please contact Mark Mitchell (mark@codesourcery.com) for more details, and current status.

Three. Involves using the vlad.consistency test framework. This has also been discussed on the gcc mailing lists.

Testing the C++ library ABI can also be done various ways.

One. (Brendan Kehoe, Jeff Law suggestion to run 'make check-c++' two ways, one with a new compiler and an old library, and the other with an old compiler and a new library, and look for testsuite regressions)

Details on how to set this kind of test up can be found here: <http://gcc.gnu.org/ml/gcc/2002-08/msg00142.html>

Two. Use the 'make check-abi' rule in the libstdc++ Makefile.

This is a proactive check of the library ABI. Currently, exported symbol names that are either weak or defined are checked against a last known good baseline. Currently, this baseline is keyed off of 3.4.0 binaries, as this was the last time the .so number was incremented. In addition, all exported names are demangled, and the exported objects are checked to make sure they are the same size as the same object in the baseline. Notice that each baseline is relative to a *default* configured library and compiler: in particular, if options such as `--enable-clocale`, or `--with-cpu`, in case of multilibs, are used at configure time, the check may fail, either because of substantive differences or because of limitations of the current checking machinery.

This dataset is insufficient, yet a start. Also needed is a comprehensive check for all user-visible types part of the standard library for `sizeof()` and `alignof()` changes.

Verifying compatible layouts of objects is not even attempted. It should be possible to use `sizeof`, `alignof`, and `offsetof` to compute offsets for each structure and type in the standard library, saving to another datafile. Then, compute this in a similar way for new binaries, and look for differences.

Another approach might be to use the `-fdump-class-hierarchy` flag to get information. However, currently this approach gives insufficient data for use in library testing, as class data members, their offsets, and other detailed data is not displayed with this flag. (See PR [g++/7470](#) on how this was used to find bugs.)

Perhaps there are other C++ ABI checkers. If so, please notify us. We'd like to know about them!

B.5.6.2 Multiple ABI Testing

A "C" application, dynamically linked to two shared libraries, `liba`, `libb`. The dependent library `liba` is a C++ shared library compiled with GCC 3.3, and uses `io`, `exceptions`, `locale`, etc. The dependent library `libb` is a C++ shared library compiled with GCC 3.4, and also uses `io`, `exceptions`, `locale`, etc.

As above, `libone` is constructed as follows:

```
%$bld/H-x86-gcc-3.4.0/bin/g++ -fPIC -DPIC -c a.cc

%$bld/H-x86-gcc-3.4.0/bin/g++ -shared -Wl,-soname -Wl,libone.so.1 -Wl,-O1 -Wl,-z,defs a.o - ←
    o libone.so.1.0.0

%ln -s libone.so.1.0.0 libone.so

%$bld/H-x86-gcc-3.4.0/bin/g++ -c a.cc

%ar cru libone.a a.o
```

And, `libtwo` is constructed as follows:

```
%$bld/H-x86-gcc-3.3.3/bin/g++ -fPIC -DPIC -c b.cc

%$bld/H-x86-gcc-3.3.3/bin/g++ -shared -Wl,-soname -Wl,libtwo.so.1 -Wl,-O1 -Wl,-z,defs b.o - ←
    o libtwo.so.1.0.0

%ln -s libtwo.so.1.0.0 libtwo.so

%$bld/H-x86-gcc-3.3.3/bin/g++ -c b.cc

%ar cru libtwo.a b.o
```

...with the resulting libraries looking like

```
%ldd libone.so.1.0.0
    libstdc++.so.6 => /usr/lib/libstdc++.so.6 (0x40016000)
    libm.so.6 => /lib/tls/libm.so.6 (0x400fa000)
    libgcc_s.so.1 => /mnt/hd/bld/gcc/gcc/libgcc_s.so.1 (0x4011c000)
    libc.so.6 => /lib/tls/libc.so.6 (0x40125000)
    /lib/ld-linux.so.2 => /lib/ld-linux.so.2 (0x00355000)

%ldd libtwo.so.1.0.0
    libstdc++.so.5 => /usr/lib/libstdc++.so.5 (0x40027000)
    libm.so.6 => /lib/tls/libm.so.6 (0x400e1000)
    libgcc_s.so.1 => /mnt/hd/bld/gcc/gcc/libgcc_s.so.1 (0x40103000)
    libc.so.6 => /lib/tls/libc.so.6 (0x4010c000)
    /lib/ld-linux.so.2 => /lib/ld-linux.so.2 (0x00355000)
```

Then, the "C" compiler is used to compile a source file that uses functions from each library.

```
gcc test.c -g -O2 -L. -lone -ltwo /usr/lib/libstdc++.so.5 /usr/lib/libstdc++.so.6
```

Which gives the expected:

```
%ldd a.out
    libstdc++.so.5 => /usr/lib/libstdc++.so.5 (0x00764000)
    libstdc++.so.6 => /usr/lib/libstdc++.so.6 (0x40015000)
    libc.so.6 => /lib/tls/libc.so.6 (0x0036d000)
    libm.so.6 => /lib/tls/libm.so.6 (0x004a8000)
```

```
libgcc_s.so.1 => /mnt/hd/bld/gcc/gcc/libgcc_s.so.1 (0x400e5000)
/lib/ld-linux.so.2 => /lib/ld-linux.so.2 (0x00355000)
```

This resulting binary, when executed, will be able to safely use code from both `liba`, and the dependent `libstdc++.so.6`, and `libb`, with the dependent `libstdc++.so.5`.

B.5.7 Outstanding Issues

Some features in the C++ language make versioning especially difficult. In particular, compiler generated constructs such as implicit instantiations for templates, typeid information, and virtual tables all may cause ABI leakage across shared library boundaries. Because of this, mixing C++ ABIs is not recommended at this time.

For more background on this issue, see these bugzilla entries:

[24660: versioning weak symbols in libstdc++](#)

[19664: libstdc++ headers should have pop/push of the visibility around the declarations](#)

B.5.8 Bibliography

- [99] [ABIcheck](#)
- [100] [C++ ABI Summary](#)
- [101] [Intel Compilers for Linux Compatibility with the GNU Compilers](#)
- [102] [Linker and Libraries Guide \(document 819-0690\)](#)
- [103] [Sun Studio 11: C++ Migration Guide \(document 819-3689\)](#)
- [104] Ulrich Drepper, [How to Write Shared Libraries](#)
- [105] [C++ ABI for the ARM Architecture](#)
- [106] Benjamin Kosnik, [Dynamic Shared Objects: Survey and Issues](#) , ISO C++ J16/06-0046 .
- [107] Benjamin Kosnik, [Versioning With Namespaces](#) , ISO C++ J16/06-0083 .
- [108] Pavel ShvedDenis Silakov, [Binary Compatibility of Shared Libraries Implemented in C++ on GNU/Linux Systems](#) , SYRCoSE 2009 .

B.6 API Evolution and Deprecation History

A list of user-visible changes, in chronological order

B.6.1 3.0

Extensions moved to `include/ext`.

Include files from the SGI/HP sources that pre-date the ISO standard are added. These files are placed into the `include/backward` directory and a deprecated warning is added that notifies on inclusion (`-Wno-deprecated` deactivates the warning.)

Deprecated include `backward/strstream` added.

Removal of include `builtinbuf.h`, `indstream.h`, `parsestream.h`, `PlotFile.h`, `SFile.h`, `stdiostream.h`, and `stream.h`.

B.6.2 3.1

Extensions from SGI/HP moved from namespace `std` to namespace `__gnu_cxx`. As part of this, the following new includes are added: `ext/algorithm`, `ext/functional`, `ext/iterator`, `ext/memory`, and `ext/numeric`.

Extensions to `basic_filebuf` introduced: `__gnu_cxx::enc_filebuf`, and `__gnu_cxx::stdio_filebuf`.

Extensions to tree data structures added in `ext/rb_tree`.

Removal of `ext/tree`, moved to `backward/tree.h`.

B.6.3 3.2

Symbol versioning introduced for shared library.

Removal of include `backward/strstream.h`.

Allocator changes. Change `__malloc_alloc` to `malloc_allocator` and `__new_alloc` to `new_allocator`.

For GCC releases from 2.95 through the 3.1 series, defining `__USE_MALLOC` on the `gcc` command line would change the default allocation strategy to instead use `malloc` and `free`. For the 3.2 and 3.3 release series the same functionality was spelled `_GLIBCXX_FORCE_NEW`. From GCC 3.4 onwards the functionality is enabled by setting `GLIBCXX_FORCE_NEW` in the environment, see [the `mt` allocator chapter](#) for details.

Error handling in iostreams cleaned up, made consistent.

B.6.4 3.3**B.6.5 3.4**

Large file support.

Extensions for generic characters and `char_traits` added in `ext/pod_char_traits.h`.

Support for `wchar_t` specializations of `basic_filebuf` enhanced to support UTF-8 and Unicode, depending on host. More hosts support basic `wchar_t` functionality.

Support for `char_traits` beyond builtin types.

Conformant `allocator` class and usage in containers. As part of this, the following extensions are added: `ext/bitmap_allocator.h`, `ext/debug_allocator.h`, `ext/mt_allocator.h`, `ext/malloc_allocator.h`, `ext/new_allocator.h`, `ext/pool_allocator.h`.

This is a change from all previous versions, and may require source-level changes due to allocator-related changes to structures names and template parameters, filenames, and file locations. Some, like `__simple_alloc`, `__allocator`, `__alloc`, and `_Alloc_traits` have been removed.

Default behavior of `std::allocator` has changed.

Previous versions prior to 3.4 cache allocations in a memory pool, instead of passing through to call the global allocation operators (i.e., `__gnu_cxx::pool_allocator`). More recent versions default to the simpler `__gnu_cxx::new_allocator`.

Previously, all allocators were written to the SGI style, and all STL containers expected this interface. This interface had a traits class called `_Alloc_traits` that attempted to provide more information for compile-time allocation selection and optimization. This traits class had another allocator wrapper, `__simple_alloc<T,A>`, which was a wrapper around another allocator, `A`, which itself is an allocator for instances of `T`. But wait, there's more: `__allocator<T,A>` is another adapter. Many of the provided allocator classes were SGI style: such classes can be changed to a conforming interface with this wrapper: `__allocator<T, __alloc>` is thus the same as `allocator<T>`.

The class `allocator` used the typedef `__alloc` to select an underlying allocator that satisfied memory allocation requests. The selection of this underlying allocator was not user-configurable.

Releases after `gcc-3.4` have continued to add to the collection of available allocators. All of these new allocators are standard-style. The following table includes details, along with the first released version of GCC that included the extension allocator.

Allocator (3.4)	Header (3.4)	Allocator (3.[0-3])	Header (3.[0-3])
<code>__gnu_cxx::new_allocator<T></code>	<code>ext/new_allocator.h</code>	<code>std::__new_alloc</code>	memory
<code>__gnu_cxx::malloc_allocator<T></code>	<code>ext/malloc_allocator.h</code>	<code>std::__malloc_allocator<int></code>	memory
<code>__gnu_cxx::debug_allocator<T></code>	<code>ext/debug_allocator.h</code>	<code>std::debug_alloc<T></code>	memory
<code>__gnu_cxx::__pool_alloc<T></code>	<code>ext/pool_allocator.h</code>	<code>std::__default_allocator<bool, int></code>	memory
<code>__gnu_cxx::__mt_alloc<T></code>	<code>ext/mt_allocator.h</code>		
<code>__gnu_cxx::bitmap_allocator<T></code>	<code>ext/bitmap_allocator.h</code>		

Table B.6: Extension Allocators

Allocator	Include	Version
<code>__gnu_cxx::array_allocator<T></code>	<code>ext/array_allocator.h</code>	4.0.0
<code>__gnu_cxx::throw_allocator<T></code>	<code>ext/throw_allocator.h</code>	4.2.0

Table B.7: Extension Allocators Continued

Debug mode first appears.

Precompiled header support PCH support.

Macro guard for changed, from `_GLIBCXX_` to `_GLIBCXX_`.

Extension `ext/stdio_sync_filebuf.h` added.

Extension `ext/demangle.h` added.

B.6.6 4.0

TR1 features first appear.

Extension allocator `ext/array_allocator.h` added.

Extension `codecvt_specializations` moved to `ext/codecvt_specializations.h`.

Removal of `ext/demangle.h`.

B.6.7 4.1

Removal of `cassert` from all standard headers: now has to be explicitly included for `std::assert` calls.

Extensions for policy-based data structures first added. New includes, types, namespace `pb_assoc`.

Extensions for typelists added in `ext/typelist.h`.

Extension for policy-based `basic_string` first added: `__gnu_cxx::__versa_string` in `ext/vstring.h`.

B.6.8 4.2

Default visibility attributes applied to namespace `std`. Support for `-fvisibility`.

TR1 `random`, `complex`, and C compatibility headers added.

Extensions for concurrent programming consolidated into `ext/concurrency.h` and `ext/atomicity.h`, including change of namespace to `__gnu_cxx` in some cases. Added types include `_Lock_policy`, `__concurrency_lock_error`, `__concurrency_unlock_error`, `__mutex`, `__scoped_lock`.

Extensions for type traits consolidated into `ext/type_traits.h`. Additional traits are added (`__conditional_type`, `__enable_if`, others.)

Extensions for policy-based data structures revised. New includes, types, namespace moved to `__pb_ds`.

Extensions for debug mode modified: now nested in namespace `std::__debug` and extensions in namespace `__gnu_cxx::__debug`.

Extensions added: `ext/typelist.h` and `ext/throw_allocator.h`.

B.6.9 4.3

C++0X features first appear.

TR1 `regex` and `cmath`'s mathematical special function added.

Backward include edit.

- Removed

`algbase.h` `algo.h` `alloc.h` `bvector.h` `complex.h` `defalloc.h` `deque.h` `fstream.h` `function.h` `hash_map.h` `hash_set.h` `hashtable.h` `heap.h` `iomanip.h` `iostream.h` `istream.h` `iterator.h` `list.h` `map.h` `multimap.h` `multiset.h` `new.h` `ostream.h` `pair.h` `queue.h` `rope.h` `set.h` `slist.h` `stack.h` `streambuf.h` `stream.h` `tempbuf.h` `tree.h` `vector.h`

- Added

`hash_map` and `hash_set`

- Added in C++11

`auto_ptr.h` and `binders.h`

Header dependency streamlining.

- `algorithm` no longer includes `climits`, `cstring`, or `iosfwd`
- `bitset` no longer includes `istream` or `ostream`, adds `iosfwd`
- `functional` no longer includes `cstddef`
- `iomanip` no longer includes `istream`, `ostream`, or `functional`, adds `ioswd`
- `numeric` no longer includes `iterator`
- `string` no longer includes `algorithm` or `memory`
- `valarray` no longer includes `numeric` or `cstdlib`
- `tr1/hashtable` no longer includes `memory` or `functional`
- `tr1/memory` no longer includes `algorithm`
- `tr1/random` no longer includes `algorithm` or `fstream`

Debug mode for `unordered_map` and `unordered_set`.

Parallel mode first appears.

Variadic template implementations of items in `tuple` and `functional`.

Default what implementations give more elaborate exception strings for `bad_cast`, `bad_typeid`, `bad_exception`, and `bad_alloc`.

PCH binary files no longer installed. Instead, the source files are installed.

Namespace `pb_ds` moved to `__gnu_pb_ds`.

B.6.10 4.4

C++0X features.

- Added.
atomic, chrono, condition_variable, forward_list, initializer_list, mutex, ratio, thread
- Updated and improved.
algorithm, system_error, type_traits
- Use of the GNU extension namespace association converted to inline namespaces.
- Preliminary support for initializer_list and defaulted and deleted constructors in container classes.
- unique_ptr.
- Support for new character types char16_t and char32_t added to char_traits, basic_string, numeric_limits, and assorted compile-time type traits.
- Support for string conversions to_string and to_wstring.
- Member functions taking string arguments were added to iostreams including basic_filebuf, basic_ofstream, and basic_ifstream.
- Exception propagation support, including exception_ptr, current_exception, copy_exception, and rethrow_exception.

Uglification of try to __try and catch to __catch.

Audit of internal mutex usage, conversion to functions returning static local mutex.

Extensions added: ext/pointer.h and ext/extptr_allocator.h. Support for non-standard pointer types has been added to vector and forward_list.

B.6.11 4.5

C++0X features.

- Added.
functional, future, random
- Updated and improved.
atomic, system_error, type_traits
- Add support for explicit operators and standard layout types.

Profile mode first appears.

Support for decimal floating-point arithmetic, including decimal32, decimal64, and decimal128.

Python pretty-printers are added for use with appropriately-advanced versions of **gdb**.

Audit for application of function attributes notrow, const, pure, and noreturn.

The default behavior for comparing typeid names changed, so in typeid, __GXX_MERGED_TYPEID_NAMES now defaults to zero.

Extensions modified: ext/throw_allocator.h.

B.7 Backwards Compatibility

B.7.1 First

The first generation GNU C++ library was called `libg++`. It was a separate GNU project, although reliably paired with GCC. Rumors imply that it had a working relationship with at least two kinds of dinosaur.

Some background: `libg++` was designed and created when there was no ISO standard to provide guidance. Classes like linked lists are now provided for by `list<T>` and do not need to be created by `genclass`. (For that matter, templates exist now and are well-supported, whereas `genclass` (mostly) predates them.)

There are other classes in `libg++` that are not specified in the ISO Standard (e.g., statistical analysis). While there are a lot of really useful things that are used by a lot of people, the Standards Committee couldn't include everything, and so a lot of those "obvious" classes didn't get included.

Known Issues include many of the limitations of its immediate ancestor.

Portability notes and known implementation limitations are as follows.

B.7.1.1 No `ios_base`

At least some older implementations don't have `std::ios_base`, so you should use `std::ios::badbit`, `std::ios::failbit` and `std::ios::eofbit` and `std::ios::goodbit`.

B.7.1.2 No `cout` in `<ostream.h>`, no `cin` in `<istream.h>`

In earlier versions of the standard, `<fstream.h>`, `<ostream.h>` and `<istream.h>` used to define `cout`, `cin` and so on. ISO C++ specifies that one needs to include `<iostream>` explicitly to get the required definitions.

Some include adjustment may be required.

This project is no longer maintained or supported, and the sources archived. For the desperate, the [GCC extensions page](#) describes where to find the last `libg++` source. The code is considered replaced and rewritten.

B.7.2 Second

The second generation GNU C++ library was called `libstdc++`, or `libstdc++-v2`. It spans the time between `libg++` and pre-ISO C++ standardization and is usually associated with the following GCC releases: `egcs 1.x`, `gcc 2.95`, and `gcc 2.96`.

The STL portions of this library are based on SGI/HP STL release 3.11.

This project is no longer maintained or supported, and the sources archived. The code is considered replaced and rewritten.

Portability notes and known implementation limitations are as follows.

B.7.2.1 Namespace `std::`: not supported

Some care is required to support C++ compiler and or library implementation that do not have the standard library in namespace `std`.

The following sections list some possible solutions to support compilers that cannot ignore `std::`-qualified names.

First, see if the compiler has a flag for this. Namespace back-portability-issues are generally not a problem for `g++` compilers that do not have `libstdc++` in `std::`, as the compilers use `-fno-honor-std` (ignore `std::`, `::=std::`) by default. That is, the responsibility for enabling or disabling `std::` is on the user; the maintainer does not have to care about it. This probably applies to some other compilers as well.

Second, experiment with a variety of pre-processor tricks.

By defining `std` as a macro, fully-qualified namespace calls become global. Volia.

```
#ifdef WICKEDLY_OLD_COMPILER
# define std
#endif
```

Thanks to Juergen Heinzl who posted this solution on gnu.gcc.help.

Another pre-processor based approach is to define a macro `NAMESPACE_STD`, which is defined to either `""` or `"std"` based on a compile-type test. On GNU systems, this can be done with autotools by means of an autoconf test (see below) for `HAVE_NAMESPACE_STD`, then using that to set a value for the `NAMESPACE_STD` macro. At that point, one is able to use `NAMESPACE_STD::string`, which will evaluate to `std::string` or `::string` (i.e., in the global namespace on systems that do not put `string` in `std::`).

```
dnl @synopsis AC_CXX_NAMESPACE_STD
dnl
dnl If the compiler supports namespace std, define
dnl HAVE_NAMESPACE_STD.
dnl
dnl @category Cxx
dnl @author Todd Veldhuizen
dnl @author Luc Maisonobe <luc@spaceroots.org>
dnl @version 2004-02-04
dnl @license AllPermissive
AC_DEFUN([AC_CXX_NAMESPACE_STD], [
  AC_CACHE_CHECK(if g++ supports namespace std,
    ac_cv_cxx_have_std_namespace,
    [AC_LANG_SAVE
     AC_LANG_CPLUSPLUS
     AC_TRY_COMPILE([#include <iostream>
                    std::istream& is = std::cin;],,
     ac_cv_cxx_have_std_namespace=yes, ac_cv_cxx_have_std_namespace=no)
     AC_LANG_RESTORE
    ])
  if test "$ac_cv_cxx_have_std_namespace" = yes; then
    AC_DEFINE(HAVE_NAMESPACE_STD,, [Define if g++ supports namespace std. ])
  fi
])
```

B.7.2.2 Illegal iterator usage

The following illustrate implementation-allowed illegal iterator use, and then correct use.

- you cannot do `ostream::operator<<(iterator)` to print the address of the iterator => use `operator<< &*iterator` instead
- you cannot clear an iterator's reference (`iterator = 0`) => use `iterator = iterator_type();`
- if `(iterator)` won't work any more => use `if (iterator != iterator_type())`

B.7.2.3 `isspace` from `<cctype>` is a macro

Glibc 2.0.x and 2.1.x define `<cctype.h>` functionality as macros (`isspace`, `isalpha` etc.).

This implementations of `libstdc++`, however, keep these functions as macros, and so it is not back-portable to use fully qualified names. For example:

```
#include <cctype>
int main() { std::isspace('X'); }
```

Results in something like this:

```
std:: (__ctype_b[(int) ( ( 'X' ) )] & (unsigned short int) _ISspace ) ;
```

A solution is to modify a header-file so that the compiler tells `<ctype.h>` to define functions instead of macros:

```
// This keeps isalnum, et al from being propagated as macros.
#if __linux__
# define __NO_CTYPE 1
#endif
```

Then, include `<ctype.h>`

Another problem arises if you put a `using namespace std;` declaration at the top, and include `<ctype.h>`. This will result in ambiguities between the definitions in the global namespace (`<ctype.h>`) and the definitions in namespace `std::` (`<cctype>`).

B.7.2.4 No `vector::at`, `deque::at`, `string::at`

One solution is to add an autoconf-test for this:

```
AC_MSG_CHECKING(for container::at)
AC_TRY_COMPILE(
[
#include <vector>
#include <deque>
#include <string>

using namespace std;
],
[
deque<int> test_deque(3);
test_deque.at(2);
vector<int> test_vector(2);
test_vector.at(1);
string test_string(test_string);
test_string.at(3);
],
[AC_MSG_RESULT(yes)
AC_DEFINE(HAVE_CONTAINER_AT)],
[AC_MSG_RESULT(no)])
```

If you are using other (non-GNU) compilers it might be a good idea to check for `string::at` separately.

B.7.2.5 No `std::char_traits<char>::eof`

Use some kind of autoconf test, plus this:

```
#ifndef HAVE_CHAR_TRAITS
#define CPP_EOF std::char_traits<char>::eof()
#else
#define CPP_EOF EOF
#endif
```

B.7.2.6 No `string::clear`

There are two functions for deleting the contents of a string: `clear` and `erase` (the latter returns the string).

```
void
clear() { _M_mutate(0, this->size(), 0); }
```

```
basic_string&
erase(size_type __pos = 0, size_type __n = npos)
{
    return this->replace(_M_check(__pos), _M_fold(__pos, __n),
        _M_data(), _M_data());
}
```

Unfortunately, `clear` is not implemented in this version, so you should use `erase` (which is probably faster than `operator=(charT*)`).

B.7.2.7 Removal of `ostream::form` and `istream::scan` extensions

These are no longer supported. Please use stringstreams instead.

B.7.2.8 No `basic_stringbuf`, `basic_stringstream`

Although the ISO standard `i/ostringstream`-classes are provided, (`<sstream>`), for compatibility with older implementations the pre-ISO `i/ostream` (`<strstream>`) interface is also provided, with these caveats:

- `strstream` is considered to be deprecated
- `strstream` is limited to `char`
- with `ostringstream` you don't have to take care of terminating the string or freeing its memory
- `istringstream` can be re-filled (`clear()`; `str(input)`;))

You can then use output-stringstreams like this:

```
#ifdef HAVE_SSTREAM
# include <sstream>
#else
# include <strstream>
#endif

#ifdef HAVE_SSTREAM
    std::ostringstream oss;
#else
    std::ostrstream oss;
#endif

oss << Name= << m_name << , number= << m_number << std::endl;
...
#endif HAVE_SSTREAM
    oss << std::ends; // terminate the char*-string
#endif

// str() returns char* for ostrstream and a string for ostringstream
// this also causes ostrstream to think that the buffer's memory
// is yours
m_label.set_text(oss.str());
#endif HAVE_SSTREAM
    // let the ostrstream take care of freeing the memory
    oss.freeze(false);
#endif
```

Input-stringstreams can be used similarly:

```

std::string input;
...
#ifdef HAVE_SSTREAM
std::istringstream iss(input);
#else
std::istrstream iss(input.c_str());
#endif

int i;
iss >> i;

```

One (the only?) restriction is that an `istrstream` cannot be re-filled:

```

std::istringstream iss(numerator);
iss >> m_num;
// this is not possible with istrstream
iss.clear();
iss.str(denominator);
iss >> m_den;

```

If you don't care about speed, you can put these conversions in a template-function:

```

template <class X>
void fromString(const string& input, X& any)
{
#ifdef HAVE_SSTREAM
std::istringstream iss(input);
#else
std::istrstream iss(input.c_str());
#endif
X temp;
iss >> temp;
if (iss.fail())
throw runtime_error(..)
any = temp;
}

```

Another example of using stringstreams is in [this howto](#).

There is additional information in the `libstdc++-v2` info files, in particular “info iostream”.

B.7.2.9 Little or no wide character support

Classes `wstring` and `char_traits<wchar_t>` are not supported.

B.7.2.10 No templated iostreams

Classes `wfilebuf` and `wstringstream` are not supported.

B.7.2.11 Thread safety issues

Earlier GCC releases had a somewhat different approach to threading configuration and proper compilation. Before GCC 3.0, configuration of the threading model was dictated by compiler command-line options and macros (both of which were somewhat thread-implementation and port-specific). There were no guarantees related to being able to link code compiled with one set of options and macro setting with another set.

For GCC 3.0, configuration of the threading model used with libraries and user-code is performed when GCC is configured and built using the `--enable-threads` and `--disable-threads` options. The ABI is stable for symbol name-mangling and limited functional compatibility exists between code compiled under different threading models.

The libstdc++ library has been designed so that it can be used in multithreaded applications (with libstdc++-v2 this was only true of the STL parts.) The first problem is finding a *fast* method of implementation portable to all platforms. Due to historical reasons, some of the library is written against per-CPU-architecture spinlocks and other parts against the gthr.h abstraction layer which is provided by gcc. A minor problem that pops up every so often is different interpretations of what "thread-safe" means for a library (not a general program). We currently use the [same definition that SGI](#) uses for their STL subset. However, the exception for read-only containers only applies to the STL components. This definition is widely-used and something similar will be used in the next version of the C++ standard library.

Here is a small link farm to threads (no pun) in the mail archives that discuss the threading problem. Each link is to the first relevant message in the thread; from there you can use "Thread Next" to move down the thread. This farm is in latest-to-oldest order.

- Our threading expert Loren gives a breakdown of [the six situations involving threads](#) for the 3.0 release series.
- [This message](#) inspired a recent updating of issues with threading and the SGI STL library. It also contains some example POSIX-multithreaded STL code.

(A large selection of links to older messages has been removed; many of the messages from 1999 were lost in a disk crash, and the few people with access to the backup tapes have been too swamped with work to restore them. Many of the points have been superseded anyhow.)

B.7.3 Third

The third generation GNU C++ library is called libstdc++, or libstdc++-v3.

The subset commonly known as the Standard Template Library (clauses 23 through 25, mostly) is adapted from the final release of the SGI STL (version 3.3), with extensive changes.

A more formal description of the V3 goals can be found in the official [design document](#).

Portability notes and known implementation limitations are as follows.

B.7.3.1 Pre-ISO headers moved to backwards or removed

The pre-ISO C++ headers (<iostream.h>, <defalloc.h> etc.) are available, unlike previous libstdc++ versions, but inclusion generates a warning that you are using deprecated headers.

This compatibility layer is constructed by including the standard C++ headers, and injecting any items in `std::` into the global namespace.

For those of you new to ISO C++ (welcome, time travelers!), no, that isn't a typo. Yes, the headers really have new names. Marshall Cline's C++ FAQ Lite has a good explanation in [What's the difference between <xxx> and <xxx.h> headers?](#).

Some include adjustment may be required. What follows is an autoconf test that defines `PRE_STDCXX_HEADERS` when they exist.

```
# AC_HEADER_PRE_STDCXX
AC_DEFUN([AC_HEADER_PRE_STDCXX], [
  AC_CACHE_CHECK(for pre-ISO C++ include files,
    ac_cv_cxx_pre_stdcxx,
    [AC_LANG_SAVE
     AC_LANG_CPLUSPLUS
     ac_save_CXXFLAGS="$CXXFLAGS"
     CXXFLAGS="$CXXFLAGS -Wno-deprecated"

     # Omit defalloc.h, as compilation with newer compilers is problematic.
     AC_TRY_COMPILE([
       #include <new.h>
       #include <iterator.h>
       #include <alloc.h>
```

```

#include <set.h>
#include <hashtable.h>
#include <hash_set.h>
#include <fstream.h>
#include <tempbuf.h>
#include <istream.h>
#include <bvector.h>
#include <stack.h>
#include <rope.h>
#include <complex.h>
#include <ostream.h>
#include <heap.h>
#include <iostream.h>
#include <function.h>
#include <multimap.h>
#include <pair.h>
#include <stream.h>
#include <iomanip.h>
#include <slight.h>
#include <tree.h>
#include <vector.h>
#include <deque.h>
#include <multiset.h>
#include <list.h>
#include <map.h>
#include <algorith.h>
#include <hash_map.h>
#include <algo.h>
#include <queue.h>
#include <streambuf.h>
],,
ac_cv_cxx_pre_stdccx=yes, ac_cv_cxx_pre_stdccx=no)
CXXFLAGS="$ac_save_CXXFLAGS"
AC_LANG_RESTORE
])
if test "$ac_cv_cxx_pre_stdccx" = yes; then
    AC_DEFINE(PRE_STDCXX_HEADERS,, [Define if pre-ISO C++ header files are present. ])
fi
])

```

Porting between pre-ISO headers and ISO headers is simple: headers like `<vector.h>` can be replaced with `<vector>` and a using directive using namespace `std`; can be put at the global scope. This should be enough to get this code compiling, assuming the other usage is correct.

B.7.3.2 Extension headers `hash_map`, `hash_set` moved to `ext` or backwards

At this time most of the features of the SGI STL extension have been replaced by standardized libraries. In particular, the `unordered_map` and `unordered_set` containers of TR1 and C++ 2011 are suitable replacements for the non-standard `hash_map` and `hash_set` containers in the SGI STL.

Header files `<hash_map>` and `<hash_set>` moved to `<ext/hash_map>` and `<ext/hash_set>`, respectively. At the same time, all types in these files are enclosed in namespace `__gnu_cxx`. Later versions deprecate these files, and suggest using TR1's `<unordered_map>` and `<unordered_set>` instead.

The extensions are no longer in the global or `std` namespaces, instead they are declared in the `__gnu_cxx` namespace. For maximum portability, consider defining a namespace alias to use to talk about extensions, e.g.:

```

#ifdef __GNUC__
    #if __GNUC__ < 3
        #include <hash_map.h>
        namespace extension { using ::hash_map; }; // inherit globals
    }

```

```

    #else
#include <backward/hash_map>
#if __GNUC__ == 3 && __GNUC_MINOR__ == 0
    namespace extension = std;           // GCC 3.0
#else
    namespace extension = ::__gnu_cxx;   // GCC 3.1 and later
#endif
#endif
    #else // ... there are other compilers, right?
namespace extension = std;
    #endif

    extension::hash_map<int,int> my_map;

```

This is a bit cleaner than defining typedefs for all the instantiations you might need.

The following autoconf tests check for working HP/SGI hash containers.

```

# AC_HEADER_EXT_HASH_MAP
AC_DEFUN([AC_HEADER_EXT_HASH_MAP], [
    AC_CACHE_CHECK(for ext/hash_map,
    ac_cv_cxx_ext_hash_map,
    [AC_LANG_SAVE
    AC_LANG_CPLUSPLUS
    ac_save_CXXFLAGS="$CXXFLAGS"
    CXXFLAGS="$CXXFLAGS -Werror"
    AC_TRY_COMPILE([#include <ext/hash_map>], [using __gnu_cxx::hash_map;],
    ac_cv_cxx_ext_hash_map=yes, ac_cv_cxx_ext_hash_map=no)
    CXXFLAGS="$ac_save_CXXFLAGS"
    AC_LANG_RESTORE
    ])
    if test "$ac_cv_cxx_ext_hash_map" = yes; then
        AC_DEFINE(HAVE_EXT_HASH_MAP,, [Define if ext/hash_map is present. ])
    fi
])

```

```

# AC_HEADER_EXT_HASH_SET
AC_DEFUN([AC_HEADER_EXT_HASH_SET], [
    AC_CACHE_CHECK(for ext/hash_set,
    ac_cv_cxx_ext_hash_set,
    [AC_LANG_SAVE
    AC_LANG_CPLUSPLUS
    ac_save_CXXFLAGS="$CXXFLAGS"
    CXXFLAGS="$CXXFLAGS -Werror"
    AC_TRY_COMPILE([#include <ext/hash_set>], [using __gnu_cxx::hash_set;],
    ac_cv_cxx_ext_hash_set=yes, ac_cv_cxx_ext_hash_set=no)
    CXXFLAGS="$ac_save_CXXFLAGS"
    AC_LANG_RESTORE
    ])
    if test "$ac_cv_cxx_ext_hash_set" = yes; then
        AC_DEFINE(HAVE_EXT_HASH_SET,, [Define if ext/hash_set is present. ])
    fi
])

```

B.7.3.3 No ios::nocreate/ios::noreplace.

Historically these flags were used with iostreams to control whether new files are created or not when opening a file stream, similar to the O_CREAT and O_EXCL flags for the open(2) system call. Because iostream modes correspond to fopen(3) modes these flags are not supported. For input streams a new file will not be created anyway, so ios::nocreate is not needed. For output streams, a new file will be created if it does not exist, which is consistent with the behaviour of fopen.

When one of these flags is needed a possible alternative is to attempt to open the file using `std::ifstream` first to determine whether the file already exists or not. This may not be reliable however, because whether the file exists or not could change between opening the `std::istream` and re-opening with an output stream. If you need to check for existence and open a file as a single operation then you will need to use OS-specific facilities outside the C++ standard library, such as `open(2)`.

B.7.3.4 No `stream::attach(int fd)`

Phil Edwards writes: It was considered and rejected for the ISO standard. Not all environments use file descriptors. Of those that do, not all of them use integers to represent them.

For a portable solution (among systems which use file descriptors), you need to implement a subclass of `std::streambuf` (or `std::basic_streambuf<...>`) which opens a file given a descriptor, and then pass an instance of this to the stream-constructor.

An extension is available that implements this. `<ext/stdio_filebuf.h>` contains a derived class called `__gnu_cxx::stdio_filebuf`. This class can be constructed from a `C FILE*` or a file descriptor, and provides the `fd()` function.

For another example of this, refer to [fdstream example](#) by Nicolai Josuttis.

B.7.3.5 Support for C++98 dialect.

Check for complete library coverage of the C++1998/2003 standard.

```
# AC_HEADER_STDCXX_98
AC_DEFUN([AC_HEADER_STDCXX_98], [
  AC_CACHE_CHECK(for ISO C++ 98 include files,
    ac_cv_cxx_stdcxx_98,
    [AC_LANG_SAVE
     AC_LANG_CPLUSPLUS
     AC_TRY_COMPILE([
       #include <cassert>
       #include <cctype>
       #include <cerrno>
       #include <cfloat>
       #include <ciso646>
       #include <climits>
       #include <locale>
       #include <cmath>
       #include <csetjmp>
       #include <csignal>
       #include <cstdarg>
       #include <cstddef>
       #include <cstdio>
       #include <cstdlib>
       #include <cstring>
       #include <ctime>

       #include <algorithm>
       #include <bitset>
       #include <complex>
       #include <deque>
       #include <exception>
       #include <fstream>
       #include <functional>
       #include <iomanip>
       #include <ios>
       #include <iosfwd>
       #include <iostream>
       #include <istream>
       #include <iterator>
       #include <limits>
```

```

#include <list>
#include <locale>
#include <map>
#include <memory>
#include <new>
#include <numeric>
#include <ostream>
#include <queue>
#include <set>
#include <sstream>
#include <stack>
#include <stdexcept>
#include <streambuf>
#include <string>
#include <typeinfo>
#include <utility>
#include <valarray>
#include <vector>
),,
ac_cv_cxx_stdcxx_98=yes, ac_cv_cxx_stdcxx_98=no)
AC_LANG_RESTORE
])
if test "$ac_cv_cxx_stdcxx_98" = yes; then
  AC_DEFINE(STDCCXX_98_HEADERS,, [Define if ISO C++ 1998 header files are present. ])
fi
])

```

B.7.3.6 Support for C++TR1 dialect.

Check for library coverage of the TR1 standard.

```

# AC_HEADER_STDCXX_TR1
AC_DEFUN([AC_HEADER_STDCXX_TR1], [
  AC_CACHE_CHECK(for ISO C++ TR1 include files,
    ac_cv_cxx_stdcxx_tr1,
    [AC_LANG_SAVE
     AC_LANG_CPLUSPLUS
     AC_TRY_COMPILE([
#include <tr1/array>
#include <tr1/complex>
#include <tr1/cctype>
#include <tr1/cfenv>
#include <tr1/cfloat>
#include <tr1/cinttypes>
#include <tr1/climits>
#include <tr1/cmath>
#include <tr1/complex>
#include <tr1/cstdarg>
#include <tr1/cstdbool>
#include <tr1/cstdint>
#include <tr1/cstdio>
#include <tr1/cstdlib>
#include <tr1/ctgmath>
#include <tr1/ctime>
#include <tr1/cwchar>
#include <tr1/cwctype>
#include <tr1/functional>
#include <tr1/memory>
#include <tr1/random>
#include <tr1/regex>

```

```

#include <tr1/tuple>
#include <tr1/type_traits>
#include <tr1/unordered_set>
#include <tr1/unordered_map>
#include <tr1/utility>
],,
ac_cv_cxx_stdcxx_tr1=yes, ac_cv_cxx_stdcxx_tr1=no)
AC_LANG_RESTORE
])
if test "$ac_cv_cxx_stdcxx_tr1" = yes; then
    AC_DEFINE(STDCXX_TR1_HEADERS,, [Define if ISO C++ TR1 header files are present. ])
fi
])

```

An alternative is to check just for specific TR1 includes, such as `<unordered_map>` and `<unordered_set>`.

```

# AC_HEADER_TR1_UNORDERED_MAP
AC_DEFUN([AC_HEADER_TR1_UNORDERED_MAP], [
    AC_CACHE_CHECK(for tr1/unordered_map,
        ac_cv_cxx_tr1_unordered_map,
        [AC_LANG_SAVE
         AC_LANG_CPLUSPLUS
         AC_TRY_COMPILE([#include <tr1/unordered_map>], [using std::tr1::unordered_map;],
            ac_cv_cxx_tr1_unordered_map=yes, ac_cv_cxx_tr1_unordered_map=no)
         AC_LANG_RESTORE
        ])
    if test "$ac_cv_cxx_tr1_unordered_map" = yes; then
        AC_DEFINE(HAVE_TR1_UNORDERED_MAP,, [Define if tr1/unordered_map is present. ])
    fi
])

```

```

# AC_HEADER_TR1_UNORDERED_SET
AC_DEFUN([AC_HEADER_TR1_UNORDERED_SET], [
    AC_CACHE_CHECK(for tr1/unordered_set,
        ac_cv_cxx_tr1_unordered_set,
        [AC_LANG_SAVE
         AC_LANG_CPLUSPLUS
         AC_TRY_COMPILE([#include <tr1/unordered_set>], [using std::tr1::unordered_set;],
            ac_cv_cxx_tr1_unordered_set=yes, ac_cv_cxx_tr1_unordered_set=no)
         AC_LANG_RESTORE
        ])
    if test "$ac_cv_cxx_tr1_unordered_set" = yes; then
        AC_DEFINE(HAVE_TR1_UNORDERED_SET,, [Define if tr1/unordered_set is present. ])
    fi
])

```

B.7.3.7 Support for C++11 dialect.

Check for baseline language coverage in the compiler for the C++11 standard.

```

# AC_COMPILE_STDCXX_11
AC_DEFUN([AC_COMPILE_STDCXX_11], [
    AC_CACHE_CHECK(if g++ supports C++11 features without additional flags,
        ac_cv_cxx_compile_cxx11_native,
        [AC_LANG_SAVE
         AC_LANG_CPLUSPLUS
         AC_TRY_COMPILE([
template <typename T>
    struct check final
    {

```

```

    static constexpr T value{ __cplusplus };
};

typedef check<check<bool>> right_angle_brackets;

int a;
decltype(a) b;

typedef check<int> check_type;
check_type c{};
check_type&& cr = static_cast<check_type&&>(c);

    static_assert(check_type::value == 201103L, "C++11 compiler");],,,
ac_cv_cxx_compile_cxx11_native=yes, ac_cv_cxx_compile_cxx11_native=no)
AC_LANG_RESTORE
])

AC_CACHE_CHECK(if g++ supports C++11 features with -std=c++11,
ac_cv_cxx_compile_cxx11_cxx,
[AC_LANG_SAVE
AC_LANG_CPLUSPLUS
ac_save_CXXFLAGS="$CXXFLAGS"
CXXFLAGS="$CXXFLAGS -std=c++11"
AC_TRY_COMPILE([
template <typename T>
struct check final
{
    static constexpr T value{ __cplusplus };
};

typedef check<check<bool>> right_angle_brackets;

int a;
decltype(a) b;

typedef check<int> check_type;
check_type c{};
check_type&& cr = static_cast<check_type&&>(c);

    static_assert(check_type::value == 201103L, "C++11 compiler");],,,
ac_cv_cxx_compile_cxx11_cxx=yes, ac_cv_cxx_compile_cxx11_cxx=no)
CXXFLAGS="$ac_save_CXXFLAGS"
AC_LANG_RESTORE
])

AC_CACHE_CHECK(if g++ supports C++11 features with -std=gnu++11,
ac_cv_cxx_compile_cxx11_gxx,
[AC_LANG_SAVE
AC_LANG_CPLUSPLUS
ac_save_CXXFLAGS="$CXXFLAGS"
CXXFLAGS="$CXXFLAGS -std=gnu++11"
AC_TRY_COMPILE([
template <typename T>
struct check final
{
    static constexpr T value{ __cplusplus };
};

typedef check<check<bool>> right_angle_brackets;

int a;
decltype(a) b;

```

```

typedef check<int> check_type;
check_type c{};
check_type&& cr = static_cast<check_type&&>(c);

    static_assert(check_type::value == 201103L, "C++11 compiler");],,
ac_cv_cxx_compile_cxx11_gxx=yes, ac_cv_cxx_compile_cxx11_gxx=no)
CXXFLAGS="$ac_save_CXXFLAGS"
AC_LANG_RESTORE
])

if test "$ac_cv_cxx_compile_cxx11_native" = yes ||
    test "$ac_cv_cxx_compile_cxx11_cxx" = yes ||
    test "$ac_cv_cxx_compile_cxx11_gxx" = yes; then
    AC_DEFINE(HAVE_STDCXX_11,, [Define if g++ supports C++11 features. ])
fi
])

```

Check for library coverage of the C++2011 standard. (Some library headers are commented out in this check, they are not currently provided by libstdc++).

```

# AC_HEADER_STDCXX_11
AC_DEFUN([AC_HEADER_STDCXX_11], [
    AC_CACHE_CHECK(for ISO C++11 include files,
ac_cv_cxx_stdcxx_11,
[AC_REQUIRE([AC_COMPILE_STDCXX_11])
AC_LANG_SAVE
AC_LANG_CPLUSPLUS
ac_save_CXXFLAGS="$CXXFLAGS"
CXXFLAGS="$CXXFLAGS -std=gnu++11"

AC_TRY_COMPILE([
    #include <cassert>
    #include <ccomplex>
    #include <cctype>
    #include <cerrno>
    #include <cfenv>
    #include <cfloat>
    #include < cinttypes>
    #include <ciso646>
    #include <climits>
    #include <locale>
    #include <cmath>
    #include < csetjmp>
    #include < csignal>
    #include < cstdalign>
    #include < cstdarg>
    #include < cstdbool>
    #include < cstddef>
    #include < cstdint>
    #include < cstdio>
    #include < cstdlib>
    #include < cstring>
    #include < ctgmath>
    #include < ctime>
    // #include < cuchar>
    #include < cwchar>
    #include < cwctype>

    #include <algorithm>
    #include <array>
    #include <atomic>

```

```
#include <bitset>
#include <chrono>
// #include <codecvt>
#include <complex>
#include <condition_variable>
#include <deque>
#include <exception>
#include <forward_list>
#include <fstream>
#include <functional>
#include <future>
#include <initializer_list>
#include <iomanip>
#include <ios>
#include <iosfwd>
#include <iostream>
#include <istream>
#include <iterator>
#include <limits>
#include <list>
#include <locale>
#include <map>
#include <memory>
#include <mutex>
#include <new>
#include <numeric>
#include <ostream>
#include <queue>
#include <random>
#include <ratio>
#include <regex>
#include <scoped_allocator>
#include <set>
#include <sstream>
#include <stack>
#include <stdexcept>
#include <streambuf>
#include <string>
#include <system_error>
#include <thread>
#include <tuple>
#include <typeindex>
#include <typeinfo>
#include <type_traits>
#include <unordered_map>
#include <unordered_set>
#include <utility>
#include <valarray>
#include <vector>
),,
ac_cv_cxx_stdcxx_11=yes, ac_cv_cxx_stdcxx_11=no)
AC_LANG_RESTORE
CXXFLAGS="$ac_save_CXXFLAGS"
)
if test "$ac_cv_cxx_stdcxx_11" = yes; then
  AC_DEFINE(STDCXX_11_HEADERS,, [Define if ISO C++11 header files are present. ])
fi
)
)
```

As is the case for TR1 support, these autoconf macros can be made for a finer-grained, per-header-file check. For `<unordered_map>`

```
# AC_HEADER_UNORDERED_MAP
AC_DEFUN([AC_HEADER_UNORDERED_MAP], [
  AC_CACHE_CHECK(for unordered_map,
    ac_cv_cxx_unordered_map,
    [AC_REQUIRE([AC_COMPILE_STDCXX_11])
     AC_LANG_SAVE
     AC_LANG_CPLUSPLUS
     ac_save_CXXFLAGS="$CXXFLAGS"
     CXXFLAGS="$CXXFLAGS -std=gnu++11"
     AC_TRY_COMPILE([#include <unordered_map>], [using std::unordered_map;],
       ac_cv_cxx_unordered_map=yes, ac_cv_cxx_unordered_map=no)
     CXXFLAGS="$ac_save_CXXFLAGS"
     AC_LANG_RESTORE
    ])
  if test "$ac_cv_cxx_unordered_map" = yes; then
    AC_DEFINE(HAVE_UNORDERED_MAP,, [Define if unordered_map is present. ])
  fi
])
```

```
# AC_HEADER_UNORDERED_SET
AC_DEFUN([AC_HEADER_UNORDERED_SET], [
  AC_CACHE_CHECK(for unordered_set,
    ac_cv_cxx_unordered_set,
    [AC_REQUIRE([AC_COMPILE_STDCXX_11])
     AC_LANG_SAVE
     AC_LANG_CPLUSPLUS
     ac_save_CXXFLAGS="$CXXFLAGS"
     CXXFLAGS="$CXXFLAGS -std=gnu++11"
     AC_TRY_COMPILE([#include <unordered_set>], [using std::unordered_set;],
       ac_cv_cxx_unordered_set=yes, ac_cv_cxx_unordered_set=no)
     CXXFLAGS="$ac_save_CXXFLAGS"
     AC_LANG_RESTORE
    ])
  if test "$ac_cv_cxx_unordered_set" = yes; then
    AC_DEFINE(HAVE_UNORDERED_SET,, [Define if unordered_set is present. ])
  fi
])
```

Some C++11 features first appeared in GCC 4.3 and could be enabled by `-std=c++0x` and `-std=gnu++0x` for GCC releases which pre-date the 2011 standard. Those C++11 features and GCC's support for them were still changing until the 2011 standard was finished, but the autoconf checks above could be extended to test for incomplete C++11 support with `-std=c++0x` and `-std=gnu++0x`.

B.7.3.8 `Container::iterator_type` is not necessarily `Container::value_type*`

This is a change in behavior from older versions. Now, most `iterator_type` typedefs in container classes are POD objects, not `value_type` pointers.

B.7.4 Bibliography

- [109] Dan Kegel, *Migrating to GCC 4.1*
- [110] Martin Michlmayr, *Building the Whole Debian Archive with GCC 4.1: A Summary*
- [111] *Migration guide for GCC-3.2*

Appendix C

Free Software Needs Free Documentation

The biggest deficiency in free operating systems is not in the software--it is the lack of good free manuals that we can include in these systems. Many of our most important programs do not come with full manuals. Documentation is an essential part of any software package; when an important free software package does not come with a free manual, that is a major gap. We have many such gaps today.

Once upon a time, many years ago, I thought I would learn Perl. I got a copy of a free manual, but I found it hard to read. When I asked Perl users about alternatives, they told me that there were better introductory manuals--but those were not free.

Why was this? The authors of the good manuals had written them for O'Reilly Associates, which published them with restrictive terms--no copying, no modification, source files not available--which exclude them from the free software community.

That wasn't the first time this sort of thing has happened, and (to our community's great loss) it was far from the last. Proprietary manual publishers have enticed a great many authors to restrict their manuals since then. Many times I have heard a GNU user eagerly tell me about a manual that he is writing, with which he expects to help the GNU project--and then had my hopes dashed, as he proceeded to explain that he had signed a contract with a publisher that would restrict it so that we cannot use it.

Given that writing good English is a rare skill among programmers, we can ill afford to lose manuals this way.

Free documentation, like free software, is a matter of freedom, not price. The problem with these manuals was not that O'Reilly Associates charged a price for printed copies--that in itself is fine. (The Free Software Foundation [sells printed copies](#) of free GNU manuals, too.) But GNU manuals are available in source code form, while these manuals are available only on paper. GNU manuals come with permission to copy and modify; the Perl manuals do not. These restrictions are the problems.

The criterion for a free manual is pretty much the same as for free software: it is a matter of giving all users certain freedoms. Redistribution (including commercial redistribution) must be permitted, so that the manual can accompany every copy of the program, on-line or on paper. Permission for modification is crucial too.

As a general rule, I don't believe that it is essential for people to have permission to modify all sorts of articles and books. The issues for writings are not necessarily the same as those for software. For example, I don't think you or I are obliged to give permission to modify articles like this one, which describe our actions and our views.

But there is a particular reason why the freedom to modify is crucial for documentation for free software. When people exercise their right to modify the software, and add or change its features, if they are conscientious they will change the manual too--so they can provide accurate and usable documentation with the modified program. A manual which forbids programmers to be conscientious and finish the job, or more precisely requires them to write a new manual from scratch if they change the program, does not fill our community's needs.

While a blanket prohibition on modification is unacceptable, some kinds of limits on the method of modification pose no problem. For example, requirements to preserve the original author's copyright notice, the distribution terms, or the list of authors, are ok. It is also no problem to require modified versions to include notice that they were modified, even to have entire sections that may not be deleted or changed, as long as these sections deal with nontechnical topics. (Some GNU manuals have them.)

These kinds of restrictions are not a problem because, as a practical matter, they don't stop the conscientious programmer from adapting the manual to fit the modified program. In other words, they don't block the free software community from making full use of the manual.

However, it must be possible to modify all the *technical* content of the manual, and then distribute the result in all the usual media, through all the usual channels; otherwise, the restrictions do block the community, the manual is not free, and so we need another manual.

Unfortunately, it is often hard to find someone to write another manual when a proprietary manual exists. The obstacle is that many users think that a proprietary manual is good enough--so they don't see the need to write a free manual. They do not see that the free operating system has a gap that needs filling.

Why do users think that proprietary manuals are good enough? Some have not considered the issue. I hope this article will do something to change that.

Other users consider proprietary manuals acceptable for the same reason so many people consider proprietary software acceptable: they judge in purely practical terms, not using freedom as a criterion. These people are entitled to their opinions, but since those opinions spring from values which do not include freedom, they are no guide for those of us who do value freedom.

Please spread the word about this issue. We continue to lose manuals to proprietary publishing. If we spread the word that proprietary manuals are not sufficient, perhaps the next person who wants to help GNU by writing documentation will realize, before it is too late, that he must above all make it free.

We can also encourage commercial publishers to sell free, copylefted manuals instead of proprietary ones. One way you can help this is to check the distribution terms of a manual before you buy it, and prefer copylefted manuals to non-copylefted ones.

[Note: We now maintain a [web page that lists free books available from other publishers](#)].

Copyright © 2004, 2005, 2006, 2007 Free Software Foundation, Inc., 51 Franklin Street, Fifth Floor, Boston, MA 02110-1301, USA

Verbatim copying and distribution of this entire article are permitted worldwide, without royalty, in any medium, provided this notice is preserved.

Report any problems or suggestions to webmaster@fsf.org.

Appendix D

GNU General Public License version 3

Version 3, 29 June 2007

Copyright © 2007 Free Software Foundation, Inc. <http://www.fsf.org/>

Everyone is permitted to copy and distribute verbatim copies of this license document, but changing it is not allowed.

Preamble

The GNU General Public License is a free, copyleft license for software and other kinds of works.

The licenses for most software and other practical works are designed to take away your freedom to share and change the works. By contrast, the GNU General Public License is intended to guarantee your freedom to share and change all versions of a program—to make sure it remains free software for all its users. We, the Free Software Foundation, use the GNU General Public License for most of our software; it applies also to any other work released this way by its authors. You can apply it to your programs, too.

When we speak of free software, we are referring to freedom, not price. Our General Public Licenses are designed to make sure that you have the freedom to distribute copies of free software (and charge for them if you wish), that you receive source code or can get it if you want it, that you can change the software or use pieces of it in new free programs, and that you know you can do these things.

To protect your rights, we need to prevent others from denying you these rights or asking you to surrender the rights. Therefore, you have certain responsibilities if you distribute copies of the software, or if you modify it: responsibilities to respect the freedom of others.

For example, if you distribute copies of such a program, whether gratis or for a fee, you must pass on to the recipients the same freedoms that you received. You must make sure that they, too, receive or can get the source code. And you must show them these terms so they know their rights.

Developers that use the GNU GPL protect your rights with two steps: (1) assert copyright on the software, and (2) offer you this License giving you legal permission to copy, distribute and/or modify it.

For the developers' and authors' protection, the GPL clearly explains that there is no warranty for this free software. For both users' and authors' sake, the GPL requires that modified versions be marked as changed, so that their problems will not be attributed erroneously to authors of previous versions.

Some devices are designed to deny users access to install or run modified versions of the software inside them, although the manufacturer can do so. This is fundamentally incompatible with the aim of protecting users' freedom to change the software. The systematic pattern of such abuse occurs in the area of products for individuals to use, which is precisely where it is most unacceptable. Therefore, we have designed this version of the GPL to prohibit the practice for those products. If such problems arise substantially in other domains, we stand ready to extend this provision to those domains in future versions of the GPL, as needed to protect the freedom of users.

Finally, every program is threatened constantly by software patents. States should not allow patents to restrict development and use of software on general-purpose computers, but in those that do, we wish to avoid the special danger that patents applied to a free program could make it effectively proprietary. To prevent this, the GPL assures that patents cannot be used to render the program non-free.

The precise terms and conditions for copying, distribution and modification follow.

TERMS AND CONDITIONS

0. Definitions.

“This License” refers to version 3 of the GNU General Public License.

“Copyright” also means copyright-like laws that apply to other kinds of works, such as semiconductor masks.

“The Program” refers to any copyrightable work licensed under this License. Each licensee is addressed as “you”. “Licensees” and “recipients” may be individuals or organizations.

To “modify” a work means to copy from or adapt all or part of the work in a fashion requiring copyright permission, other than the making of an exact copy. The resulting work is called a “modified version” of the earlier work or a work “based on” the earlier work.

A “covered work” means either the unmodified Program or a work based on the Program.

To “propagate” a work means to do anything with it that, without permission, would make you directly or secondarily liable for infringement under applicable copyright law, except executing it on a computer or modifying a private copy. Propagation includes copying, distribution (with or without modification), making available to the public, and in some countries other activities as well.

To “convey” a work means any kind of propagation that enables other parties to make or receive copies. Mere interaction with a user through a computer network, with no transfer of a copy, is not conveying.

An interactive user interface displays “Appropriate Legal Notices” to the extent that it includes a convenient and prominently visible feature that (1) displays an appropriate copyright notice, and (2) tells the user that there is no warranty for the work (except to the extent that warranties are provided), that licensees may convey the work under this License, and how to view a copy of this License. If the interface presents a list of user commands or options, such as a menu, a prominent item in the list meets this criterion.

1. Source Code.

The “source code” for a work means the preferred form of the work for making modifications to it. “Object code” means any non-source form of a work.

A “Standard Interface” means an interface that either is an official standard defined by a recognized standards body, or, in the case of interfaces specified for a particular programming language, one that is widely used among developers working in that language.

The “System Libraries” of an executable work include anything, other than the work as a whole, that (a) is included in the normal form of packaging a Major Component, but which is not part of that Major Component, and (b) serves only to enable use of the work with that Major Component, or to implement a Standard Interface for which an implementation is available to the public in source code form. A “Major Component”, in this context, means a major essential component (kernel, window system, and so on) of the specific operating system (if any) on which the executable work runs, or a compiler used to produce the work, or an object code interpreter used to run it.

The “Corresponding Source” for a work in object code form means all the source code needed to generate, install, and (for an executable work) run the object code and to modify the work, including scripts to control those activities. However, it does not include the work’s System Libraries, or general-purpose tools or generally available free programs which are used unmodified in performing those activities but which are not part of the work. For example, Corresponding Source includes interface definition files associated with source files for the work, and the source code for shared libraries and dynamically linked subprograms that

the work is specifically designed to require, such as by intimate data communication or control flow between those subprograms and other parts of the work.

The Corresponding Source need not include anything that users can regenerate automatically from other parts of the Corresponding Source.

The Corresponding Source for a work in source code form is that same work.

2. Basic Permissions.

All rights granted under this License are granted for the term of copyright on the Program, and are irrevocable provided the stated conditions are met. This License explicitly affirms your unlimited permission to run the unmodified Program. The output from running a covered work is covered by this License only if the output, given its content, constitutes a covered work. This License acknowledges your rights of fair use or other equivalent, as provided by copyright law.

You may make, run and propagate covered works that you do not convey, without conditions so long as your license otherwise remains in force. You may convey covered works to others for the sole purpose of having them make modifications exclusively for you, or provide you with facilities for running those works, provided that you comply with the terms of this License in conveying all material for which you do not control copyright. Those thus making or running the covered works for you must do so exclusively on your behalf, under your direction and control, on terms that prohibit them from making any copies of your copyrighted material outside their relationship with you.

Conveying under any other circumstances is permitted solely under the conditions stated below. Sublicensing is not allowed; section 10 makes it unnecessary.

3. Protecting Users' Legal Rights From Anti-Circumvention Law.

No covered work shall be deemed part of an effective technological measure under any applicable law fulfilling obligations under article 11 of the WIPO copyright treaty adopted on 20 December 1996, or similar laws prohibiting or restricting circumvention of such measures.

When you convey a covered work, you waive any legal power to forbid circumvention of technological measures to the extent such circumvention is effected by exercising rights under this License with respect to the covered work, and you disclaim any intention to limit operation or modification of the work as a means of enforcing, against the work's users, your or third parties' legal rights to forbid circumvention of technological measures.

4. Conveying Verbatim Copies.

You may convey verbatim copies of the Program's source code as you receive it, in any medium, provided that you conspicuously and appropriately publish on each copy an appropriate copyright notice; keep intact all notices stating that this License and any non-permissive terms added in accord with section 7 apply to the code; keep intact all notices of the absence of any warranty; and give all recipients a copy of this License along with the Program.

You may charge any price or no price for each copy that you convey, and you may offer support or warranty protection for a fee.

5. Conveying Modified Source Versions.

You may convey a work based on the Program, or the modifications to produce it from the Program, in the form of source code under the terms of section 4, provided that you also meet all of these conditions:

- a. The work must carry prominent notices stating that you modified it, and giving a relevant date.
 - b. The work must carry prominent notices stating that it is released under this License and any conditions added under section 7. This requirement modifies the requirement in section 4 to "keep intact all notices".
-

- c. You must license the entire work, as a whole, under this License to anyone who comes into possession of a copy. This License will therefore apply, along with any applicable section 7 additional terms, to the whole of the work, and all its parts, regardless of how they are packaged. This License gives no permission to license the work in any other way, but it does not invalidate such permission if you have separately received it.
- d. If the work has interactive user interfaces, each must display Appropriate Legal Notices; however, if the Program has interactive interfaces that do not display Appropriate Legal Notices, your work need not make them do so.

A compilation of a covered work with other separate and independent works, which are not by their nature extensions of the covered work, and which are not combined with it such as to form a larger program, in or on a volume of a storage or distribution medium, is called an “aggregate” if the compilation and its resulting copyright are not used to limit the access or legal rights of the compilation’s users beyond what the individual works permit. Inclusion of a covered work in an aggregate does not cause this License to apply to the other parts of the aggregate.

6. Conveying Non-Source Forms.

You may convey a covered work in object code form under the terms of sections 4 and 5, provided that you also convey the machine-readable Corresponding Source under the terms of this License, in one of these ways:

- a. Convey the object code in, or embodied in, a physical product (including a physical distribution medium), accompanied by the Corresponding Source fixed on a durable physical medium customarily used for software interchange.
- b. Convey the object code in, or embodied in, a physical product (including a physical distribution medium), accompanied by a written offer, valid for at least three years and valid for as long as you offer spare parts or customer support for that product model, to give anyone who possesses the object code either (1) a copy of the Corresponding Source for all the software in the product that is covered by this License, on a durable physical medium customarily used for software interchange, for a price no more than your reasonable cost of physically performing this conveying of source, or (2) access to copy the Corresponding Source from a network server at no charge.
- c. Convey individual copies of the object code with a copy of the written offer to provide the Corresponding Source. This alternative is allowed only occasionally and noncommercially, and only if you received the object code with such an offer, in accord with subsection 6b.
- d. Convey the object code by offering access from a designated place (gratis or for a charge), and offer equivalent access to the Corresponding Source in the same way through the same place at no further charge. You need not require recipients to copy the Corresponding Source along with the object code. If the place to copy the object code is a network server, the Corresponding Source may be on a different server (operated by you or a third party) that supports equivalent copying facilities, provided you maintain clear directions next to the object code saying where to find the Corresponding Source. Regardless of what server hosts the Corresponding Source, you remain obligated to ensure that it is available for as long as needed to satisfy these requirements.
- e. Convey the object code using peer-to-peer transmission, provided you inform other peers where the object code and Corresponding Source of the work are being offered to the general public at no charge under subsection 6d.

A separable portion of the object code, whose source code is excluded from the Corresponding Source as a System Library, need not be included in conveying the object code work.

A “User Product” is either (1) a “consumer product”, which means any tangible personal property which is normally used for personal, family, or household purposes, or (2) anything designed or sold for incorporation into a dwelling. In determining whether a product is a consumer product, doubtful cases shall be resolved in favor of coverage. For a particular product received by a particular user, “normally used” refers to a typical or common use of that class of product, regardless of the status of the particular user or of the way in which the particular user actually uses, or expects or is expected to use, the product. A product is a consumer product regardless of whether the product has substantial commercial, industrial or non-consumer uses, unless such uses represent the only significant mode of use of the product.

“Installation Information” for a User Product means any methods, procedures, authorization keys, or other information required to install and execute modified versions of a covered work in that User Product from a modified version of its Corresponding

Source. The information must suffice to ensure that the continued functioning of the modified object code is in no case prevented or interfered with solely because modification has been made.

If you convey an object code work under this section in, or with, or specifically for use in, a User Product, and the conveying occurs as part of a transaction in which the right of possession and use of the User Product is transferred to the recipient in perpetuity or for a fixed term (regardless of how the transaction is characterized), the Corresponding Source conveyed under this section must be accompanied by the Installation Information. But this requirement does not apply if neither you nor any third party retains the ability to install modified object code on the User Product (for example, the work has been installed in ROM).

The requirement to provide Installation Information does not include a requirement to continue to provide support service, warranty, or updates for a work that has been modified or installed by the recipient, or for the User Product in which it has been modified or installed. Access to a network may be denied when the modification itself materially and adversely affects the operation of the network or violates the rules and protocols for communication across the network.

Corresponding Source conveyed, and Installation Information provided, in accord with this section must be in a format that is publicly documented (and with an implementation available to the public in source code form), and must require no special password or key for unpacking, reading or copying.

7. Additional Terms.

“Additional permissions” are terms that supplement the terms of this License by making exceptions from one or more of its conditions. Additional permissions that are applicable to the entire Program shall be treated as though they were included in this License, to the extent that they are valid under applicable law. If additional permissions apply only to part of the Program, that part may be used separately under those permissions, but the entire Program remains governed by this License without regard to the additional permissions.

When you convey a copy of a covered work, you may at your option remove any additional permissions from that copy, or from any part of it. (Additional permissions may be written to require their own removal in certain cases when you modify the work.) You may place additional permissions on material, added by you to a covered work, for which you have or can give appropriate copyright permission.

Notwithstanding any other provision of this License, for material you add to a covered work, you may (if authorized by the copyright holders of that material) supplement the terms of this License with terms:

- a. Disclaiming warranty or limiting liability differently from the terms of sections 15 and 16 of this License; or
- b. Requiring preservation of specified reasonable legal notices or author attributions in that material or in the Appropriate Legal Notices displayed by works containing it; or
- c. Prohibiting misrepresentation of the origin of that material, or requiring that modified versions of such material be marked in reasonable ways as different from the original version; or
- d. Limiting the use for publicity purposes of names of licensors or authors of the material; or
- e. Declining to grant rights under trademark law for use of some trade names, trademarks, or service marks; or
- f. Requiring indemnification of licensors and authors of that material by anyone who conveys the material (or modified versions of it) with contractual assumptions of liability to the recipient, for any liability that these contractual assumptions directly impose on those licensors and authors.

All other non-permissive additional terms are considered “further restrictions” within the meaning of section 10. If the Program as you received it, or any part of it, contains a notice stating that it is governed by this License along with a term that is a further restriction, you may remove that term. If a license document contains a further restriction but permits relicensing or conveying under this License, you may add to a covered work material governed by the terms of that license document, provided that the further restriction does not survive such relicensing or conveying.

If you add terms to a covered work in accord with this section, you must place, in the relevant source files, a statement of the additional terms that apply to those files, or a notice indicating where to find the applicable terms.

Additional terms, permissive or non-permissive, may be stated in the form of a separately written license, or stated as exceptions; the above requirements apply either way.

8. Termination.

You may not propagate or modify a covered work except as expressly provided under this License. Any attempt otherwise to propagate or modify it is void, and will automatically terminate your rights under this License (including any patent licenses granted under the third paragraph of section 11).

However, if you cease all violation of this License, then your license from a particular copyright holder is reinstated (a) provisionally, unless and until the copyright holder explicitly and finally terminates your license, and (b) permanently, if the copyright holder fails to notify you of the violation by some reasonable means prior to 60 days after the cessation.

Moreover, your license from a particular copyright holder is reinstated permanently if the copyright holder notifies you of the violation by some reasonable means, this is the first time you have received notice of violation of this License (for any work) from that copyright holder, and you cure the violation prior to 30 days after your receipt of the notice.

Termination of your rights under this section does not terminate the licenses of parties who have received copies or rights from you under this License. If your rights have been terminated and not permanently reinstated, you do not qualify to receive new licenses for the same material under section 10.

9. Acceptance Not Required for Having Copies.

You are not required to accept this License in order to receive or run a copy of the Program. Ancillary propagation of a covered work occurring solely as a consequence of using peer-to-peer transmission to receive a copy likewise does not require acceptance. However, nothing other than this License grants you permission to propagate or modify any covered work. These actions infringe copyright if you do not accept this License. Therefore, by modifying or propagating a covered work, you indicate your acceptance of this License to do so.

10. Automatic Licensing of Downstream Recipients.

Each time you convey a covered work, the recipient automatically receives a license from the original licensors, to run, modify and propagate that work, subject to this License. You are not responsible for enforcing compliance by third parties with this License.

An “entity transaction” is a transaction transferring control of an organization, or substantially all assets of one, or subdividing an organization, or merging organizations. If propagation of a covered work results from an entity transaction, each party to that transaction who receives a copy of the work also receives whatever licenses to the work the party’s predecessor in interest had or could give under the previous paragraph, plus a right to possession of the Corresponding Source of the work from the predecessor in interest, if the predecessor has it or can get it with reasonable efforts.

You may not impose any further restrictions on the exercise of the rights granted or affirmed under this License. For example, you may not impose a license fee, royalty, or other charge for exercise of rights granted under this License, and you may not initiate litigation (including a cross-claim or counterclaim in a lawsuit) alleging that any patent claim is infringed by making, using, selling, offering for sale, or importing the Program or any portion of it.

11. Patents.

A “contributor” is a copyright holder who authorizes use under this License of the Program or a work on which the Program is based. The work thus licensed is called the contributor’s “contributor version”.

A contributor’s “essential patent claims” are all patent claims owned or controlled by the contributor, whether already acquired or hereafter acquired, that would be infringed by some manner, permitted by this License, of making, using, or selling its contributor version, but do not include claims that would be infringed only as a consequence of further modification of the contributor version. For purposes of this definition, “control” includes the right to grant patent sublicenses in a manner consistent with the requirements of this License.

Each contributor grants you a non-exclusive, worldwide, royalty-free patent license under the contributor's essential patent claims, to make, use, sell, offer for sale, import and otherwise run, modify and propagate the contents of its contributor version.

In the following three paragraphs, a "patent license" is any express agreement or commitment, however denominated, not to enforce a patent (such as an express permission to practice a patent or covenant not to sue for patent infringement). To "grant" such a patent license to a party means to make such an agreement or commitment not to enforce a patent against the party.

If you convey a covered work, knowingly relying on a patent license, and the Corresponding Source of the work is not available for anyone to copy, free of charge and under the terms of this License, through a publicly available network server or other readily accessible means, then you must either (1) cause the Corresponding Source to be so available, or (2) arrange to deprive yourself of the benefit of the patent license for this particular work, or (3) arrange, in a manner consistent with the requirements of this License, to extend the patent license to downstream recipients. "Knowingly relying" means you have actual knowledge that, but for the patent license, your conveying the covered work in a country, or your recipient's use of the covered work in a country, would infringe one or more identifiable patents in that country that you have reason to believe are valid.

If, pursuant to or in connection with a single transaction or arrangement, you convey, or propagate by procuring conveyance of, a covered work, and grant a patent license to some of the parties receiving the covered work authorizing them to use, propagate, modify or convey a specific copy of the covered work, then the patent license you grant is automatically extended to all recipients of the covered work and works based on it.

A patent license is "discriminatory" if it does not include within the scope of its coverage, prohibits the exercise of, or is conditioned on the non-exercise of one or more of the rights that are specifically granted under this License. You may not convey a covered work if you are a party to an arrangement with a third party that is in the business of distributing software, under which you make payment to the third party based on the extent of your activity of conveying the work, and under which the third party grants, to any of the parties who would receive the covered work from you, a discriminatory patent license (a) in connection with copies of the covered work conveyed by you (or copies made from those copies), or (b) primarily for and in connection with specific products or compilations that contain the covered work, unless you entered into that arrangement, or that patent license was granted, prior to 28 March 2007.

Nothing in this License shall be construed as excluding or limiting any implied license or other defenses to infringement that may otherwise be available to you under applicable patent law.

12. No Surrender of Others' Freedom.

If conditions are imposed on you (whether by court order, agreement or otherwise) that contradict the conditions of this License, they do not excuse you from the conditions of this License. If you cannot convey a covered work so as to satisfy simultaneously your obligations under this License and any other pertinent obligations, then as a consequence you may not convey it at all. For example, if you agree to terms that obligate you to collect a royalty for further conveying from those to whom you convey the Program, the only way you could satisfy both those terms and this License would be to refrain entirely from conveying the Program.

13. Use with the GNU Affero General Public License.

Notwithstanding any other provision of this License, you have permission to link or combine any covered work with a work licensed under version 3 of the GNU Affero General Public License into a single combined work, and to convey the resulting work. The terms of this License will continue to apply to the part which is the covered work, but the special requirements of the GNU Affero General Public License, section 13, concerning interaction through a network will apply to the combination as such.

14. Revised Versions of this License.

The Free Software Foundation may publish revised and/or new versions of the GNU General Public License from time to time. Such new versions will be similar in spirit to the present version, but may differ in detail to address new problems or concerns.

Each version is given a distinguishing version number. If the Program specifies that a certain numbered version of the GNU General Public License "or any later version" applies to it, you have the option of following the terms and conditions either of that

numbered version or of any later version published by the Free Software Foundation. If the Program does not specify a version number of the GNU General Public License, you may choose any version ever published by the Free Software Foundation.

If the Program specifies that a proxy can decide which future versions of the GNU General Public License can be used, that proxy's public statement of acceptance of a version permanently authorizes you to choose that version for the Program.

Later license versions may give you additional or different permissions. However, no additional obligations are imposed on any author or copyright holder as a result of your choosing to follow a later version.

15. Disclaimer of Warranty.

THERE IS NO WARRANTY FOR THE PROGRAM, TO THE EXTENT PERMITTED BY APPLICABLE LAW. EXCEPT WHEN OTHERWISE STATED IN WRITING THE COPYRIGHT HOLDERS AND/OR OTHER PARTIES PROVIDE THE PROGRAM "AS IS" WITHOUT WARRANTY OF ANY KIND, EITHER EXPRESSED OR IMPLIED, INCLUDING, BUT NOT LIMITED TO, THE IMPLIED WARRANTIES OF MERCHANTABILITY AND FITNESS FOR A PARTICULAR PURPOSE. THE ENTIRE RISK AS TO THE QUALITY AND PERFORMANCE OF THE PROGRAM IS WITH YOU. SHOULD THE PROGRAM PROVE DEFECTIVE, YOU ASSUME THE COST OF ALL NECESSARY SERVICING, REPAIR OR CORRECTION.

16. Limitation of Liability.

IN NO EVENT UNLESS REQUIRED BY APPLICABLE LAW OR AGREED TO IN WRITING WILL ANY COPYRIGHT HOLDER, OR ANY OTHER PARTY WHO MODIFIES AND/OR CONVEYS THE PROGRAM AS PERMITTED ABOVE, BE LIABLE TO YOU FOR DAMAGES, INCLUDING ANY GENERAL, SPECIAL, INCIDENTAL OR CONSEQUENTIAL DAMAGES ARISING OUT OF THE USE OR INABILITY TO USE THE PROGRAM (INCLUDING BUT NOT LIMITED TO LOSS OF DATA OR DATA BEING RENDERED INACCURATE OR LOSSES SUSTAINED BY YOU OR THIRD PARTIES OR A FAILURE OF THE PROGRAM TO OPERATE WITH ANY OTHER PROGRAMS), EVEN IF SUCH HOLDER OR OTHER PARTY HAS BEEN ADVISED OF THE POSSIBILITY OF SUCH DAMAGES.

17. Interpretation of Sections 15 and 16.

If the disclaimer of warranty and limitation of liability provided above cannot be given local legal effect according to their terms, reviewing courts shall apply local law that most closely approximates an absolute waiver of all civil liability in connection with the Program, unless a warranty or assumption of liability accompanies a copy of the Program in return for a fee.

END OF TERMS AND CONDITIONS

How to Apply These Terms to Your New Programs

If you develop a new program, and you want it to be of the greatest possible use to the public, the best way to achieve this is to make it free software which everyone can redistribute and change under these terms.

To do so, attach the following notices to the program. It is safest to attach them to the start of each source file to most effectively state the exclusion of warranty; and each file should have at least the "copyright" line and a pointer to where the full notice is found.

```
one line to give the program's name and a brief idea of what it does.
Copyright (C) year name of author
```

```
This program is free software: you can redistribute it and/or modify
it under the terms of the GNU General Public License as published by
the Free Software Foundation, either version 3 of the License, or
```

(at your option) any later version.

This program is distributed in the hope that it will be useful, but WITHOUT ANY WARRANTY; without even the implied warranty of MERCHANTABILITY or FITNESS FOR A PARTICULAR PURPOSE. See the GNU General Public License for more details.

You should have received a copy of the GNU General Public License along with this program. If not, see <http://www.gnu.org/licenses/>.

Also add information on how to contact you by electronic and paper mail.

If the program does terminal interaction, make it output a short notice like this when it starts in an interactive mode:

```
program Copyright (C) year name of author
This program comes with ABSOLUTELY NO WARRANTY; for details type `show w'.
This is free software, and you are welcome to redistribute it
under certain conditions; type `show c' for details.
```

The hypothetical commands ‘show w’ and ‘show c’ should show the appropriate parts of the General Public License. Of course, your program’s commands might be different; for a GUI interface, you would use an “about box”.

You should also get your employer (if you work as a programmer) or school, if any, to sign a “copyright disclaimer” for the program, if necessary. For more information on this, and how to apply and follow the GNU GPL, see <http://www.gnu.org/licenses/>.

The GNU General Public License does not permit incorporating your program into proprietary programs. If your program is a subroutine library, you may consider it more useful to permit linking proprietary applications with the library. If this is what you want to do, use the GNU Lesser General Public License instead of this License. But first, please read <http://www.gnu.org/philosophy/why-not-lgpl.html>.

Appendix E

GNU Free Documentation License

Version 1.3, 3 November 2008

Copyright © 2000, 2001, 2002, 2007, 2008 [Free Software Foundation, Inc.](#)

Everyone is permitted to copy and distribute verbatim copies of this license document, but changing it is not allowed.

0. PREAMBLE

The purpose of this License is to make a manual, textbook, or other functional and useful document “free” in the sense of freedom: to assure everyone the effective freedom to copy and redistribute it, with or without modifying it, either commercially or noncommercially. Secondly, this License preserves for the author and publisher a way to get credit for their work, while not being considered responsible for modifications made by others.

This License is a kind of “copyleft”, which means that derivative works of the document must themselves be free in the same sense. It complements the GNU General Public License, which is a copyleft license designed for free software.

We have designed this License in order to use it for manuals for free software, because free software needs free documentation: a free program should come with manuals providing the same freedoms that the software does. But this License is not limited to software manuals; it can be used for any textual work, regardless of subject matter or whether it is published as a printed book. We recommend this License principally for works whose purpose is instruction or reference.

1. APPLICABILITY AND DEFINITIONS

This License applies to any manual or other work, in any medium, that contains a notice placed by the copyright holder saying it can be distributed under the terms of this License. Such a notice grants a world-wide, royalty-free license, unlimited in duration, to use that work under the conditions stated herein. The “Document”, below, refers to any such manual or work. Any member of the public is a licensee, and is addressed as “you”. You accept the license if you copy, modify or distribute the work in a way requiring permission under copyright law.

A “Modified Version” of the Document means any work containing the Document or a portion of it, either copied verbatim, or with modifications and/or translated into another language.

A “Secondary Section” is a named appendix or a front-matter section of the Document that deals exclusively with the relationship of the publishers or authors of the Document to the Document’s overall subject (or to related matters) and contains nothing that could fall directly within that overall subject. (Thus, if the Document is in part a textbook of mathematics, a Secondary Section may not explain any mathematics.) The relationship could be a matter of historical connection with the subject or with related matters, or of legal, commercial, philosophical, ethical or political position regarding them.

The “Invariant Sections” are certain Secondary Sections whose titles are designated, as being those of Invariant Sections, in the notice that says that the Document is released under this License. If a section does not fit the above definition of Secondary then it is not allowed to be designated as Invariant. The Document may contain zero Invariant Sections. If the Document does not identify any Invariant Sections then there are none.

The “Cover Texts” are certain short passages of text that are listed, as Front-Cover Texts or Back-Cover Texts, in the notice that says that the Document is released under this License. A Front-Cover Text may be at most 5 words, and a Back-Cover Text may be at most 25 words.

A “Transparent” copy of the Document means a machine-readable copy, represented in a format whose specification is available to the general public, that is suitable for revising the document straightforwardly with generic text editors or (for images composed of pixels) generic paint programs or (for drawings) some widely available drawing editor, and that is suitable for input to text formatters or for automatic translation to a variety of formats suitable for input to text formatters. A copy made in an otherwise Transparent file format whose markup, or absence of markup, has been arranged to thwart or discourage subsequent modification by readers is not Transparent. An image format is not Transparent if used for any substantial amount of text. A copy that is not “Transparent” is called “Opaque”.

Examples of suitable formats for Transparent copies include plain ASCII without markup, Texinfo input format, LaTeX input format, SGML or XML using a publicly available DTD, and standard-conforming simple HTML, PostScript or PDF designed for human modification. Examples of transparent image formats include PNG, XCF and JPG. Opaque formats include proprietary formats that can be read and edited only by proprietary word processors, SGML or XML for which the DTD and/or processing tools are not generally available, and the machine-generated HTML, PostScript or PDF produced by some word processors for output purposes only.

The “Title Page” means, for a printed book, the title page itself, plus such following pages as are needed to hold, legibly, the material this License requires to appear in the title page. For works in formats which do not have any title page as such, “Title Page” means the text near the most prominent appearance of the work’s title, preceding the beginning of the body of the text.

The “publisher” means any person or entity that distributes copies of the Document to the public.

A section “Entitled XYZ” means a named subunit of the Document whose title either is precisely XYZ or contains XYZ in parentheses following text that translates XYZ in another language. (Here XYZ stands for a specific section name mentioned below, such as “Acknowledgements”, “Dedications”, “Endorsements”, or “History”.) To “Preserve the Title” of such a section when you modify the Document means that it remains a section “Entitled XYZ” according to this definition.

The Document may include Warranty Disclaimers next to the notice which states that this License applies to the Document. These Warranty Disclaimers are considered to be included by reference in this License, but only as regards disclaiming warranties: any other implication that these Warranty Disclaimers may have is void and has no effect on the meaning of this License.

2. VERBATIM COPYING

You may copy and distribute the Document in any medium, either commercially or noncommercially, provided that this License, the copyright notices, and the license notice saying this License applies to the Document are reproduced in all copies, and that you add no other conditions whatsoever to those of this License. You may not use technical measures to obstruct or control the reading or further copying of the copies you make or distribute. However, you may accept compensation in exchange for copies. If you distribute a large enough number of copies you must also follow the conditions in section 3.

You may also lend copies, under the same conditions stated above, and you may publicly display copies.

3. COPYING IN QUANTITY

If you publish printed copies (or copies in media that commonly have printed covers) of the Document, numbering more than 100, and the Document’s license notice requires Cover Texts, you must enclose the copies in covers that carry, clearly and legibly, all these Cover Texts: Front-Cover Texts on the front cover, and Back-Cover Texts on the back cover. Both covers must also clearly and legibly identify you as the publisher of these copies. The front cover must present the full title with all words of the title equally prominent and visible. You may add other material on the covers in addition. Copying with changes limited to the covers, as long as they preserve the title of the Document and satisfy these conditions, can be treated as verbatim copying in other respects.

If the required texts for either cover are too voluminous to fit legibly, you should put the first ones listed (as many as fit reasonably) on the actual cover, and continue the rest onto adjacent pages.

If you publish or distribute Opaque copies of the Document numbering more than 100, you must either include a machine-readable Transparent copy along with each Opaque copy, or state in or with each Opaque copy a computer-network location from which the general network-using public has access to download using public-standard network protocols a complete Transparent

copy of the Document, free of added material. If you use the latter option, you must take reasonably prudent steps, when you begin distribution of Opaque copies in quantity, to ensure that this Transparent copy will remain thus accessible at the stated location until at least one year after the last time you distribute an Opaque copy (directly or through your agents or retailers) of that edition to the public.

It is requested, but not required, that you contact the authors of the Document well before redistributing any large number of copies, to give them a chance to provide you with an updated version of the Document.

4. MODIFICATIONS

You may copy and distribute a Modified Version of the Document under the conditions of sections 2 and 3 above, provided that you release the Modified Version under precisely this License, with the Modified Version filling the role of the Document, thus licensing distribution and modification of the Modified Version to whoever possesses a copy of it. In addition, you must do these things in the Modified Version:

- A. Use in the Title Page (and on the covers, if any) a title distinct from that of the Document, and from those of previous versions (which should, if there were any, be listed in the History section of the Document). You may use the same title as a previous version if the original publisher of that version gives permission.
- B. List on the Title Page, as authors, one or more persons or entities responsible for authorship of the modifications in the Modified Version, together with at least five of the principal authors of the Document (all of its principal authors, if it has fewer than five), unless they release you from this requirement.
- C. State on the Title page the name of the publisher of the Modified Version, as the publisher.
- D. Preserve all the copyright notices of the Document.
- E. Add an appropriate copyright notice for your modifications adjacent to the other copyright notices.
- F. Include, immediately after the copyright notices, a license notice giving the public permission to use the Modified Version under the terms of this License, in the form shown in the Addendum below.
- G. Preserve in that license notice the full lists of Invariant Sections and required Cover Texts given in the Document's license notice.
- H. Include an unaltered copy of this License.
- I. Preserve the section Entitled "History", Preserve its Title, and add to it an item stating at least the title, year, new authors, and publisher of the Modified Version as given on the Title Page. If there is no section Entitled "History" in the Document, create one stating the title, year, authors, and publisher of the Document as given on its Title Page, then add an item describing the Modified Version as stated in the previous sentence.
- J. Preserve the network location, if any, given in the Document for public access to a Transparent copy of the Document, and likewise the network locations given in the Document for previous versions it was based on. These may be placed in the "History" section. You may omit a network location for a work that was published at least four years before the Document itself, or if the original publisher of the version it refers to gives permission.
- K. For any section Entitled "Acknowledgements" or "Dedications", Preserve the Title of the section, and preserve in the section all the substance and tone of each of the contributor acknowledgements and/or dedications given therein.
- L. Preserve all the Invariant Sections of the Document, unaltered in their text and in their titles. Section numbers or the equivalent are not considered part of the section titles.
- M. Delete any section Entitled "Endorsements". Such a section may not be included in the Modified Version.
- N. Do not retitle any existing section to be Entitled "Endorsements" or to conflict in title with any Invariant Section.
- O. Preserve any Warranty Disclaimers.

If the Modified Version includes new front-matter sections or appendices that qualify as Secondary Sections and contain no material copied from the Document, you may at your option designate some or all of these sections as invariant. To do this, add their titles to the list of Invariant Sections in the Modified Version's license notice. These titles must be distinct from any other section titles.

You may add a section Entitled "Endorsements", provided it contains nothing but endorsements of your Modified Version by various parties — for example, statements of peer review or that the text has been approved by an organization as the authoritative definition of a standard.

You may add a passage of up to five words as a Front-Cover Text, and a passage of up to 25 words as a Back-Cover Text, to the end of the list of Cover Texts in the Modified Version. Only one passage of Front-Cover Text and one of Back-Cover Text may be added by (or through arrangements made by) any one entity. If the Document already includes a cover text for the same cover, previously added by you or by arrangement made by the same entity you are acting on behalf of, you may not add another; but you may replace the old one, on explicit permission from the previous publisher that added the old one.

The author(s) and publisher(s) of the Document do not by this License give permission to use their names for publicity for or to assert or imply endorsement of any Modified Version.

5. COMBINING DOCUMENTS

You may combine the Document with other documents released under this License, under the terms defined in section 4 above for modified versions, provided that you include in the combination all of the Invariant Sections of all of the original documents, unmodified, and list them all as Invariant Sections of your combined work in its license notice, and that you preserve all their Warranty Disclaimers.

The combined work need only contain one copy of this License, and multiple identical Invariant Sections may be replaced with a single copy. If there are multiple Invariant Sections with the same name but different contents, make the title of each such section unique by adding at the end of it, in parentheses, the name of the original author or publisher of that section if known, or else a unique number. Make the same adjustment to the section titles in the list of Invariant Sections in the license notice of the combined work.

In the combination, you must combine any sections Entitled "History" in the various original documents, forming one section Entitled "History"; likewise combine any sections Entitled "Acknowledgements", and any sections Entitled "Dedications". You must delete all sections Entitled "Endorsements".

6. COLLECTIONS OF DOCUMENTS

You may make a collection consisting of the Document and other documents released under this License, and replace the individual copies of this License in the various documents with a single copy that is included in the collection, provided that you follow the rules of this License for verbatim copying of each of the documents in all other respects.

You may extract a single document from such a collection, and distribute it individually under this License, provided you insert a copy of this License into the extracted document, and follow this License in all other respects regarding verbatim copying of that document.

7. AGGREGATION WITH INDEPENDENT WORKS

A compilation of the Document or its derivatives with other separate and independent documents or works, in or on a volume of a storage or distribution medium, is called an "aggregate" if the copyright resulting from the compilation is not used to limit the legal rights of the compilation's users beyond what the individual works permit. When the Document is included in an aggregate, this License does not apply to the other works in the aggregate which are not themselves derivative works of the Document.

If the Cover Text requirement of section 3 is applicable to these copies of the Document, then if the Document is less than one half of the entire aggregate, the Document's Cover Texts may be placed on covers that bracket the Document within the aggregate, or the electronic equivalent of covers if the Document is in electronic form. Otherwise they must appear on printed covers that bracket the whole aggregate.

8. TRANSLATION

Translation is considered a kind of modification, so you may distribute translations of the Document under the terms of section 4. Replacing Invariant Sections with translations requires special permission from their copyright holders, but you may include translations of some or all Invariant Sections in addition to the original versions of these Invariant Sections. You may include a translation of this License, and all the license notices in the Document, and any Warranty Disclaimers, provided that you also include the original English version of this License and the original versions of those notices and disclaimers. In case of a disagreement between the translation and the original version of this License or a notice or disclaimer, the original version will prevail.

If a section in the Document is Entitled “Acknowledgements”, “Dedications”, or “History”, the requirement (section 4) to Preserve its Title (section 1) will typically require changing the actual title.

9. TERMINATION

You may not copy, modify, sublicense, or distribute the Document except as expressly provided under this License. Any attempt otherwise to copy, modify, sublicense, or distribute it is void, and will automatically terminate your rights under this License.

However, if you cease all violation of this License, then your license from a particular copyright holder is reinstated (a) provisionally, unless and until the copyright holder explicitly and finally terminates your license, and (b) permanently, if the copyright holder fails to notify you of the violation by some reasonable means prior to 60 days after the cessation.

Moreover, your license from a particular copyright holder is reinstated permanently if the copyright holder notifies you of the violation by some reasonable means, this is the first time you have received notice of violation of this License (for any work) from that copyright holder, and you cure the violation prior to 30 days after your receipt of the notice.

Termination of your rights under this section does not terminate the licenses of parties who have received copies or rights from you under this License. If your rights have been terminated and not permanently reinstated, receipt of a copy of some or all of the same material does not give you any rights to use it.

10. FUTURE REVISIONS OF THIS LICENSE

The Free Software Foundation may publish new, revised versions of the GNU Free Documentation License from time to time. Such new versions will be similar in spirit to the present version, but may differ in detail to address new problems or concerns. See [Copyleft](#).

Each version of the License is given a distinguishing version number. If the Document specifies that a particular numbered version of this License “or any later version” applies to it, you have the option of following the terms and conditions either of that specified version or of any later version that has been published (not as a draft) by the Free Software Foundation. If the Document does not specify a version number of this License, you may choose any version ever published (not as a draft) by the Free Software Foundation. If the Document specifies that a proxy can decide which future versions of this License can be used, that proxy’s public statement of acceptance of a version permanently authorizes you to choose that version for the Document.

11. RELICENSING

“Massive Multiauthor Collaboration Site” (or “MMC Site”) means any World Wide Web server that publishes copyrightable works and also provides prominent facilities for anybody to edit those works. A public wiki that anybody can edit is an example of such a server. A “Massive Multiauthor Collaboration” (or “MMC”) contained in the site means any set of copyrightable works thus published on the MMC site.

“CC-BY-SA” means the Creative Commons Attribution-Share Alike 3.0 license published by Creative Commons Corporation, a not-for-profit corporation with a principal place of business in San Francisco, California, as well as future copyleft versions of that license published by that same organization.

“Incorporate” means to publish or republish a Document, in whole or in part, as part of another Document.

An MMC is “eligible for relicensing” if it is licensed under this License, and if all works that were first published under this License somewhere other than this MMC, and subsequently incorporated in whole or in part into the MMC, (1) had no cover texts or invariant sections, and (2) were thus incorporated prior to November 1, 2008.

The operator of an MMC Site may republish an MMC contained in the site under CC-BY-SA on the same site at any time before August 1, 2009, provided the MMC is eligible for relicensing.

ADDENDUM: How to use this License for your documents

To use this License in a document you have written, include a copy of the License in the document and put the following copyright and license notices just after the title page:

```
Copyright © YEAR YOUR NAME
```

```
Permission is granted to copy, distribute and/or modify this document under the
terms of the GNU Free Documentation License, Version 1.3 or any later version
published by the Free Software Foundation; with no Invariant Sections, no
Front-Cover Texts, and no Back-Cover Texts. A copy of the license is included in
the section entitled "GNU Free Documentation License".
```

If you have Invariant Sections, Front-Cover Texts and Back-Cover Texts, replace the “with... Texts.” line with this:

```
with the Invariant Sections being LIST THEIR TITLES, with the Front-Cover Texts
being LIST, and with the Back-Cover Texts being LIST.
```

If you have Invariant Sections without Cover Texts, or some other combination of the three, merge those two alternatives to suit the situation.

If your document contains nontrivial examples of program code, we recommend releasing these examples in parallel under your choice of free software license, such as the GNU General Public License, to permit their use in free software.

Chapter 31

Index

A

Algorithms, [88](#)

Appendix

Contributing, [286](#)

Free Documentation, [372](#)

Porting and Maintenance, [315](#)

Atomics, [98](#)

C

Concurrency, [99](#)

Containers, [80](#)

D

Diagnostics, [45](#)

E

Extensions, [100](#)

I

Input and Output, [91](#)

Introduction, [1](#)

Iterators, [86](#)

L

Localization, [63](#)

N

Numerics, [89](#)

S

Strings, [57](#)

Support, [40](#)

T

Test

Exception Safety, [339](#)

U

Utilities, [47](#)